



PIMTAS®

PLASTİK İNŞ. MALZ. SAN. VE TİC. A.Ş.



U-PVC / HDPE / PP

ÜRÜN KATALOGU PRODUCT CATALOGUE

Алматы (7273)495-231
Ангарск (3955)60-70-56
Архангельск (8182)63-90-72
Астрахань (8512)99-46-04
Барнаул (3852)73-04-60
Белгород (4722)40-23-64
Благовещенск (4162)22-76-07
Брянск (4832)59-03-52
Владивосток (423)249-28-31
Владикавказ (8672)28-90-48
Владимир (4922)49-43-18
Волгоград (844)278-03-48
Вологда (8172)26-41-59
Воронеж (473)204-51-73
Екатеринбург (343)384-55-89

Иваново (4932)77-34-06
Ижевск (3412)26-03-58
Иркутск (395)279-98-46
Казань (843)206-01-48
Калининград (4012)72-03-81
Калуга (4842)92-23-67
Кемерово (3842)65-04-62
Киров (8332)68-02-04
Коломна (4966)23-41-49
Кострома (4942)77-07-48
Краснодар (861)203-40-90
Красноярск (391)204-63-61
Курск (4712)77-13-04
Курган (3522)50-90-47
Липецк (4742)52-20-81

Магнитогорск (3519)55-03-13
Москва (495)268-04-70
Мурманск (8152)59-64-93
Набережные Челны (8552)20-53-41
Нижний Новгород (831)429-08-12
Новокузнецк (3843)20-46-81
Ноябрьск (3496)41-32-12
Новосибирск (383)227-86-73
Омск (3812)21-46-40
Орел (4862)44-53-42
Оренбург (3532)37-68-04
Пенза (8412)22-31-16
Петрозаводск (8142)55-98-37
Псков (8112)59-10-37
Пермь (342)205-81-47

Ростов-на-Дону (863)308-18-15
Рязань (4912)46-61-64
Самара (846)206-03-16
Санкт-Петербург (812)309-46-40
Саратов (845)249-38-78
Севастополь (8692)22-31-93
Саранск (8342)22-96-24
Симферополь (3652)67-13-56
Смоленск (4812)29-41-54
Сочи (862)225-72-31
Ставрополь (8652)20-65-13
Сургут (3462)77-98-35
Сыктывкар (8212)25-95-17
Тамбов (4752)50-40-97
Тверь (4822)63-31-35

Тольятти (8482)63-91-07
Томск (3822)98-41-53
Тула (4872)33-79-87
Тюмень (3452)66-21-18
Ульяновск (8422)24-23-59
Улан-Удэ (3012)59-97-51
Уфа (347)229-48-12
Хабаровск (4212)92-98-04
Чебоксары (8352)28-53-07
Челябинск (351)202-03-61
Череповец (8202)49-02-64
Чита (3022)38-34-83
Якутск (4112)23-90-97
Ярославль (4852)69-52-93

Россия +7(495)268-04-70

Казахстан +7(7172)727-132

Киргизия +996(312)96-26-47

<https://pimtas.nt-rt.ru/> || pab@nt-rt.ru

İÇİNDEKİLER / INDEX

22-23	HAKKIMIZDA / ABOUT US
24-25	SERTİFİKALAR / CERTIFICATE
26-27	KİMYASALLARA DAYANIM / RESISTANCE TO CHEMICALS
29-36	U-PVC BORULAR / PIPE
37-52	U-PVC DEVE BOYNU BORULAR / LONG BEND PIPES
53-60	KELEPÇELER / PIPE CLAMP
61-68	TEKNİK MALZEMELER / TECHNICAL MATERIALS
69-74	U-PVC CONTALI EK PARÇALAR / GASKET SOCKETED FITTINGS
75-94	U-PVC EK PARÇALAR / FITTINGS
95-100	U-PVC RAKOR / UNION
101-110	U-PVC ÇEKVALF / CHECKVALVE
111-116	U-PVC KELEBEK VANALAR / BUTTERFLY VALVE
117-134	U-PVC AKTÜATÖRLÜ KELEBEK VANALAR / ACTUATOR BUTTERFLY VALVE
135-148	U-PVC KÜRESEL VANALAR / BALL VALVE
149-160	U-PVC AKTÜATÖRLÜ KÜRESEL VANALAR / ACTUATOR BALL VALVE
161-170	HDPE BORU / PIPE
171-178	HDPE VANA / VALVE
179-184	HDPE EF EK PARÇALAR / EF FITTINGS
185-198	HDPE SPİGOT EK PARÇALAR / SPIGOT FITTINGS
199-208	HDPE KONFEKSİYON EK PARÇALAR / HAND-MADE FITTINGS
209-214	PP-B KAPLIN VANALAR / COMPRESSION VALVES
215-228	PP-B KAPLIN MAVİ SERİ / COMPRESSION BLUE SERIES
229-238	PP-B KAPLIN YEŞİL SERİ / COMPRESSION GREEN SERIES
239-240	PP VANA KUTULARI / VALVE BOXES
241-252	U-PVC / PP PRİZ KOLYE / CLAMP SADDLE
253-256	MANDALLI YAĞMURLAMA BORU ve EK PARÇALARI / LATCHED IRRIGATION PIPE AND FITTINGS
257-262	DAMLA SULAMA BORULARI / DRIP IRRIGATION PIPE
263-274	DAMLA SULAMA ÜRÜNLERİ / DRIP IRRIGATION PRODUCT LINE
275-294	PP ÜRÜN GRUBU / PRODUCT LINE
295-320	PPRC ÜRÜN GRUBU / PRODUCT LINE
321-337	YEDEK PARÇALAR / SPARE PARTS

U-PVC BORULAR / U-PVC PIPES



sayfa/page: 32-33



sayfa/page: 34-35



sayfa/page: 36



sayfa/page: 37



sayfa/page: 37

U-PVC DEVEBOYNU BORULAR / U-PVC PIPES



sayfa/page: 38



sayfa/page: 39



sayfa/page: 40



sayfa/page: 41



sayfa/page: 42



sayfa/page: 43



sayfa/page: 44



sayfa/page: 45



sayfa/page: 46



sayfa/page: 47



sayfa/page: 48



sayfa/page: 49



sayfa/page: 50



sayfa/page: 51



sayfa/page: 51

KELEPÇELER / PIPE CLAMP



sayfa/page: 52



sayfa/page: 52



sayfa/page: 52



sayfa/page: 53



sayfa/page: 54



sayfa/page: 54



sayfa/page: 55



sayfa/page: 55



sayfa/page: 55



sayfa/page: 56



sayfa/page: 56



sayfa/page: 56



sayfa/page: 57



sayfa/page: 57



sayfa/page: 57



sayfa/page: 57

TEKNİK MALZEMELER / TECHNICAL MATERIALS



sayfa/page: 60



sayfa/page: 60



sayfa/page: 61

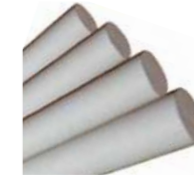

sayfa/page: 62



sayfa/page: 63



sayfa/page: 64



sayfa/page: 64-65



sayfa/page: 65



sayfa/page: 65



sayfa/page: 65



sayfa/page: 65



sayfa/page: 65

U-PVC CONTALI EK PARÇALAR / U-PVC GASKET SOCKETED FITTINGS



sayfa/page: 68



sayfa/page: 68



sayfa/page: 68



sayfa/page: 68



sayfa/page: 69



sayfa/page: 69



sayfa/page: 69



sayfa/page: 70



sayfa/page: 70



sayfa/page: 71



sayfa/page: 71



sayfa/page: 72



sayfa/page: 72



sayfa/page: 74



sayfa/page: 74



sayfa/page: 74



sayfa/page: 75



sayfa/page: 75



sayfa/page: 76



sayfa/page: 76



sayfa/page:77



sayfa/page:77



sayfa/page:78-79



sayfa/page:79



sayfa/page:79



sayfa/page: 80



sayfa/page: 80-81



sayfa/page: 80-81



sayfa/page: 81



sayfa/page: 82



sayfa/page: 82



sayfa/page: 82



sayfa/page: 82



sayfa/page: 83



sayfa/page: 83



sayfa/page: 83



sayfa/page: 83

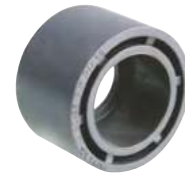

sayfa/page: 84



sayfa/page: 84



sayfa/page: 85



sayfa/page: 85



sayfa/page: 86



sayfa/page: 86



sayfa/page: 86



sayfa/page: 87



sayfa/page: 87

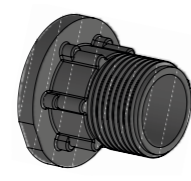

sayfa/page: 87



sayfa/page: 88



sayfa/page: 88



sayfa/page: 88



sayfa/page: 89



sayfa/page: 89



sayfa/page: 90



sayfa/page: 90



sayfa/page: 90



sayfa/page: 91



sayfa/page: 91



sayfa/page: 91

U-PVC RAKOR / U-PVC UNION



sayfa/page: 94



sayfa/page: 94-95



sayfa/page: 95



sayfa/page: 95



sayfa/page: 96



sayfa/page: 96



sayfa/page: 96



sayfa/page: 96



sayfa/page: 97



sayfa/page: 97



sayfa/page: 97



sayfa/page: 97



sayfa/page: 98



sayfa/page: 98



sayfa/page: 98

U-PVC ÇEKVALF / U-PVC HECKVALVE

U-PVC AKTÜATÖRLÜ KELEBEK VANA / U-PVC ACTUATOR BUTTERFLY VALVE

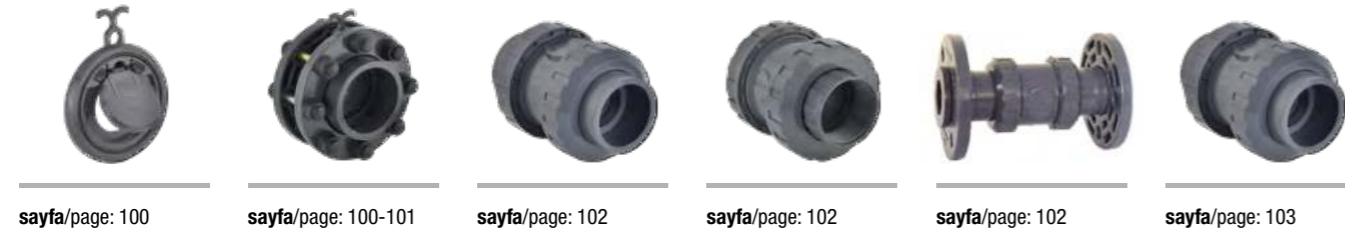

U-PVC KÜRESEL VANA / U-PVC BALL VALVE



U-PVC KELEBEK VANA / U-PVC BUTTERFLY VALVE

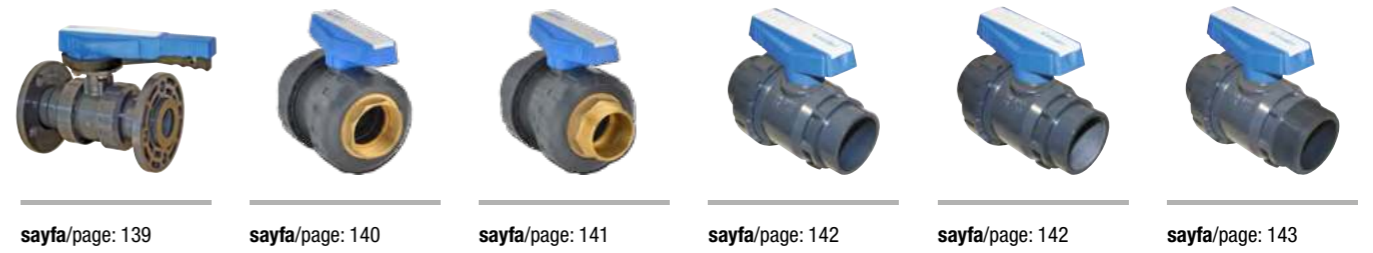

U-PVC AKTÜATÖRLÜ KÜRESEL VANA / U-PVC ACTUATOR BALL VALVE



sayfa/page: 150



sayfa/page: 150-151



sayfa/page: 151



sayfa/page: 152,155



sayfa/page: 153



sayfa/page: 156,159



sayfa/page: 157

HDPE EF EK PARÇALAR / HDPE EF FITTINGS



sayfa/page: 182



sayfa/page: 182



sayfa/page: 182



sayfa/page: 183



sayfa/page: 183



sayfa/page: 183



sayfa/page: 184



sayfa/page: 185

HDPE BORU-VANA / HDPE PIPE-VALVE



sayfa/page: 164,168



sayfa/page: 169,171



sayfa/page:174-145



sayfa/page:174



sayfa/page:175



sayfa/page: 176



sayfa/page: 176



sayfa/page: 177



sayfa/page: 177



sayfa/page: 177



sayfa/page: 177-179



sayfa/page: 178



sayfa/page: 178



sayfa/page: 178



sayfa/page: 179

HDPE SPİGOT ENJEKSİYON EK PARÇALAR / HDPE SPIGOT INJECTION FITTINGS



sayfa/page: 188



sayfa/page: 189



sayfa/page: 190



sayfa/page: 191



sayfa/page: 192-193



sayfa/page: 194



sayfa/page: 195



sayfa/page: 196-197



sayfa/page: 198



sayfa/page: 198



sayfa/page: 199



sayfa/page: 199



sayfa/page: 199

HDPE KONFEKSİYON EK PARÇALAR / HDPE CONFECTION FITTINGS

PP-B KAPLİN MAVİ SERİ / PP-B COMPRESSIONS BLUE SERIES



PP-B KAPLİN VANALAR / PP-B COMPRESSIONS VALVES

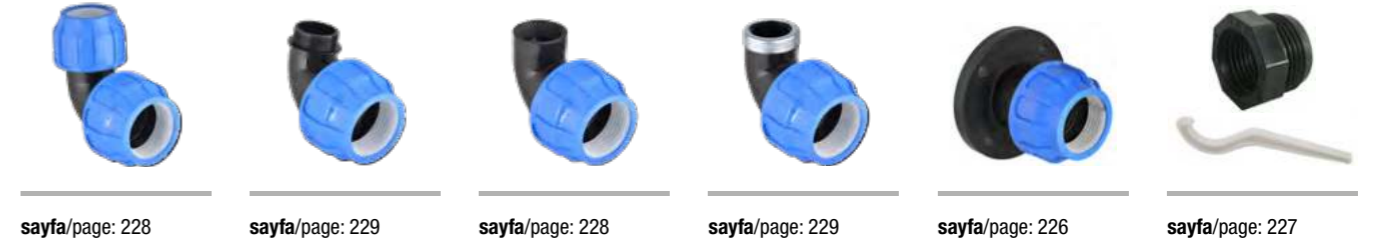
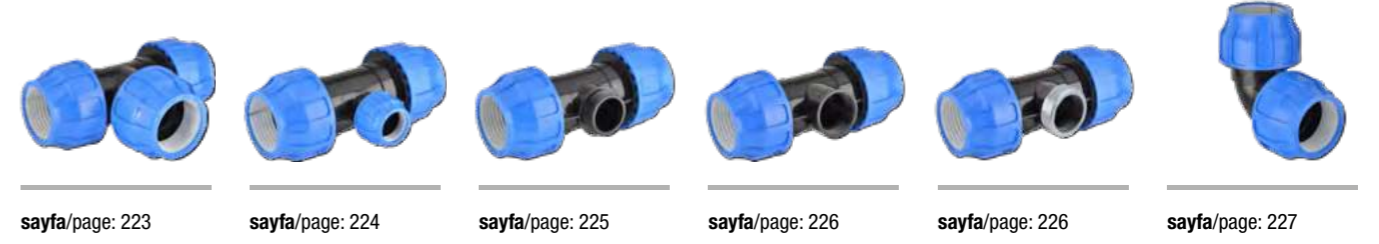
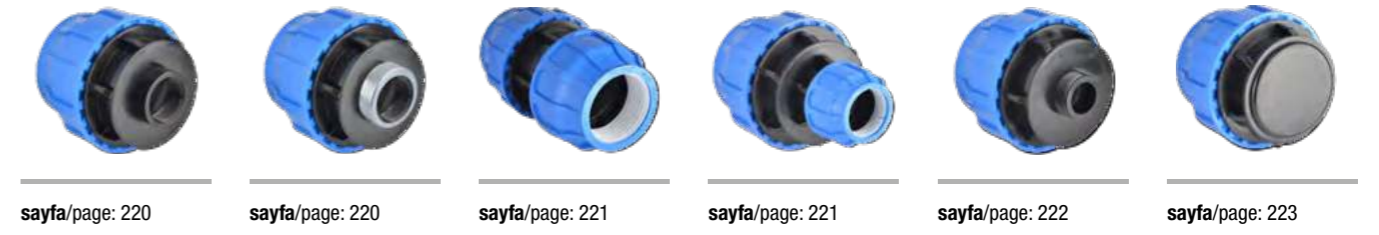
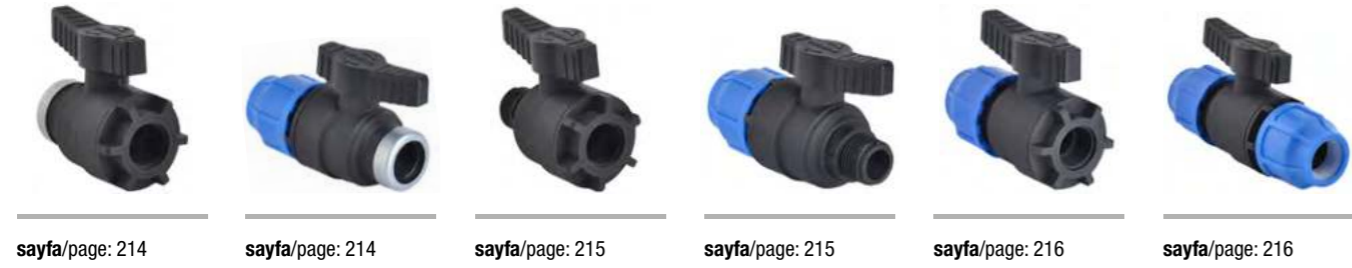

PP-B KAPLİN YEŞİL SERİ / PP-B COMPRESSIONS GREEN SERIES

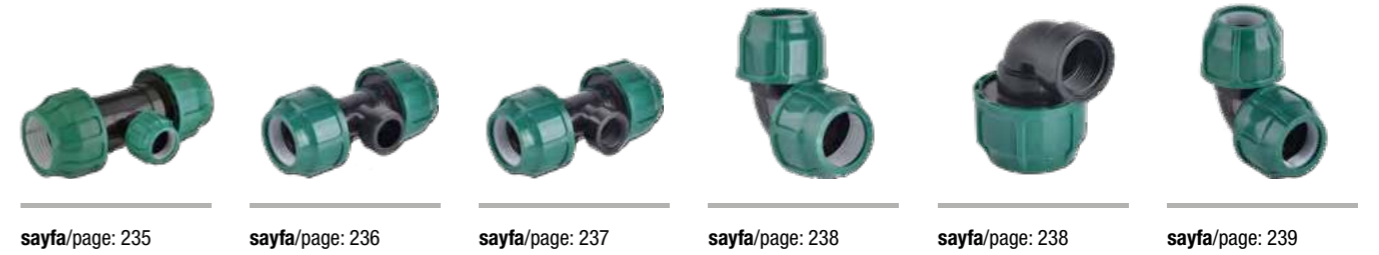

PP VANA KUTULARI / VALVE BOXES



sayfa/page: 242

sayfa/page: 242

sayfa/page: 242

sayfa/page: 242

DAMLA SULAMA BORU-EKPARÇA / DRIP IRRIGATION PIPE-FITTINGS

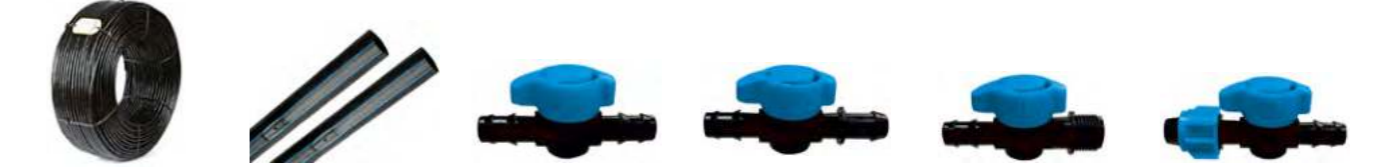

sayfa/page: 262-263

sayfa/page: 264- 265

sayfa/page: 268

sayfa/page: 268

sayfa/page: 268

sayfa/page: 268

PVC/PP PRİZ KOLYE / PVC/PP CLAMP SADDLES



sayfa/page: 246

sayfa/page: 246

sayfa/page: 248

sayfa/page: 249

sayfa/page: 250

sayfa/page: 251



sayfa/page: 268

sayfa/page: 268

sayfa/page: 268

sayfa/page: 269

sayfa/page: 269

sayfa/page: 269



sayfa/page: 252

sayfa/page: 253

sayfa/page: 254

sayfa/page: 255

sayfa/page: 256

sayfa/page: 256



sayfa/page: 269

sayfa/page: 269

sayfa/page: 269

sayfa/page: 269

sayfa/page: 270

sayfa/page: 270



sayfa/page: 270

sayfa/page: 270

sayfa/page: 270

sayfa/page: 270

sayfa/page: 270

sayfa/page: 270

MANDALLI YAĞMURLAMA BORU ve EK PARÇALARI / LATCHED IRRIGATION PIPE AND FITTINGS



sayfa/page: 258

sayfa/page: 258

sayfa/page: 258

sayfa/page: 259

sayfa/page: 259

sayfa/page: 259



sayfa/page: 271

sayfa/page: 271

sayfa/page: 271

sayfa/page: 271

sayfa/page: 271

sayfa/page: 271



sayfa/page: 259

sayfa/page: 259

sayfa/page: 259

sayfa/page: 260

sayfa/page: 260

sayfa/page: 260



sayfa/page: 271

sayfa/page: 272

sayfa/page: 272

sayfa/page: 272

sayfa/page: 272

sayfa/page: 272



sayfa/page: 272



sayfa/page: 272



sayfa/page: 273



sayfa/page: 273



sayfa/page: 273



sayfa/page: 273



sayfa/page: 280



sayfa/page: 280-281



sayfa/page: 282



sayfa/page: 282-283



sayfa/page: 284



sayfa/page: 284-285



sayfa/page: 273



sayfa/page: 274



sayfa/page: 274



sayfa/page: 274



sayfa/page: 274



sayfa/page: 274



sayfa/page: 285



sayfa/page: 286-287



sayfa/page: 286-287



sayfa/page: 288



sayfa/page: 288-289



sayfa/page: 290



sayfa/page: 274



sayfa/page: 274



sayfa/page: 275



sayfa/page: 275



sayfa/page: 275



sayfa/page: 275



sayfa/page: 290



sayfa/page: 291



sayfa/page: 291



sayfa/page: 292



sayfa/page: 292-293



sayfa/page: 293



sayfa/page: 275



sayfa/page: 275



sayfa/page: 275



sayfa/page: 275



sayfa/page: 276



sayfa/page: 276



sayfa/page: 294



sayfa/page: 294-295



sayfa/page: 296



sayfa/page: 296



sayfa/page: 296



sayfa/page: 297



sayfa/page: 276



sayfa/page: 276



sayfa/page: 277



sayfa/page: 277



sayfa/page: 277



sayfa/page: 277



sayfa/page: 297



sayfa/page: 278



sayfa/page: 278

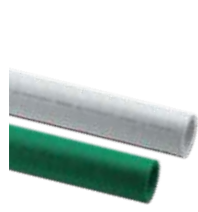

sayfa/page: 298



sayfa/page: 299



sayfa/page: 299



sayfa/page: 300



sayfa/page: 300



sayfa/page: 300



sayfa/page: 308



sayfa/page: 309



sayfa/page: 309



sayfa/page: 309



sayfa/page: 309



sayfa/page: 309



sayfa/page: 300



sayfa/page: 300



sayfa/page: 301



sayfa/page: 301



sayfa/page: 301



sayfa/page: 302



sayfa/page: 310



sayfa/page: 310



sayfa/page: 310



sayfa/page: 310



sayfa/page: 310



sayfa/page: 310



sayfa/page: 302



sayfa/page: 302



sayfa/page: 303



sayfa/page: 303



sayfa/page: 303



sayfa/page: 303



sayfa/page: 311



sayfa/page: 311



sayfa/page: 311



sayfa/page: 311



sayfa/page: 311



sayfa/page: 312



sayfa/page: 304



sayfa/page: 305



sayfa/page: 305



sayfa/page: 305



sayfa/page: 305



sayfa/page: 306



sayfa/page: 312



sayfa/page: 312



sayfa/page: 312



sayfa/page: 313



sayfa/page: 313



sayfa/page: 313



sayfa/page: 306



sayfa/page: 306



sayfa/page: 306



sayfa/page: 307



sayfa/page: 307



sayfa/page: 307



sayfa/page: 313



sayfa/page: 314



sayfa/page: 314



sayfa/page: 314



sayfa/page: 314



sayfa/page: 314



sayfa/page: 307



sayfa/page: 307



sayfa/page: 308



sayfa/page: 308



sayfa/page: 308



sayfa/page: 308



sayfa/page: 315



sayfa/page: 315



sayfa/page: 315



sayfa/page: 315



sayfa/page: 315



sayfa/page: 316



sayfa/page: 316



sayfa/page: 316



sayfa/page: 316



sayfa/page: 316



sayfa/page: 316



sayfa/page: 317



sayfa/page: 317



sayfa/page: 317



sayfa/page: 317



sayfa/page: 317



sayfa/page: 317



sayfa/page: 318



sayfa/page: 318



sayfa/page: 318



sayfa/page: 318



sayfa/page: 318



sayfa/page: 318



sayfa/page: 319



sayfa/page: 319



sayfa/page: 319



sayfa/page: 319



sayfa/page: 319



sayfa/page: 320



sayfa/page: 320



sayfa/page: 320



sayfa/page: 321



sayfa/page: 321



sayfa/page: 321



sayfa/page: 321



sayfa/page: 322



sayfa/page: 322



sayfa/page: 322



sayfa/page: 322



U-PVC/UH-PVC ÜRÜN GRUBU PRODUCT LINE - SAYFA PAGE: 29-108



U-PVC/UH-PVC VANA ÜRÜN GRUBU VALVE PRODUCT LINE - SAYFA PAGE: 109-160



HDPE ÜRÜN GRUBU PRODUCT LINE - SAYFA PAGE: 161-210



PP-B KAPLİN ÜRÜN GRUBU COMPRESSION PRODUCT LINE - SAYFA PAGE: 211-242



PP/PPRC ÜRÜN GRUBU PRODUCT LINE - SAYFA PAGE: 279-322

PİMTAŞ A.Ş. 1977 yılında kurulmuş olup, üretime başladığı andan itibaren plastik inşaat malzemelerinin (Boru, Ek parça, Küresel Vana, Kelebek Vana, Çekvalf, Rakor, Havuz ve Tesisat teknik ekipmanları) kendine özgü tasarımını ve imalatını yapan, plastik sektöründeki uluslararası öncü kuruluşlardan biridir.

PİMTAŞ A.Ş. kullanmış olduğu üretim teknolojisini geliştirerek mevcut üretimini Batı Avrupa' da kullanılan teknoloji normlarına uyarlamıştır. Üretim programı her türlü inşaat problemini çözecek ek parça ve yardımcı malzemelerini kapsamaktadır. Avrupa ve Gümrük Birliğine geçmiş olmanın bilinci ile teknoloji ve kalitede Avrupa'nın en iyi firmaları ile rekabet eden bir üretim gerçekleştirmektedir.

Bugün Pimtaş Plastik , ISO 9001 kalite yönetim sistemine ve TSE Belgesine sahip olarak en yeni teknolojik altyapı, makine ve kalıp sistemleri ile başta Avrupa ülkeleri başta olmak üzere 105 ayrı ülkeye ihracat yapan ve 81 ilde tüketicinin memnuniyetini ve güvenini kazanmış bir firmadır.

550'yi aşkın tecrübeli çalışanı ile 7/24 hizmet vermektedir. 1977 yılından beri siz değerli müşterilerimize daha kaliteli ürünler ve hizmetler sunabilmek için üretiyor ve her geçen yıl kendini yenilemeye devam ediyor.

Vizyonumuz

Sürekli gelişim hedefi ile sektöründe bir dünya şirketi olmak.

Misyonumuz

Biz, ürettiğimiz ürünlerle insan medeniyetinin alt yapısına hizmet ediyoruz.

Yeryüzünde İnsan hayatına suyun rahat, güvenilir ve standartlara uygun bir şekilde ulaşmasını sağlıyoruz. Ürettiğimiz ürünlerle, insanların temel ihtiyaçlarının karşılanmasından, kaliteli ve konforlu bir yaşamın oluşmasına ve sürdürülmesine kadar tüm yaşam alanlarına destek oluyoruz.

Tarım, Turizm, İnşaat ve altyapı sektörlerindeki müşterilerimizin bize duyduğu güvene; kaliteli, hızlı ve ulaşılabilir plastik boru ve bağlantı ekipmanları üreterek cevap veriyoruz.

PİMTAŞ A.Ş. was established in 1977, and is now one of the leading international companies in the plastic sector that has been designing and manufacturing plastic construction materials (Pipes,Fittings, Ball Valves, Butterfly Valves, Check Valves, Fittings, Pool and Plumbing technical equipment) since the moment it started production.

PİMTAŞ A.Ş. has adapted its current production to the technology standards used in Western Europe by improving its production technology. The production program includes additional parts and auxiliary materials that can solve all kinds of construction problems. With the awareness of being transferred to Europe and the Customs Union, it realizes a production that competes with Europe's best companies in technology and quality.

Today, Pimtaş Plastik is a company that has ISO 9001 quality management system and TSE Certificate and exports to 105 different countries, mostly to European countries, with the latest technological infrastructure, machinery and mold systems, and gained the satisfaction and trust of consumers in 81 provinces.Pimtaş provides 24/7 service with the help of more than 550 experienced employees. It has been producing since 1977 to provide better quality products and services to our valued customers and continues to renew itself every year.

Our Vision

To become a global company in field with the target of constant development.

Our Mission

We serve the infrastructure of human civilization with the products we produce.We ensure that water reaches human life comfortably, reliably and in accordance with the standards. With the products we produce, we support all living spaces, from meeting basic needs to the creation and maintenance of a quality and comfortable life.

The trust of our customers in the agriculture, tourism, construction and infrastructure sectors; We respond by producing high quality, fast and accessible plastic pipes and connection equipment.

PİMTAŞ 1



PİMTAŞ 2



PİMTAŞ 3



PİMTAŞ 4



PİMTAŞ 5



PİMTAŞ 6



PİMTAŞ 7



PİMTAŞ 8



KİMYASALLARA DAYANIM RESISTANCE TO CHEMICALS

U-PVC BORULARIN KİMYASAL MADDELERE DAYANIM TABLOSU

TABLE FOR RESISTANCE OF U-PVC PIPES TO CHEMICAL SUBSTANCES

Aşağıdaki tablo'dan da görüleceği üzere, U-PVC Borular bir çok kimyasal ve hemen hemen bütün asitlere karşı çok iyi dayanıma sahiptir. Aşağıdaki tabloda verilen dayanıklılık bilgileri 20°C sıcaklıkta geçerlidir. U-PVC borular, daha yüksek sıcaklıklarda daha değişik davranış gösterebilir. U-PVC boruların diğer kimyasallara karşı ve daha yüksek sıcaklıklardaki dayanıklılık durumları hakkındaki bilgileri firmamızdan temin edebilirsiniz.

As can be seen from the following table, U-PVC pipes have very good strength against many chemicals and almost all acids. Strength information provided in the following table apply to a temperature of 20°C. U-PVC pipes may exhibit more different behaviors under higher temperatures. It is possible to obtain information about the strength status of U-PVC pipes against other chemicals and at higher temperatures from the company.

Kimyasalın Adı Name of Chemical	20°C'de Kullanım için Usage at 20°C	40°C'de Kullanım için Usage at 40°C
Anilin	Dayanısız (Irresistant) 😞	Dayanısız (Irresistant) 😞
Arsenic Asit (Up To %80 Conc.)	Dayanıklı (Resistant) 😊	Dayanıklı (Resistant) 😊
Aseton	Dayanısız (Irresistant) 😞	Dayanısız (Irresistant) 😞
Barium Salts (Saturated)	Dayanıklı (Resistant) 😊	Dayanıklı (Resistant) 😊
Beer (Commercial form)	Dayanıklı (Resistant) 😊	
Benzoic Acid	Dayanıklı (Resistant) 😊	Dayanıklı (Resistant) 😊
Gasoline (Fuel)	Dayanıklı (Resistant) 😊	Dayanıklı (Resistant) 😊
Borax (Ageous)	Dayanıklı (Resistant) 😊	Dayanıklı (Resistant) 😊
Boric Acid (Ageous)	Dayanıklı (Resistant) 😊	Dayanıklı (Resistant) 😊
Butanol	Dayanıklı (Resistant) 😊	Dayanıklı (Resistant) 😊
Calcium Hydroxide (Sturated)	Dayanıklı (Resistant) 😊	Dayanıklı (Resistant) 😊
Calcium Salts	Dayanıklı (Resistant) 😊	Dayanıklı (Resistant) 😊
Carbonic Acid	Dayanıklı (Resistant) 😊	Dayanıklı (Resistant) 😊
Caustic Soda (NaOH) (50% Conc.)	Dayanıklı (Resistant) 😊	Dayanıklı (Resistant) 😊
Citric Acid	Dayanıklı (Resistant) 😊	Dayanıklı (Resistant) 😊
Chloric Acid (Up To %20 Conc.)	Dayanıklı (Resistant) 😊	Dayanıklı (Resistant) 😊
Chlorine Gas	Dayanısız (Irresistant) 😞	
Chloroform	Dayanısız (Irresistant) 😞	
Compressed Air With Oil	Dayanısız (Irresistant) 😞	Dayanısız (Irresistant) 😞
Copper Salts	Dayanıklı (Resistant) 😊	Dayanıklı (Resistant) 😊
Diesel Feul (Commercial Form)	Dayanıklı (Resistant) 😊	Dayanıklı (Resistant) 😊
Ethyl Alcohol (%96 Conc.)	Dayanıklı (Resistant) 😊	Dayanıklı (Resistant) 😊
Formic Acid (Up To %50 Aqueous Conc.)	Dayanıklı (Resistant) 😊	Dayanıklı (Resistant) 😊
Freon 12 Gas	Dayanıklı (Resistant) 😊	
Fruit Juice	Dayanıklı (Resistant) 😊	Dayanıklı (Resistant) 😊
Fuel Oil	Dayanıklı (Resistant) 😊	Dayanıklı (Resistant) 😊
Glucose	Dayanıklı (Resistant) 😊	Dayanıklı (Resistant) 😊
Hexane	Dayanıklı (Resistant) 😊	Dayanıklı (Resistant) 😊
Hydrochloric Acid (Up To %38 Aqueous Conc.)	Dayanıklı (Resistant) 😊	Dayanıklı (Resistant) 😊

U-PVC BORULARIN ASİT DAYANIMLARI	
Medium	Up to 5 concentration
Sulphuric Acid	≤ 70 % H2SO4
Chromic-Sulphuric acid mixture Chromic Acid	≤ 70 % H2SO4 + K2Cr207 / Na2Cr201 ≤ 10 % CrO3
Hydrochloric Acid	≤ 25% HCl
Nidric Acid	≤ 20 % HNO3 ≤ 6 % HaOCl
Sodium hypochlorite (potassium hypochlorite)	
Hydrogen peroxide	≤ 5 % H2O2
Hydrofluoric Acid	≤ 0 % HF

Kimyasalın Adı Name of Chemical	20°C'de Kullanım için Usage at 20°C	40°C'de Kullanım için Usage at 40°C
Hydrogen Peroxide (Up To 90 % Conc.)	Dayanıklı (Resistant) 😊	
Lactic Acid (% 10 Aqueous Conc)	Dayanıklı (Resistant) 😊	Sınırlı Dayanıklı (Medum Resistant) 😞
Methane - Doğal Gaz (Natural Gas)	Dayanıklı (Resistant) 😊	
Methanol	Dayanıklı (Resistant) 😊	Dayanıklı (Resistant) 😊
Milk (Süt)	Dayanıklı (Resistant) 😊	Dayanıklı (Resistant) 😊
Mineral Water (Maden Suyu)	Dayanıklı (Resistant) 😊	Dayanıklı (Resistant) 😊
Naphtaline	Dayanısız (Irresistant) 😞	
Nitric Acid (HNO3) (% 6,3 Aqueous Conc.)	Dayanıklı (Resistant) 😊	Dayanıklı (Resistant) 😊
Nitric Acid (HNO3) (% 25 Aqueous Conc.)	Dayanıklı (Resistant) 😊	Dayanıklı (Resistant) 😊
Nitric Acid (HNO3) (% 65 Aqueous Conc.)	Sınırlı Dayanıklı (Medum Resistant) 😞	Sınırlı Dayanıklı (Medum Resistant) 😞
Nitric Acid (HNO3) (More Than % 85 Aqueous Conc.)	Dayanısız (Irresistant) 😞	
Olive Oil	Dayanıklı (Resistant) 😊	Dayanıklı (Resistant) 😊
Phosphoric Acid (Up To % 95 Aqueous Conc.)	Dayanıklı (Resistant) 😊	Dayanıklı (Resistant) 😊
Phthalic Acid (Saturated)	Dayanıklı (Resistant) 😊	Sınırlı Dayanıklı (Medum Resistant) 😞
Potassium Hydroxide (% 50 Aqueous Conc.)	Dayanıklı (Resistant) 😊	Dayanıklı (Resistant) 😊
Propane (Gaseous And Liquid)	Dayanıklı (Resistant) 😊	
Salisilic Acid (Saturated)	Dayanıklı (Resistant) 😊	Dayanıklı (Resistant) 😊
Sea Water	Dayanıklı (Resistant) 😊	Dayanıklı (Resistant) 😊
Starch (Nişasta) (Aqueous Solution)	Dayanıklı (Resistant) 😊	Dayanıklı (Resistant) 😊
Sulphuric Acid (Up To % 98 Aqueous Conc.)	Dayanıklı (Resistant) 😊	Dayanıklı (Resistant) 😊
Toluene	Dayanısız (Irresistant) 😞	
Urea (Up To % 30 Conc.)	Dayanıklı (Resistant) 😊	Dayanıklı (Resistant) 😊
Urine	Dayanıklı (Resistant) 😊	Dayanıklı (Resistant) 😊
Xylene	Dayanısız (Irresistant) 😞	

KISALTMALAR LİSTESİ
LIST OF ABBREVIATIONS

ANSI	American National Standard
ASTM	American Society for Testing and Materials
BS	British Standard
DIN	Deutsche Industrie-Normen
ISO	International Standardization Organisation
ABS	Acrylnitril Butadien Styrene
PVC-U	Polyvinyl Chloride
PVC- U	Polyvinyl Chloride chlorinated
PP	Plypropylene heat stabilised
PE	Polyethylene
PVDF	Polyvinylidene fluoride
EPDM	Ethylene Propylene Rubber
FPM	Fluorine Rubber. e.g. Viton
NBR	Nitrile Rubber
IIR	Butyl Rubber
CSM	Chlore Sulphonyl Polythene. e.g. Hypalon
CR	Chloroprene Rubber. e.g. Neoprene
PTFE	Polytetrafluorethylene. e.g. Teflon
PB TP	Polybutylene lerephthalate
UP-GF	Unsaturated colyester resin glassfiare reinforced
St	Steel
Ms	Brass
Tg	Malleable iron
d	Pipe outside diameter
DN	Nominal bore
PN	Nominal pressure at 20°C. water
kg	Weight in kilograms
SP	Standard pack. The figure given indicat the quantity of fittings contained in a gross
G	Pipe thread. not pressure tight in the thread to Iso 228-1
NPT	Taper male thread pressure tight in the thread to ANSI B 1.20.1
R	Taper male thread. pressure tight in the thread to ISO7-1/DIN 2999-1
Rc	Taper female thread. pressure tight in the thread to ISO 7-1/DIN 2999-1
Rp	Parallel female thread. pressure tight in the thread to ISO7-1/DIN 2999-1 Trapezoid thread
Tr	Trapezoid thread
SC	Size of hexagon bolts
s	A/F
e	Wall thickness
AL	Number of bolt hales
®	Registered trade-mark
①	Call for price

U-PVC BORULAR PIPES

ÜRETİM STANDARDI
PRODUCTION STANDARD | EN 1452-2

ÇAP / SIZE Ø20 - Ø400

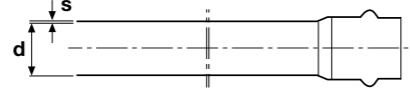

U-PVC Geçme Mufllu Borular
 Pipe With O-Ring (Gasket Socketed)

PN 4

Çap Dia	Basınç PN	Kod / Code 6 m	Fiyat (metre) Price (meter)	Ağırlık (Kg/m) Weight (Kg/m)	S(mm) Et kalınlığı Wall Thickness
Emniyet kat sayısı (safety factor) C =2,5					
75	4	101 04 075 1		0,65	1,8
90	4	101 04 090 1		0,79	1,8
Emniyet kat sayısı (safety factor) C =2,0					
110	4	101 04 110 1		1,16	2,2
125	4	101 04 125 1		1,50	2,5
140	4	101 04 140 1		1,88	2,8
160	4	101 04 160 1		2,43	3,2
200	4	101 04 200 1		3,80	4,0
225	4	101 04 225 3		4,81	4,5
250	4	101 04 250 3		5,82	4,9
280	4	101 04 280 3		7,32	5,5
315	4	101 04 315 3		9,27	6,2
355	4	101 04 355 3		11,8	7,0
400	4	101 04 400 3		15,1	7,9
450	4	101 04 450 3		20,6	8,9
500	4	101 04 500 3		24,0	9,8

PN 6

Çap Dia	Basınç PN	Kod / Code 6 m	Fiyat (metre) Price (meter)	Ağırlık (Kg/m) Unit Weight (Kg/m)	S(mm) Et kalınlığı Wall Thickness
Emniyet kat sayısı (safety factor) C =2,5					
50	6	101 06 050 1		0,36	1,6
63	6	101 06 063 1		0,57	2,0
75	6	101 06 075 1		0,79	2,3
90	6	101 06 090 1		1,15	2,8
Emniyet kat sayısı (safety factor) C =2,0					
110	6	101 06 110 1		1,43	2,7
125	6	101 06 125 1		1,86	3,1
140	6	101 06 140 1		2,36	3,5
160	6	101 06 160 1		3,08	4,0
200	6	101 06 200 1		4,72	4,9
225	6	101 06 225 3		5,97	5,5
250	6	101 06 250 3		7,48	6,2
280	6	101 06 280 3		9,31	6,9
315	6	101 06 315 3		11,7	7,7
355	6	101 06 355 3		14,9	8,7
400	6	101 06 400 3		19,0	9,8
450	6	101 06 450 3		24,15	11,0
500	6	101 06 500 3		30,0	12,3

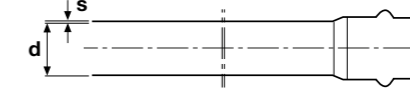
Fiyatlara conta dahil değildir. Gasket is not included the price
 Miktar yeterli olması durumunda özel boylarda üretim yapılabilir. If the quantity is sufficient, special lengths can be produced.

U-PVC Geçme Mufllu Borular
 Pipe With O-Ring (Gasket Socketed)

PN 10

Çap Dia	Basınç PN	Kod / Code 6 m	Fiyat (metre) Price (meter)	Ağırlık (Kg/m) Weight (Kg/m)	S(mm) Et kalınlığı Wall Thickness
Emniyet kat sayısı (safety factor) C =2,5					
50	10	101 10 050 1		0,56	2,4
63	10	101 10 063 1		0,87	3,0
75	10	101 10 075 1		1,25	3,6
90	10	101 10 090 1		1,80	4,3
Emniyet kat sayısı (safety factor) C =2,0					
110	10	101 10 110 1		2,19	4,2
125	10	101 10 125 1		2,82	4,8
140	10	101 10 140 1		3,57	5,4
160	10	101 10 160 1		4,69	6,2
200	10	101 10 200 1		7,27	7,7
225	10	101 10 225 3		9,15	8,6
250	10	101 10 250 3		11,3	9,6
280	10	101 10 280 3		14,3	10,7
315	10	101 10 315 3		18,1	12,1
355	10	101 10 355 3		22,9	13,6
400	10	101 10 400 3		29,3	15,3
450	10	101 10 450 3		32,0	17,2
500	10	101 10 500 3			19,1

PN 16

Çap Dia	Basınç PN	Kod / Code 6 m	Fiyat (metre) Price (meter)	Ağırlık (Kg/m) Unit Weight (Kg/m)	S(mm) Et kalınlığı Wall Thickness
Emniyet kat sayısı (safety factor) C =2,5					
50	16	101 16 050 1		0,82	3,7
63	16	101 16 063 1		1,31	4,7
75	16	101 16 075 1		1,88	5,6
90	16	101 16 090 1		2,69	6,7
Emniyet kat sayısı (safety factor) C =2,0					
110	16	101 16 110 1		3,31	6,6
125	16	101 16 125 1		4,23	7,4
140	16	101 16 140 1		5,33	8,3
160	16	101 16 160 1		6,96	9,5
200	16	101 16 200 1		10,9	11,9
225	16	101 16 225 3		13,8	13,4
250	16	101 16 250 3		17,0	14,8
280	16	101 16 280 3		21,4	16,6
315	16	101 16 315 3		27,2	18,7
355	16	101 16 355 3		34,6	21,1
400	16	101 16 400 3		44,6	23,7
450	16	101 16 450 3			
500	16	101 16 500 3			

Fiyatlara conta dahil değildir. Gasket is not included the price
 Miktar yeterli olması durumunda özel boylarda üretim yapılabilir. If the quantity is sufficient, special lengths can be produced.

U-PVC Yapıştırma Mufllu Borular

U-PVC Solvent Cement Socketed Pressure Pipes

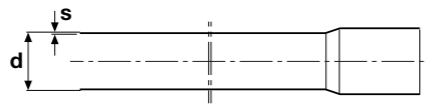
PN 4

Çap Dia	Basınç PN	Kod / Code 6 m	Kod / Code 3 m	Fiyat (metre) Price (meter)	Ağırlık (Kg/m) Weight (Kg/m)	S(mm) Et kalınlığı Wall Thickness
Emniyet kat sayısı (safety factor) C =2,5						
75	4	100 04 075 1	150 04 075 1		0,65	1,8
90	4	100 04 090 1	150 04 090 1		0,79	1,8
Emniyet kat sayısı (safety factor) C =2,0						
110	4	100 04 110 1	150 04 110 1		1,16	2,2
125	4	100 04 125 1	150 04 125 1		1,5	2,5
140	4	100 04 140 1	150 04 140 1		1,88	2,8
160	4	100 04 160 1	150 04 160 1		2,43	3,2
200	4	100 04 200 1	150 04 200 1		3,80	4,0
225	4	100 04 225 3	150 04 225 3		4,81	4,5
250	4	100 04 250 3	150 04 250 3		5,82	4,9
280	4	100 04 280 3	150 04 280 3		7,32	5,5
315	4	100 04 315 3	150 04 315 3		9,27	6,2
355	4	100 04 355 3	150 04 355 3		11,8	7,0
400	4	100 04 400 3	150 04 400 3		15,6	7,9
450	4	100 04 450 3	150 04 450 3		20,9	8,9
500	4	100 04 500 3	150 04 500 3		24,1	9,8

PN 6

Çap Dia	Basınç PN	Kod / Code 6 m	Kod / Code 3 m	Fiyat (metre) Price (meter)	Ağırlık (Kg/m) Weight (Kg/m)	S(mm) Et kalınlığı Wall Thickness
Emniyet kat sayısı (safety factor) C =2,5						
50	6	100 06 050 1	150 06 050 1		0,36	1,6
63	6	100 06 063 1	150 06 063 1		0,57	2,0
75	6	100 06 075 1	150 06 075 1		0,79	2,3
90	6	100 06 090 1	150 06 090 1		1,15	2,8
Emniyet kat sayısı (safety factor) C =2,0						
110	6	100 06 110 1	150 06 110 1		1,37	2,7
125	6	100 06 125 1	150 06 125 1		1,78	3,1
140	6	100 06 140 1	150 06 140 1		2,21	3,5
160	6	100 06 160 1	150 06 160 1		2,88	4,0
200	6	100 06 200 1	150 06 200 1		4,46	4,9
225	6	100 06 225 3	150 06 225 3		5,67	5,5
250	6	100 06 250 3	150 06 250 3		6,98	6,2
280	6	100 06 280 3	150 06 280 3		8,76	6,9
315	6	100 06 315 3	150 06 315 3		11,08	7,7
355	6	100 06 355 3	150 06 355 3		14,18	8,7
400	6	100 06 400 3	150 06 400 3		17,94	9,8
450	6	100 06 450 3	150 06 450 3		23,11	11,0
500	6	100 06 500 3	150 06 500 3		28,72	12,3

Miktar yeterli olması durumunda özel boylarda üretim yapılabilir. If the quantity is sufficient, special lengths can be produced.

U-PVC Yapıştırma Mufllu Borular

U-PVC Solvent Cement Socketed Pressure Pipes

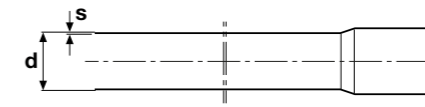

PN 10

Çap Dia	Basınç PN	Kod / Code 6 m	Kod / Code 3 m	Fiyat (metre) Price (meter)	Ağırlık (Kg/m) Weight (Kg/m)	S(mm) Et kalınlığı Wall Thickness
Emniyet kat sayısı (safety factor) C =2,5						
25	10	100 10 025 1	150 10 025 1		0,16	1,5
32	10	100 10 032 1	150 10 032 1		0,24	1,6
40	10	100 10 040 1	150 10 040 1		0,35	1,9
50	10	100 10 050 1	150 10 050 1		0,56	2,4
63	10	100 10 063 1	150 10 063 1		0,87	3,0
75	10	100 10 075 1	150 10 075 1		1,24	3,6
90	10	100 10 090 1	150 10 090 1		1,78	4,3
Emniyet kat sayısı (safety factor) C =2,0						
110	10	100 10 110 1	150 10 110 1		2,16	4,2
125	10	100 10 125 1	150 10 125 1		2,78	4,8
140	10	100 10 140 1	150 10 140 1		3,51	5,4
160	10	100 10 160 1	150 10 160 1		4,60	6,2
200	10	100 10 200 1	150 10 200 1		7,12	7,7
225	10	100 10 225 3	150 10 225 3		8,95	8,6
250	10	100 10 250 3	150 10 250 3		11,1	9,6
280	10	100 10 280 3	150 10 280 3		14,0	10,7
315	10	100 10 315 3	150 10 315 3		17,4	12,1
355	10	100 10 355 3	150 10 355 3		22,1	13,6
400	10	100 10 400 3	150 10 400 3		28,0	15,3
450	10	100 10 450 3	150 10 450 3		35,6	17,2
500	10	100 10 500 3	150 10 500 3		43,9	19,1

PN 16

Çap Dia	Basınç PN	Kod / Code 6 m	Kod / Code 3 m	Fiyat (metre) Price (meter)	Ağırlık (Kg/m) Weight (Kg/m)	S(mm) Et kalınlığı Wall Thickness
Emniyet kat sayısı (safety factor) C =2,5						
20	16	100 16 020 1	150 16 020 1		0,13	1,5
25	16	100 16 025 1	150 16 025 1		0,21	1,9
32	16	100 16 032 1	150 16 032 1		0,34	2,4
40	16	100 16 040 1	150 16 040 1		0,53	3,0
50	16	100 16 050 1	150 16 050 1		0,82	3,7
63	16	100 16 063 1	150 16 063 1		1,31	4,7
75	16	100 16 075 1	150 16 075 1		1,86	5,6
90	16	100 16 090 1	150 16 090 1		2,66	6,7
Emniyet kat sayısı (safety factor) C =2,0						
110	16	100 16 110 1	150 16 110 1		3,26	6,6
125	16	100 16 125 1	150 16 125 1		4,16	7,4
140	16	100 16 140 1	150 16 140 1		5,23	8,3
160	16	100 16 160 1	150 16 160 1		6,83	9,5
200	16	100 16 200 1	150 16 200 1		10,61	11,9
225	16	100 16 225 3	150 16 225 3		13,4	13,4
250	16	100 16 250 3	150 16 250 3		16,5	14,8
280	16	100 16 280 3	150 16 280 3		20,4	16,6
315	16	100 16 315 3	150 16 315 3		26,8	18,7
355	16	100 16 355 3	150 16 355 3		33,6	21,1
400	16	100 16 400 3	150 16 400 3		42,8	23,7
450	16	100 16 450 3	150 16 450 3			
500	16	100 16 500 3	150 16 500 3			

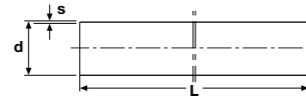
Miktar yeterli olması durumunda özel boylarda üretim yapılabilir. If the quantity is sufficient, special lengths can be produced.

U-PVC Zonder Boru
 U-PVC Industry Pipes

PN 20

Çap Dia	Basınç PN	Kod /Code 3 m	Fiyat (metre) Price (meter)	Birim ağırlık (Kg/m) Unit Weight (Kg/m)	S (mm) Et kalınlığı Wall Thickness
Emniyet kat sayısı (safety factor) C =2,5					
20	20	102 20 020 1		0,17	1,9
25	20	102 20 025 1		0,27	2,3
32	20	102 20 032 1		0,41	2,9
40	20	102 20 040 1		0,65	3,7
50	20	102 20 050 1		1,00	4,6
63	20	102 20 063 1		1,59	5,8
75	20	102 20 075 1		2,21	6,8
90	20	102 20 090 1		3,20	8,2
Emniyet kat sayısı (safety factor) C =2,0					
110	20	102 20 110 1		3,99	8,1
125	20	102 20 125 1		5,10	8,7
140	20	102 20 140 1		6,38	9,2
160	20	102 20 160 1		7,34	11,8
200	20	102 20 200 1		13,0	14,7

PN 25

Çap Dia	Basınç PN	Kod /Code 3 m	Fiyat (metre) Price (meter)	Birim ağırlık (Kg/m) Unit Weight (Kg/m)	S(mm) Et kalınlığı Wall Thickness
Emniyet kat sayısı (safety factor) C =2,5					
20	25	102 25 020 1		0,19	2,3
25	25	102 25 025 1		0,29	2,8
32	25	102 25 032 1		0,49	3,6
40	25	102 25 040 1		0,81	4,5
50	25	102 25 050 1		1,19	5,6
63	25	102 25 063 1		1,9	7,1
75	25	102 25 075 1		2,67	8,4
90	25	102 25 090 1		3,83	10,0
Emniyet kat sayısı (safety factor) C =2,0					
110	25	102 25 110 1		4,78	10,0
125	25	102 25 125 1		6,2	11,4
140	25	102 25 140 1		7,68	12,6
160	25	102 25 160 1		10,1	14,6
200	25	102 25 200 1		15,7	18,2

U-PVC Şeffaf Boru
 U-PVC Transparent Pipe

Çap Dia	Basınç PN	Kod / Code 5 m	Fiyat (metre) Price (meter)	(Kg/m) (Kg/m)	S (mm) Et kalınlığı Wall Thickness
20	10	231 020 0208		0,13	1,5
25	10	231 020 0258		0,17	1,5
32	10	231 020 0328		0,26	1,8
40	10	231 020 0408		0,36	2,0
50	10	231 020 0508		0,55	2,4
63	10	231 020 0638		0,85	3,0
75	10	231 020 0758		1,22	3,6
90	10	231 020 0908		1,75	4,3
110	10	231 020 1108		2,61	5,3
125	10	231 020 1258		-	-
140	10	231 020 1408		-	-
160	10	231 020 1608		-	-
200	10	231 020 2008		-	-

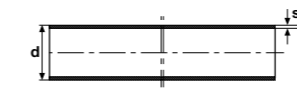
U-PVC Özel Amaçlı Borular
 U-PVC Specific Usage Pipes

Çap Dia	Kod / Code 3 m	Fiyat (metre) Price (meter)	(Kg/m) (Kg/m)	S (mm) Et kalınlığı Wall Thickness
8	121 15 008 1		0,04	1,5
9	121 15 009 1		0,05	1,5
10	121 15 010 1		0,06	1,5
10	121 20 010 1		0,04	1,0
11	121 15 011 1		0,06	1,5
12	121 15 012 1		0,07	1,5
12	121 20 012 1		0,09	2,0
14	121 20 014 1		0,11	2,0
16	121 20 016 1		0,13	2,0
17	121 10 017 1		0,07	1,0
17	121 15 017 1		0,11	1,5
18	121 15 018 1		0,11	1,5
20	121 10 020 1		0,09	1,0
20	121 15 020 1		0,13	1,5
20	121 20 020 1		0,17	2,0
21	121 20 021 1		0,18	2,0
22	121 25 022 1		0,23	2,5
23	121 10 023 1		0,10	1,0
27	121 20 027 1		0,23	2,0
32	121 15 032 1		0,21	1,5
33	121 20 033 1		0,29	2,0
40	121 20 040 1		0,36	2,0
42	121 20 042 1		0,38	2,0
50	121 20 050 1		0,46	2,0
63	121 20 063 1		0,58	2,0

Not / Note

U-PVC

DEVE BOYNU BORULAR

LONG BEND PIPES

ÜRETİM STANDARDI
PRODUCTION STANDARD | EN 1452-2

ÇAP / SIZE Ø25 - Ø500

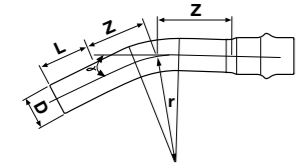

U-PVC Geçme Muflu Temiz Su Deve Boynu
 U-PVC Long Bend With O-Ring Socketed

11° PN 10

Çap Dia	Basınç PN	Kod Code	Fiyat (Adet) Price (Pcs)	Açı Angle	Yarıçap R	Z mm	L mm
Emniyet kat sayısı (safety factor) C =2,5							
50	10	111 10 050 6		11°	125	62	86
63	10	111 10 063 6		11°	221	46	90
75	10	111 10 075 6		11°	263	55	94
90	10	111 10 090 6		11°	315	66	97
Emniyet kat sayısı (safety factor) C =2,0							
110	10	111 10 110 6		11°	385	81	104
125	10	111 10 125 6		11°	438	92	108
140	10	111 10 140 6		11°	490	103	112
160	10	111 10 160 6		11°	560	118	119
200	10	111 10 200 6		11°	700	147	129
225	10	111 10 225 6		11°	788	166	136
250	10	111 10 250 6		11°	875	184	143
280	10	111 10 280 6		11°	980	206	152
315	10	111 10 315 6		11°	1103	232	160
355	10	111 10 355 6		11°	1243	262	169
400	10	111 10 400 6		11°	1400	295	178
450	10	111 10 450 6		11°	1575	332	
500	10	111 10 500 6		11°	1750	369	

U-PVC Geçme Muflu Temiz Su Deve Boynu
 U-PVC Long Bend With O-Ring Socketed

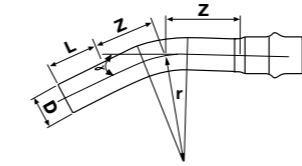
22,5° PN 10

Çap Dia	Basınç PN	Kod Code	Fiyat (Adet) Price (Pcs)	Açı Angle	Yarıçap R	Z mm	L mm
Emniyet kat sayısı (safety factor) C =2,5							
50	10	112 10 050 6		22,5°	125	74	86
63	10	112 10 063 6		22,5°	221	68	90
75	10	112 10 075 6		22,5°	263	81	94
90	10	112 10 090 6		22,5°	315	97	97
Emniyet kat sayısı (safety factor) C =2,0							
110	10	112 10 110 6		22,5°	385	119	104
125	10	112 10 125 6		22,5°	438	135	108
140	10	112 10 140 6		22,5°	490	151	112
160	10	112 10 160 6		22,5°	560	173	119
200	10	112 10 200 6		22,5°	700	216	129
225	10	112 10 225 6		22,5°	788	243	136
250	10	112 10 250 6		22,5°	875	270	143
280	10	112 10 280 6		22,5°	980	302	152
315	10	112 10 315 6		22,5°	1103	340	160
355	10	112 10 355 6		22,5°	1243	384	169
400	10	112 10 400 6		22,5°	1400	432	178
450	10	112 10 450 6		22,5°	1575	486	
500	10	112 10 500 6		22,5°	1750	540	

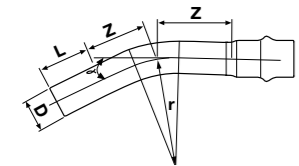
11° PN 16

Çap Dia	Basınç PN	Kod Code	Fiyat (Adet) Price (Pcs)	Açı Angle	Yarıçap R	Z mm	L mm
Emniyet kat sayısı (safety factor) C =2,5							
50	16	111 16 050 6		11°	125	62	86
63	16	111 16 063 6		11°	221	46	90
75	16	111 16 075 6		11°	263	55	94
90	16	111 16 090 6		11°	315	66	97
Emniyet kat sayısı (safety factor) C =2,0							
110	16	111 16 110 6		11°	385	81	104
125	16	111 16 125 6		11°	438	92	108
140	16	111 16 140 6		11°	490	103	112
160	16	111 16 160 6		11°	560	118	119
200	16	111 16 200 6		11°	700	147	129
225	16	111 16 225 6		11°	788	166	136
250	16	111 16 250 6		11°	875	184	143
280	16	111 16 280 6		11°	980	206	152
315	16	111 16 315 6		11°	1103	232	160
355	16	111 16 355 6		11°	1243	262	169
400	16	111 16 400 6		11°	1400	295	178
450	16	111 16 450 6		11°	1575	332	
500	16	111 16 500 6		11°	1750	369	

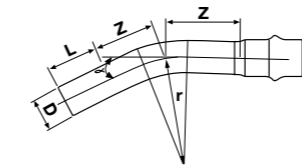
22,5° PN 16

Çap Dia	Basınç PN	Kod Code	Fiyat (Adet) Price (Pcs)	Açı Angle	Yarıçap R	Z mm	L mm
Emniyet kat sayısı (safety factor) C =2,5							
50	16	112 16 050 6		22,5°	125	74	86
63	16	112 16 063 6		22,5°	221	68	90
75	16	112 16 075 6		22,5°	263	81	94
90	16	112 16 090 6		22,5°	315	97	97
Emniyet kat sayısı (safety factor) C =2,0							
110	16	112 16 110 6		22,5°	385	119	104
125	16	112 16 125 6		22,5°	438	135	108
140	16	112 16 140 6		22,5°	490	151	112
160	16	112 16 160 6		22,5°	560	173	119
200	16	112 16 200 6		22,5°	700	216	129
225	16	112 16 225 6		22,5°	788	243	136
250	16	112 16 250 6		22,5°	875	270	143
280	16	112 16 280 6		22,5°	980	302	152
315	16	112 16 315 6		22,5°	1103	340	160
355	16	112 16 355 6		22,5°	1243	384	169
400	16	112 16 400 6		22,5°	1400	432	178
450	16	112 16 450 6		22,5°	1575	486	
500	16	112 16 500 6		22,5°	1750	540	

U-PVC Geçme Muflu Temiz Su Deve Boynu
U-PVC Long Bend With O-Ring Socketed

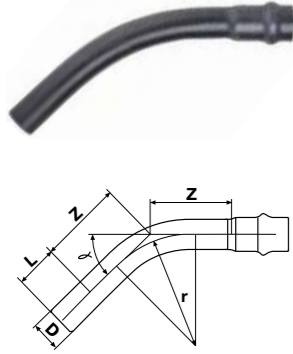
30° PN 10

Çap Dia	Basınç PN	Kod Code	Fiyat (Adet) Price (Pcs)	Açı Angle	Yarıçap R	Z mm	L mm
Emniyet kat sayısı (safety factor) C =2,5							
50	10	113 10 050 6		30°	125	84	86
63	10	112 10 063 6		30°	221	84	90
75	10	113 10 075 6		30°	263	100	94
90	10	113 10 090 6		30°	315	120	97
Emniyet kat sayısı (safety factor) C =2,0							
110	10	113 10 110 6		30°	385	147	104
125	10	113 10 125 6		30°	438	167	108
140	10	113 10 140 6		30°	490	187	112
160	10	113 10 160 6		30°	560	214	119
200	10	113 10 200 6		30°	700	268	129
225	10	113 10 225 6		30°	788	301	136
250	10	113 10 250 6		30°	875	334	143
280	10	113 10 280 6		30°	980	375	152
315	10	113 10 315 6		30°	1103	421	160
355	10	113 10 355 6		30°	1243	475	169
400	10	113 10 400 6		30°	1400	535	178
450	10	113 10 450 6		30°	1575	602	
500	10	113 10 500 6		30°	1750	669	

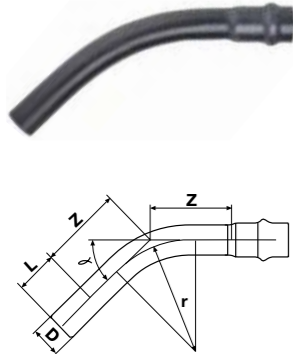
30° PN 16

Çap Dia	Basınç PN	Kod Code	Fiyat (Adet) Price (Pcs)	Açı Angle	Yarıçap R	Z mm	L mm
Emniyet kat sayısı (safety factor) C =2,5							
50	16	113 16 050 6		30°	125	84	86
63	16	113 16 063 6		30°	221	84	90
75	16	113 16 075 6		30°	263	100	94
90	16	113 16 090 6		30°	315	120	97
Emniyet kat sayısı (safety factor) C =2,0							
110	16	113 16 110 6		30°	385	147	104
125	16	113 16 125 6		30°	438	167	108
140	16	113 16 140 6		30°	490	187	112
160	16	113 16 160 6		30°	560	214	119
200	16	113 16 200 6		30°	700	268	129
225	16	113 16 225 6		30°	788	301	136
250	16	113 16 250 6		30°	875	334	143
280	16	113 16 280 6		30°	980	375	152
315	16	113 16 315 6		30°	1103	421	160
355	16	113 16 355 6		30°	1243	475	169
400	16	113 16 400 6		30°	1400	535	178
450	16	113 16 450 6		30°	1575	602	
500	16	113 16 500 6		30°	1750	669	

Fiyatlara conta dahil değildir. Gasket is not included the price

U-PVC Geçme Muflu Temiz Su Deve Boynu
U-PVC Long Bend With O-Ring Socketed

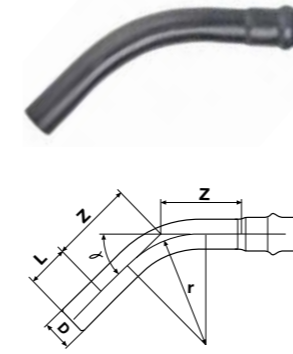
45° PN 10

Çap Dia	Basınç PN	Kod Code	Fiyat (Adet) Price (Pcs)	Açı Angle	Yarıçap R	Z mm	L mm
Emniyet kat sayısı (safety factor) C =2,5							
50	10	114 10 050 6		45°	125	102	86
63	10	114 10 063 6		45°	221	117	90
75	10	114 10 075 6		45°	263	139	94
90	10	114 10 090 6		45°	315	166	97
Emniyet kat sayısı (safety factor) C =2,0							
110	10	114 10 110 6		45°	385	203	104
125	10	114 10 125 6		45°	438	231	108
140	10	114 10 140 6		45°	490	259	112
160	10	114 10 160 6		45°	560	296	119
200	10	114 10 200 6		45°	700	370	129
225	10	114 10 225 6		45°	788	416	136
250	10	114 10 250 6		45°	875	462	143
280	10	114 10 280 6		45°	980	518	152
315	10	114 10 315 6		45°	1103	583	160
355	10	114 10 355 6		45°	1243	656	169
400	10	114 10 400 6		45°	1400	740	178
450	10	114 10 450 6		45°	1575	832	
500	10	114 10 500 6		45°	1750	925	

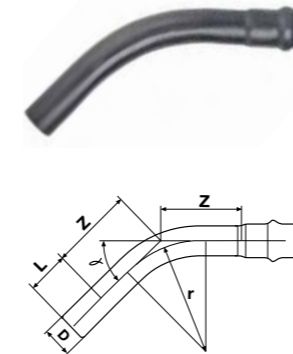
45° PN 16

Çap Dia	Basınç PN	Kod Code	Fiyat (Adet) Price (Pcs)	Açı Angle	Yarıçap R	Z mm	L mm
Emniyet kat sayısı (safety factor) C =2,5							
50	16	114 16 050 6		45°	125	84	86
63	16	114 16 063 6		45°	221	84	90
75	16	114 16 075 6		45°	263	100	94
90	16	114 16 090 6		45°	315	120	97
Emniyet kat sayısı (safety factor) C =2,0							
110	16	114 16 110 6		45°	385	147	104
125	16	114 16 125 6		45°	438	167	108
140	16	114 16 140 6		45°	490	187	112
160	16	114 16 160 6		45°	560	214	119
200	16	114 16 200 6		45°	700	268	129
225	16	114 16 225 6		45°	788	301	136
250	16	114 16 250 6		45°	875	334	143
280	16	114 16 280 6		45°	980	375	152
315	16	114 16 315 6		45°	1103	421	160
355	16	114 16 355 6		45°	1243	475	169
400	16	114 16 400 6		45°	1400	535	178
450	16	114 16 450 6		45°	1575	602	
500	16	114 16 500 6		45°	1750	669	

Fiyatlara conta dahil değildir. Gasket is not included the price

U-PVC Geçme Mufllu Temiz Su Deve Boynu
 U-PVC Long Bend With O-Ring Socketed

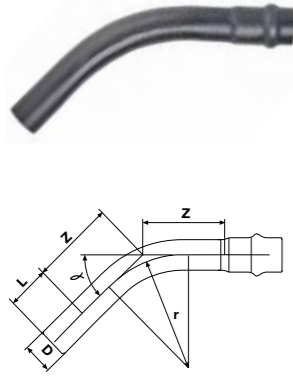
60° PN 10

Çap Dia	Basınç PN	Kod Code	Fiyat (Adet) Price (Pcs)	Açı Angle	Yarıçap R	Z mm	L mm
Emniyet kat sayısı (safety factor) C =2,5							
50	10	115 10 050 6		60°	125	122	86
63	10	115 10 063 6		60°	221	153	90
75	10	115 10 075 6		60°	263	182	94
90	10	115 10 090 6		60°	315	218	97
Emniyet kat sayısı (safety factor) C =2,0							
110	10	115 10 110 6		60°	385	266	104
125	10	115 10 125 6		60°	438	303	108
140	10	115 10 140 6		60°	490	339	112
160	10	115 10 160 6		60°	560	387	119
200	10	115 10 200 6		60°	700	484	129
225	10	115 10 225 6		60°	788	545	136
250	10	115 10 250 6		60°	875	605	143
280	10	115 10 280 6		60°	980	678	152
315	10	115 10 315 6		60°	1103	763	160
355	10	115 10 355 6		60°	1243	859	169
400	10	115 10 400 6		60°	1400	968	178
450	10	115 10 450 6		60°	1575	1089	
500	10	115 10 500 6		60°	1750	1210	

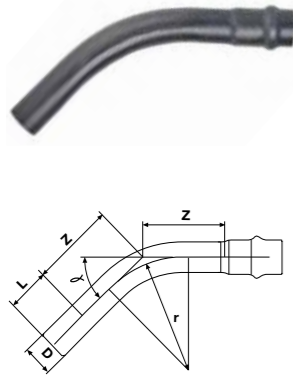
60° PN 16

Çap Dia	Basınç PN	Kod Code	Fiyat (Adet) Price (Pcs)	Açı Angle	Yarıçap R	Z mm	L mm
Emniyet kat sayısı (safety factor) C =2,5							
50	16	115 16 050 6		60°	125	122	86
63	16	115 16 063 6		60°	221	153	90
75	16	115 16 075 6		60°	263	182	94
90	16	115 16 090 6		60°	315	218	97
Emniyet kat sayısı (safety factor) C =2,0							
110	16	115 16 110 6		60°	385	266	104
125	16	115 16 125 6		60°	438	303	108
140	16	115 16 140 6		60°	490	339	112
160	16	115 16 160 6		60°	560	387	119
200	16	115 16 200 6		60°	700	484	129
225	16	115 16 225 6		60°	788	545	136
250	16	115 16 250 6		60°	875	605	143
280	16	115 16 280 6		60°	980	678	152
315	16	115 16 315 6		60°	1103	763	160
355	16	115 16 355 6		60°	1243	859	169
400	16	115 16 400 6		60°	1400	968	178
450	16	115 16 450 6		60°	1575	1089	
500	16	115 16 500 6		60°	1750	1210	

Fiyatlara conta dahil değildir. Gasket is not included the price

U-PVC Geçme Mufllu Temiz Su Deve Boynu
 U-PVC Long Bend With O-Ring Socketed

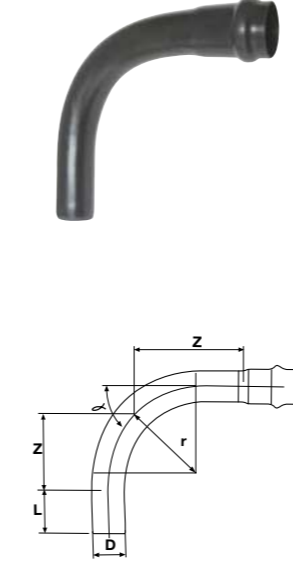
90° PN 10

Çap Dia	Basınç PN	Kod Code	Fiyat (Adet) Price (Pcs)	Açı Angle	Yarıçap R	Z mm	L mm
Emniyet kat sayısı (safety factor) C =2,5							
50	10	116 10 050 6		90°	125	175	86
63	10	116 10 063 6		90°	221	246	90
75	10	116 10 075 6		90°	263	293	94
90	10	116 10 090 6		90°	315	351	97
Emniyet kat sayısı (safety factor) C =2,0							
110	10	116 10 110 6		90°	385	429	104
125	10	116 10 125 6		90°	438	488	108
140	10	116 10 140 6		90°	490	546	112
160	10	116 10 160 6		90°	560	624	119
200	10	116 10 200 6		90°	700	780	129
225	10	116 10 225 6		90°	788	878	136
250	10	116 10 250 6		90°	875	975	143
280	10	116 10 280 6		90°	980	1092	152
315	10	116 10 315 6		90°	1103	1229	160
355	10	116 10 355 6		90°	1243	1385	169
400	10	116 10 400 6		90°	1400	1560	178
450	10	116 10 450 6		90°	1575	1755	
500	10	116 10 500 6		90°	1750	1950	

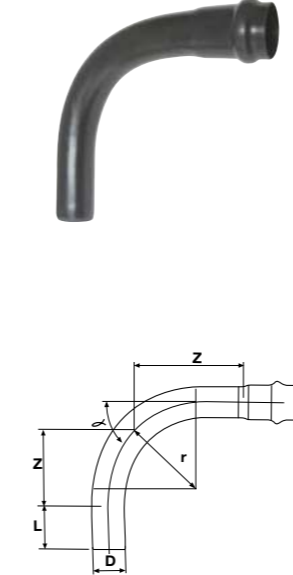
90° PN 16

Çap Dia	Basınç PN	Kod Code	Fiyat (Adet) Price (Pcs)	Açı Angle	Yarıçap R	Z mm	L mm
Emniyet kat sayısı (safety factor) C =2,5							
50	16	116 16 050 6		90°	125	122	175
63	16	116 16 063 6		90°	221	153	246
75	16	116 16 075 6		90°	263	182	293
90	16	116 16 090 6		90°	315	218	351
Emniyet kat sayısı (safety factor) C =2,0							
110	16	116 16 110 6		90°	385	266	429
125	16	116 16 125 6		90°	438	303	488
140	16	116 16 140 6		90°	490	339	546
160	16	116 16 160 6		90°	560	387	624
200	16	116 16 200 6		90°	700	484	780
225	16	116 16 225 6		90°	788	545	878
250	16	116 16 250 6		90°	875	605	975
280	16	116 16 280 6		90°	980	678	1092
315	16	116 16 315 6		90°	1103	763	1229
355	16	116 16 355 6		90°	1243	859	1385
400	16	116 16 400 6		90°	1400	968	1560
450	16	116 16 450 6		90°	1575	1089	1755
500	16	116 16 500 6		90°	1750	1210	1950

Fiyatlara conta dahil değildir. Gasket is not included the price

U-PVC Yapıştırma Mufllu Temiz Su Deve Boynu
U-PVC Solvent Cement Socketed Long Bend

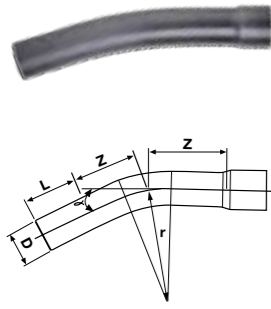
11° PN 10

Çap Dia	Basınç (PN)	Kod Code	Fiyat (Adet) Price (Pcs)	Açrı Angle	Yarıçap (r)	Z (mm)	L (mm)
Emniyet kat sayısı (safety factor) C =2,5							
25	10	105 10 025 6		11°	63	31	18,5
32	10	105 10 032 6		11°	80	40	22
40	10	105 10 040 6		11°	100	50	26
50	10	105 10 050 6		11°	125	62	31
63	10	105 10 063 6		11°	221	46	37,5
75	10	105 10 075 6		11°	263	55	43,5
90	10	105 10 090 6		11°	315	66	51
Emniyet kat sayısı (safety factor) C =2,0							
110	10	105 10 110 6		11°	385	81	61
125	10	105 10 125 6		11°	438	92	68,5
140	10	105 10 140 6		11°	490	103	76
160	10	105 10 160 6		11°	560	118	86
200	10	105 10 200 6		11°	700	147	106
225	10	105 10 225 6		11°	788	166	118,5
250	10	105 10 250 6		11°	875	184	131
280	10	105 10 280 6		11°	980	206	146
315	10	105 10 315 6		11°	1103	232	163,5
355	10	105 10 355 6		11°	1243	262	183,5
400	10	105 10 400 6		11°	1400	295	206
450	10	105 10 450 6		11°	1575	332	
500	10	105 10 500 6					

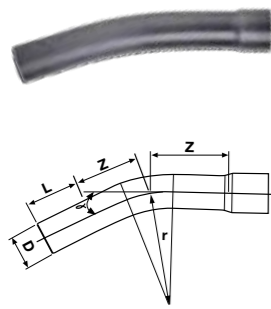
11° PN 16

Çap Dia	Basınç PN	Kod Code	Fiyat (Adet) Price (Pcs)	Açrı Angle	Yarıçap R	Z mm	L mm
Emniyet kat sayısı (safety factor) C =2,5							
25	16	105 16 025 6		11°	63	31	18,5
32	16	105 16 032 6		11°	80	40	22
40	16	105 16 040 6		11°	100	50	26
50	16	105 16 050 6		11°	125	62	31
63	16	105 16 063 6		11°	221	46	37,5
75	16	105 16 075 6		11°	263	55	43,5
90	16	105 16 090 6		11°	315	66	51
Emniyet kat sayısı (safety factor) C =2,0							
110	16	105 16 110 6		11°	385	81	61
125	16	105 16 125 6		11°	438	92	68,5
140	16	105 16 140 6		11°	490	103	76
160	16	105 16 160 6		11°	560	118	86
200	16	105 16 200 6		11°	700	147	106
225	16	105 16 225 6		11°	788	166	118,5
250	16	105 16 250 6		11°	875	184	131
280	16	105 16 280 6		11°	980	206	146
315	16	105 16 315 6		11°	1103	232	163,5
355	16	105 16 355 6		11°	1243	262	183,5
400	16	105 16 400 6		11°	1400	295	206
450	16	105 16 450 6		11°	1575	332	
500	16	105 16 500 6		11°	1750	369	

U-PVC Yapıştırma Mufllu Temiz Su Deve Boynu
U-PVC Solvent Cement Socketed Long Bend

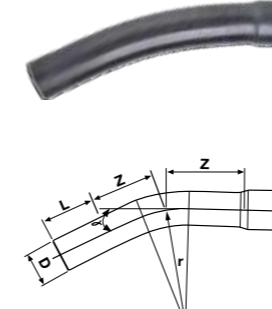
22,5° PN 10

Çap Dia	Basınç PN	Kod Code	Fiyat (Adet) Price (Pcs)	Açrı Angle	Yarıçap R	Z mm	L mm
Emniyet kat sayısı (safety factor) C =2,5							
25	10	106 10 025 6		22,5°	63	37	18,5
32	10	106 10 032 6		22,5°	80	48	22
40	10	106 10 040 6		22,5°	100	59	26
50	10	106 10 050 6		22,5°	125	74	31
63	10	106 10 063 6		22,5°	221	68	37,5
75	10	106 10 075 6		22,5°	263	81	43,5
90	10	106 10 090 6		22,5°	315	97	51
Emniyet kat sayısı (safety factor) C =2,0							
110	10	106 10 110 6		22,5°	385	119	61
125	10	106 10 125 6		22,5°	438	135	68,5
140	10	106 10 140 6		22,5°	490	151	76
160	10	106 10 160 6		22,5°	560	173	86
200	10	106 10 200 6		22,5°	700	216	106
225	10	106 10 225 6		22,5°	788	243	118,5
250	10	106 10 250 6		22,5°	875	270	131
280	10	106 10 280 6		22,5°	980	302	146
315	10	106 10 315 6		22,5°	1103	340	163,5
355	10	106 10 355 6		22,5°	1243	384	183,5
400	10	106 10 400 6		22,5°	1400	432	206
450	10	106 10 450 6		22,5°	1575	486	
500	10	106 10 500 6		22,5°	1750	540	

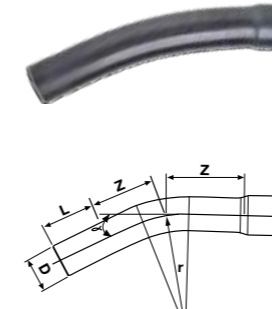
22,5° PN 16

Çap Dia	Basınç PN	Kod Code	Fiyat (Adet) Price (Pcs)	Açrı Angle	Yarıçap R	Z mm	L mm
Emniyet kat sayısı (safety factor) C =2,5							
25	16	106 16 025 6		22,5°	63	37	18,5
32	16	106 16 032 6		22,5°	80	48	22
40	16	106 16 040 6		22,5°	100	59	26
50	16	106 16 050 6		22,5°	125	74	31
63	16	106 16 063 6		22,5°	221	68	37,5
75	16	106 16 075 6		22,5°	263	81	43,5
90	16	106 16 090 6		22,5°	315	97	51
Emniyet kat sayısı (safety factor) C =2,0							
110	16	106 16 110 6		22,5°	385	119	61
125	16	106 16 125 6		22,5°	438	135	68,5
140	16	106 16 140 6		22,5°	490	151	76
160	16	106 16 160 6		22,5°	560	173	86
200	16	106 16 200 6		22,5°	700	216	106
225	16	106 16 225 6		22,5°	788	243	118,5
250	16	106 16 250 6		22,5°	875	270	131
280	16	106 16 280 6		22,5°	980	302	146
315	16	106 16 315 6		22,5°	1103	340	163,5
355	16	106 16 355 6		22,5°	1243	384	183,5
400	16	106 16 400 6		22,5°	1400	432	206
450	16	106 16 450 6		22,5°	1575	486	
500	16	106 16 500 6		22,5°	1750	540	

U-PVC Yapıştırma Mufllu Temiz Su Deve Boynu
 U-PVC Solvent Cement Socketed Long Bend

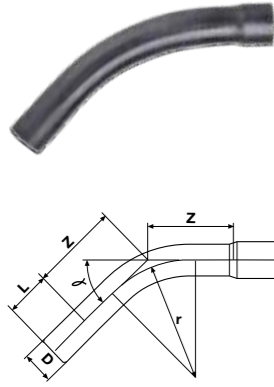
30° PN 10

Çap Dia	Basınç PN	Kod Code	Fiyat (Adet) Price (Pcs)	Açı Angle	Yarıçap R	Z mm	L mm
Emniyet kat sayısı (safety factor) C =2,5							
25	10	107 10 025 6		30°	63	42	18,5
32	10	107 10 032 6		30°	80	53	22
40	10	107 10 040 6		30°	100	67	26
50	10	107 10 050 6		30°	125	84	31
63	10	107 10 063 6		30°	221	84	37,5
75	10	107 10 075 6		30°	263	100	43,5
90	10	107 10 090 6		30°	315	120	51
Emniyet kat sayısı (safety factor) C =2,0							
110	10	107 10 110 6		30°	385	147	61
125	10	107 10 125 6		30°	438	167	68,5
140	10	107 10 140 6		30°	490	187	76
160	10	107 10 160 6		30°	560	214	86
200	10	107 10 200 6		30°	700	268	106
225	10	107 10 225 6		30°	788	301	118,5
250	10	107 10 250 6		30°	875	334	131
280	10	107 10 280 6		30°	980	375	146
315	10	107 10 315 6		30°	1103	421	163,5
355	10	107 10 355 6		30°	1243	475	183,5
400	10	107 10 400 6		30°	1400	535	206
450	10	107 10 450 6		30°	1575	602	
500	10	107 10 500 6		30°	1750	669	

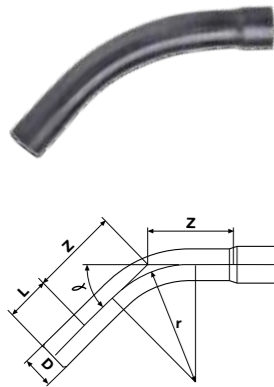
30° PN 16

Çap Dia	Basınç PN	Kod Code	Fiyat (Adet) Price (Pcs)	Açı Angle	Yarıçap R	Z mm	L mm
Emniyet kat sayısı (safety factor) C =2,5							
25	16	107 16 025 6		30°	63	42	18,5
32	16	107 16 032 6		30°	80	53	22
40	16	107 16 040 6		30°	100	67	26
50	16	107 16 050 6		30°	125	84	31
63	16	107 16 063 6		30°	221	84	37,5
75	16	107 16 075 6		30°	263	100	43,5
90	16	107 16 090 6		30°	315	120	51
Emniyet kat sayısı (safety factor) C =2,0							
110	16	107 16 110 6		30°	385	147	61
125	16	107 16 125 6		30°	438	167	68,5
140	16	107 16 140 6		30°	490	187	76
160	16	107 16 160 6		30°	560	214	86
200	16	107 16 200 6		30°	700	268	106
225	16	107 16 225 6		30°	788	301	118,5
250	16	107 16 250 6		30°	875	334	131
280	16	107 16 280 6		30°	980	375	146
315	16	107 16 315 6		30°	1103	421	163,5
355	16	107 16 355 6		30°	1243	475	183,5
400	16	107 16 400 6		30°	1400	535	206
450	16	107 16 450 6		30°	1575	602	
500	16	107 16 500 6		30°	1750	669	

U-PVC Yapıştırma Mufllu Temiz Su Deve Boynu
 U-PVC Solvent Cement Socketed Long Bend

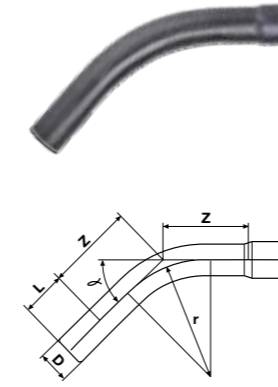
45° PN 10

Çap Dia	Basınç PN	Kod Code	Fiyat (Adet) Price (Pcs)	Açı Angle	Yarıçap R	Z mm	L mm
Emniyet kat sayısı (safety factor) C =2,5							
25	10	108 10 025 6		45°	63	51	18,5
32	10	108 10 032 6		45°	80	65	22
40	10	108 10 040 6		45°	100	81	26
50	10	108 10 050 6		45°	125	102	31
63	10	108 10 063 6		45°	221	117	37,5
75	10	108 10 075 6		45°	263	139	43,5
90	10	108 10 090 6		45°	315	166	51
Emniyet kat sayısı (safety factor) C =2,0							
110	10	108 10 110 6		45°	385	203	61
125	10	108 10 125 6		45°	438	231	68,5
140	10	108 10 140 6		45°	490	259	76
160	10	108 10 160 6		45°	560	296	86
200	10	108 10 200 6		45°	700	370	106
225	10	108 10 225 6		45°	788	416	118,5
250	10	108 10 250 6		45°	875	462	131
280	10	108 10 280 6		45°	980	518	146
315	10	108 10 315 6		45°	1103	583	163,5
355	10	108 10 355 6		45°	1243	656	183,5
400	10	108 10 400 6		45°	1400	740	206
450	10	108 10 450 6		45°	1575	832	
500	10	108 10 500 6		45°	1750	925	

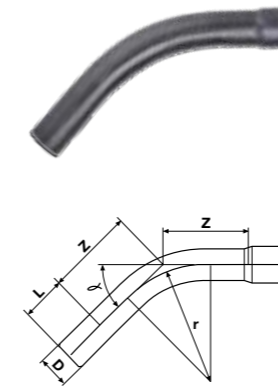
45° PN 16

Çap Dia	Basınç PN	Kod Code	Fiyat (Adet) Price (Pcs)	Açı Angle	Yarıçap R	Z mm	L mm
Emniyet kat sayısı (safety factor) C =2,5							
25	16	108 16 025 6		45°	63	51	18,5
32	16	108 16 032 6		45°	80	65	22
40	16	108 16 040 6		45°	100	81	26
50	16	108 16 050 6		45°	125	102	31
63	16	108 16 063 6		45°	221	117	37,5
75	16	108 16 075 6		45°	263	139	43,5
90	16	108 16 090 6		45°	315	166	51
Emniyet kat sayısı (safety factor) C =2,0							
110	16	108 16 110 6		45°	385	203	61
125	16	108 16 125 6		45°	438	231	68,5
140	16	108 16 140 6		45°	490	259	76
160	16	108 16 160 6		45°	560	296	86
200	16	108 16 200 6		45°	700	370	106
225	16	108 16 225 6		45°	788	416	118,5
250	16	108 16 250 6		45°	875	462	131
280	16	108 16 280 6		45°	980	518	146
315	16	108 16 315 6		45°	1103	583	163,5
355	16	108 16 355 6		45°	1243	656	183,5
400	16	108 16 400 6		45°	1400	740	206
450	16	108 16 450 6		45°	1575	832	
500	16	108 16 500 6		45°	1750	925	

U-PVC Yapıştırma Mufllu Temiz Su Deve Boynu
U-PVC Solvent Cement Socketed Long Bend

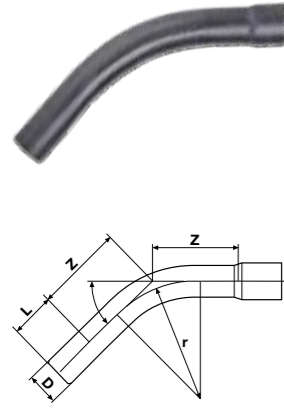
60° PN 10

Çap Dia	Basınç PN	Kod Code	Fiyat (Adet) Price (Pcs)	Açı Angle	Yarıçap R	Z mm	L mm
Emniyet kat sayısı (safety factor) C =2,5							
25	10	109 10 025 6		60°	63	61	18,5
32	10	109 10 032 6		60°	80	78	22
40	10	109 10 040 6		60°	100	98	26
50	10	109 10 050 6		60°	125	122	31
63	10	109 10 063 6		60°	221	153	37,5
75	10	109 10 075 6		60°	263	182	43,5
90	10	109 10 090 6		60°	315	218	51
Emniyet kat sayısı (safety factor) C =2,0							
110	10	109 10 110 6		60°	385	266	61
125	10	109 10 125 6		60°	438	303	68,5
140	10	109 10 140 6		60°	490	339	76
160	10	109 10 160 6		60°	560	387	86
200	10	109 10 200 6		60°	700	484	106
225	10	109 10 225 6		60°	788	545	118,5
250	10	109 10 250 6		60°	875	605	131
280	10	109 10 280 6		60°	980	678	146
315	10	109 10 315 6		60°	1103	763	163,5
355	10	109 10 355 6		60°	1243	859	183,5
400	10	109 10 400 6		60°	1400	968	206
450	10	109 10 450 6		60°	1575	1089	
500	10	109 10 500 6		60°	1750	1210	

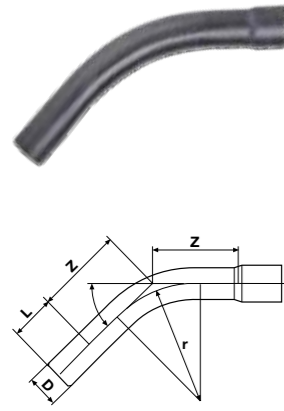
60° PN 16

Çap Dia	Basınç PN	Kod Code	Fiyat (Adet) Price (Pcs)	Açı Angle	Yarıçap R	Z mm	L mm
Emniyet kat sayısı (safety factor) C =2,5							
25	16	109 16 025 6		60°	63	61	18,5
32	16	109 16 032 6		60°	80	78	22
40	16	109 16 040 6		60°	100	98	26
50	16	109 16 050 6		60°	125	122	31
63	16	109 16 063 6		60°	221	153	37,5
75	16	109 16 075 6		60°	263	182	43,5
90	16	109 16 090 6		60°	315	218	51
Emniyet kat sayısı (safety factor) C =2,0							
110	16	109 16 110 6		60°	385	266	61
125	16	109 16 125 6		60°	438	303	68,5
140	16	109 16 140 6		60°	490	339	76
160	16	109 16 160 6		60°	560	387	86
200	16	109 16 200 6		60°	700	484	106
225	16	109 16 225 6		60°	788	545	118,5
250	16	109 16 250 6		60°	875	605	131
280	16	109 16 280 6		60°	980	678	146
315	16	109 16 315 6		60°	1103	763	163,5
355	16	109 16 355 6		60°	1243	859	183,5
400	16	109 16 400 6		60°	1400	968	206
450	16	109 16 450 6		60°	1575	1089	
500	16	109 16 500 6		60°	1750	1210	

U-PVC Yapıştırma Mufllu Temiz Su Deve Boynu
U-PVC Solvent Cement Socketed Long Bend

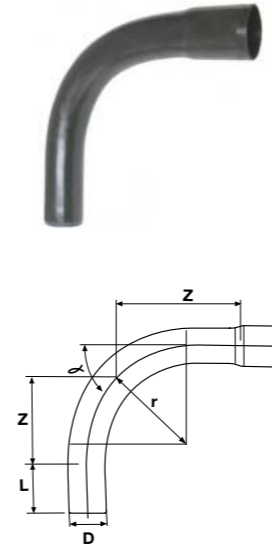
90° PN 10

Çap Dia	Basınç PN	Kod Code	Fiyat (Adet) Price (Pcs)	Açı Angle	Yarıçap R	Z mm	L mm
Emniyet kat sayısı (safety factor) C =2,5							
25	10	110 10 025 6		90°	63	88	18,5
32	10	110 10 032 6		90°	80	112	22
40	10	110 10 040 6		90°	100	140	26
50	10	110 10 050 6		90°	125	175	31
63	10	110 10 063 6		90°	221	246	37,5
75	10	110 10 075 6		90°	263	293	43,5
90	10	110 10 090 6		90°	315	351	51
Emniyet kat sayısı (safety factor) C =2,0							
110	10	110 10 110 6		90°	385	429	61
125	10	110 10 125 6		90°	438	488	68,5
140	10	110 10 140 6		90°	490	546	76
160	10	110 10 160 6		90°	560	624	86
200	10	110 10 200 6		90°	700	780	106
225	10	110 10 225 6		90°	788	878	118,5
250	10	110 10 250 6		90°	875	975	131
280	10	110 10 280 6		90°	980	1092	146
315	10	110 10 315 6		90°	1103	1229	163,5
355	10	110 10 355 6		90°	1243	1385	183,5
400	10	110 10 400 6		90°	1400	1560	206
450	10	110 10 450 6		90°	1575	1755	
500	10	110 10 500 6		90°	1750	1950	

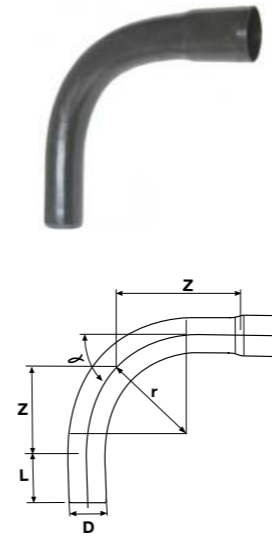
90° PN 16

Çap Dia	Basınç PN	Kod Code	Fiyat (Adet) Price (Pcs)	Açı Angle	Yarıçap R	Z mm	L mm
Emniyet kat sayısı (safety factor) C =2,5							
25	16	110 16 025 6		90°	63	88	18,5
32	16	110 16 032 6		90°	80	112	22
40	16	110 16 040 6		90°	100	140	26
50	16	110 16 050 6		90°	125	175	31
63	16	110 16 063 6		90°	221	246	37,5
75	16	110 16 075 6		90°	263	293	43,5
90	16	110 16 090 6		90°	315	351	51
Emniyet kat sayısı (safety factor) C =2,0							
110	16	110 16 110 6		90°	385	429	61
125	16	110 16 125 6		90°	438	488	68,5
140	16	110 16 140 6		90°	490	546	76
160	16	110 16 160 6		90°	560	624	86
200	16	110 16 200 6		90°	700	780	106
225	16	110 16 225 6		90°	788	878	118,5
250	16	110 16 250 6		90°	875	975	131
280	16	110 16 280 6		90°	980	1092	146
315	16	110 16 315 6		90°	1103	1229	163,5
355	16	110 16 355 6		90°	1243	1385	183,5
400	16	110 16 400 6		90°	1400	1560	206
450	16	110 16 450 6		90°	1575	1755	
500	16	110 16 500 6		90°	1750	1950	

U-PVC Kayar Manşon PN 16

U-PVC Double Socketed Sleeve PN 16

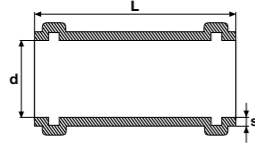

Çap Dia	Basınç PN	Kod Code	Fiyat (Adet) Price (Pcs)	Koli/ Adet Box/Pcs	Kg/Adet Kg/Pcs	S (mm)	L (mm)
*50	16	117 00 050 6		30	0,170	3,7	180
63	16	117 00 063 2		32	0,350	4,7	225
75	16	117 00 075 2		22	0,560	5,6	255
90	16	117 00 090 2		15	0,940	6,7	275
110	16	117 00 110 2		10	1,060	6,6	290
*125	16	117 00 125 6		7	1,670	7,4	290
*140	16	117 00 140 6		5	2,130	8,3	355
160	16	117 00 160 2		3	2,440	9,5	310
*200	16	117 00 200 5		2	4,100	11,9	338
*225	16	117 00 225 5		1	5,500	13,4	360
*250	16	117 00 250 5		1	7,230	14,8	385
*280	16	117 00 280 5		1	10,210	16,6	460
*315	16	117 00 315 6		1	13,730	18,7	460
*355	16	117 00 355 2		1	22,020	21,1	562
*400	16	117 00 400 6		1	27,990	23,7	602

Konfeksiyon. Hand-made from pipe
Conta dahil değildir. Gasket is not included the price.

EPDM Temiz Su Borusu Üçgen Conta

EPDM Rubber Triangle Gasket

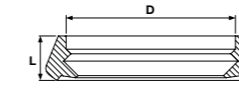

Çap Dia	Kod Code	Fiyat (Adet) Price (Pcs)	Koli/ Adet Box/Pcs	L (mm)
50	101 00 050 8			14
63	101 00 063 8		300	16,5
75	101 00 075 8		240	19,5
90	101 00 090 8		120	22
110	101 00 110 8		80	24
125	101 00 125 8		64	25
140	101 00 140 8		50	26
160	101 00 160 8		44	27
200	101 00 200 8		40	30,5
225	101 00 225 8		25	33
250	101 00 250 8		20	36
280	101 00 280 8		30	
315	101 00 315 8		40	
355	101 00 355 8		25	
400	101 00 400 8		25	
450	101 00 450 8			
500	101 00 500 8			

EPDM Temiz Su Borusu Kare Conta

EPDM Rubber Ring Gasket

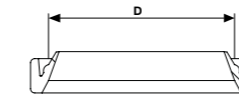

Çap Dia	Kod Code	Fiyat (Adet) Price (Pcs)	Koli/ Adet Box/Pcs
50	101 00 050 9		
63	101 00 063 9		300
75	101 00 075 9		240
90	101 00 090 9		120
110	101 00 110 9		80
125	101 00 125 9		64
140	101 00 140 9		50
160	101 00 160 9		44
200	101 00 200 9		40
225	101 00 225 9		25
250	101 00 250 9		20
280	101 00 280 9		30
315	101 00 315 9		40
355	101 00 355 9		25
400	101 00 400 9		25
450	101 00 450 9		
500	101 00 500 9		

Not / Note

KELEPÇELER PIPE CLAMP

ÜRETİM STANDARDI
PRODUCTION STANDARD | EN 1452-2

ÇAP / SIZE Ø20 - Ø200



Boru Kelepçesi
Pipe Clamp

YENİ / NEW



Model A

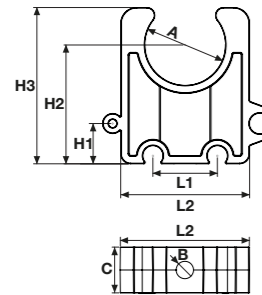

Model B

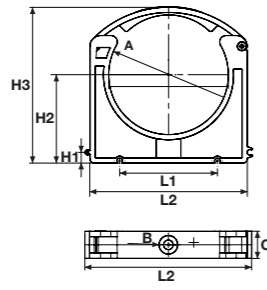

Model C

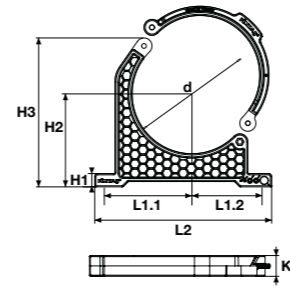

Model A

Çap Dia	Kod Code	Fiyat (Adet) Price (Pcs)	A (mm)	B (mm)	C (mm)	L1 (mm)	L2 (mm)	H1 (mm)	H2 (mm)	H3 (mm)
20	118 00 020 4		20	5,5	14,5	16	32	10	29,5	38,9
25	118 00 025 4		25	5,5	14,5	20	37	10	32	42,15
32	118 00 032 4		32	5,5	14,5	24	46	10	35,5	47,5

Model B

Çap Dia	Kod Code	Fiyat (Adet) Price (Pcs)	A (mm)	B (mm)	C (mm)	L1 (mm)	L2 (mm)	H1 (mm)	H2 (mm)	H3 (mm)
40	118 00 040 4		40	6,5	18	30	56	10	46,5	70,4
50	118 00 050 4		50	6,5	20	40	66	10	51,5	80,4
63	118 00 063 4		63	8,5	22	50	82	10	58	92,9
75	118 00 075 4		75	8,5	23	60	96	10	64	106,9
90	118 00 090 4		90	8,5	23	70	115	10	71,5	124,4
110	118 00 110 4		110	8,5	25	90	145	10	81,5	143,8
125	118 00 125 4		125	8,5	28	120	165	10	90	161,6
140	118 00 140 4		140	8,5	28	125	185	10	100	180,7
160	118 00 160 4		160	8,5	28	140	209	10	110	200,8
200	118 00 200 4		200	8,5	28	160	255	10	130	241,6

Model C

Çap Dia	Kod Code	Fiyat (Adet) Price (Pcs)	L1/1 (mm)	L1/2 (mm)	L2 (mm)	H1 (mm)	H2 (mm)	H3 (mm)	K (mm)
225	118 00 225 4		165	132	333	25	175	265,23	39
250	118 00 250 4		185	155	366	25	200	314,17	39
280	118 00 280 4		200	156	392	25	200	320,81	39
315	118 00 315 4		220	172	428	25	229	362,18	39

Boru Kelepçesi Yükseltme Kiti
Pipe Clamp Lifting Kit

YENİ / NEW

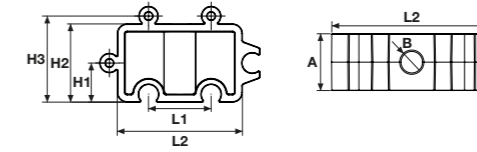

Çap Dia	Kod Code	Fiyat (Adet) Price (Pcs)	A (mm)	B (mm)	L1 (mm)	L2 (mm)	H1 (mm)	H2 (mm)	H3 (mm)	Ağırlık (gr)
20	118 01 020 4		14,5	5,5	16	32	10	20	22	4,34
25	118 01 025 4		14,5	5,5	20	37	10	20	22	4,75
32	118 01 032 4		14,5	5,5	24	46	10	20	22	6,22
40	118 01 040 4		18	6,5	30	56	10	20	22	8,85
50	118 01 050 4		20	6,5	40	66	10	20	22	11,25
63	118 01 063 4		22	8,5	50	82	10	20	22	16,54
75	118 01 075 4		23	8,5	60	96	10	20	22	20,67
90	118 01 090 4		23	8,5	70	115	10	20	22	24,9
110	118 01 110 4		25	8,5	90	145	10	20	22	35,03

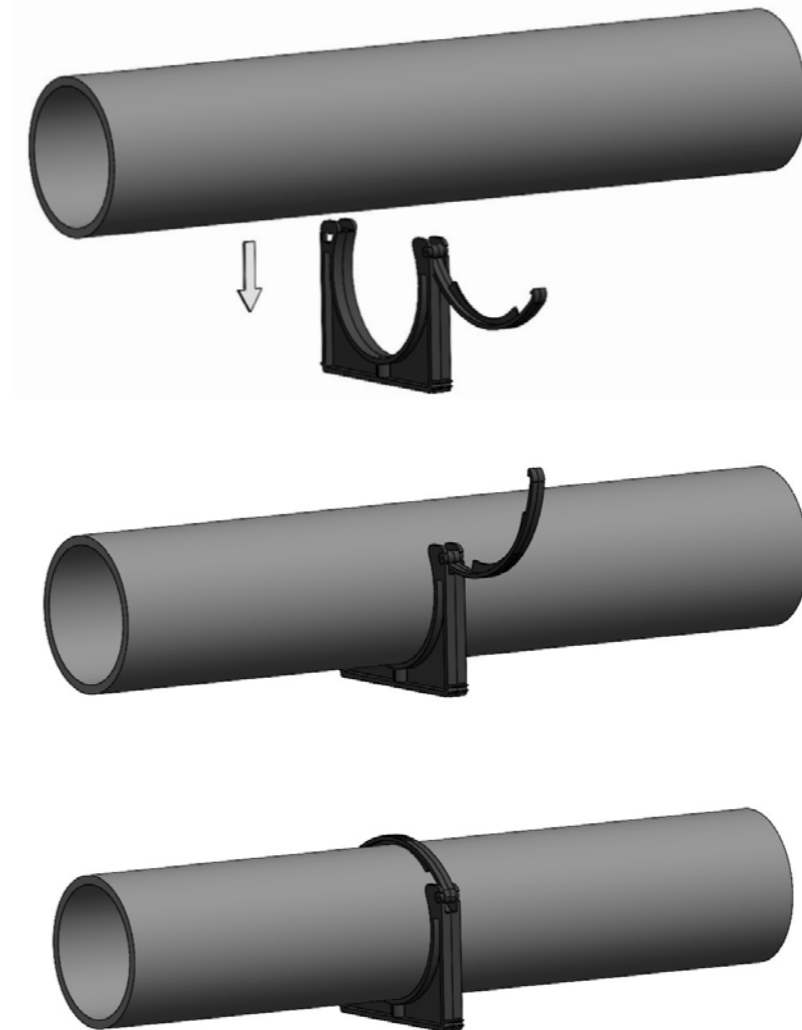

Somun Kelepçe (Metal)
 Metal Clamp With Nut

Çap Dia	Kod Code	Fiyat (Adet) Price (Pcs)	Koli/Adet Box/Pcs	Kg/Adet Kg/Pcs	Sıkma Aralığı	Çap (mm)	Askı Somunu	Saç (mm)	Bağlantı vidası
20	119 00 020 8		200	0,057	20-24	21	M8	1,5x20	M5
25	119 00 025 8		200	0,06	25-28	27	M8	1,5x20	M5
32	119 00 032 8		150	0,07	32-35	34	M8	1,5x20	M5
40	119 00 040 8		100	0,087	39-46	42	M8	1,5x20	M6
50	119 00 050 8		100	0,096	48-53	48	M8	1,5x20	M6
63	119 00 063 8		75	0,112	56-66	60	M8	1,5x20	M6
75	119 00 075 8		30	0,171	75-80	76	M10	2x25	M6
90	119 00 090 8		30	0,189	86-94	89	M10	2x25	M6
110	119 00 110 8		25	0,312	110-116	114	M10	2,5x25	M6
125	119 00 125 8		25	0,256	123-126	120	M10	2,5x25	M6
140	119 00 140 8		25	0,36	135-143	140	M10	2,5x25	M6
160	119 00 160 8		25	0,342	163-170	165	M10	2,5x25	M6
200	119 00 200 8		25	0,377	207-219	219	M10	2,5x25	M6

Somunlu Ağır Yük Kelepçesi (Metal)
 Metal Clamp With Nut Heavy Load

Çap Dia	Kod Code	Fiyat (Adet) Price (Pcs)	Koli/Adet Box/Pcs	Kg/Adet Kg/Pcs	Sıkma Aralığı	Çap (mm)	Askı Somunu	Saç (mm)	Bağlantı vidası
20	119 01 020 8		50		21-28	30	M12	2x25	M8
25	119 01 025 8		50	1	25-32	33	M12	2x25	M8
32	119 01 032 8		50	1,5	33-40	36,5	M12	2x25	M8
40	119 01 040 8		50	1	41-48	41	M12	2x25	M8
50	119 01 050 8		40	0,28	48-56	44,5	M12	2x25	M8
63	119 01 063 8		30	0,39	60-69	51	M12	2x25	M8
75	119 01 075 8		30	0,35	75-81	59	M12	2x25	M8
90	119 01 090 8		30	0,39	87-95	65	M12	2x25	M8
110	119 01 110 8		30	0,45	109-119	78,6	M12	2,5x30	M8
125	119 01 125 8		10	0,65	136-147	96,1	M16	3x30	M10
140	119 01 140 8		10	0,75	153 - 164	104,1	M16	3x30	M10
160	119 01 160 8		10	1,1	164-174	108,6	M16	3x30	M10
200	119 01 200 8		15	2,5	214-226	133,6	M16	3x30	M10

Trifonlu Kelepçe
 Metal Clamp With Screw

Çap Dia	Kod Code	Fiyat (Adet) Price (Pcs)	Koli/Adet Box/Pcs	Kg/Adet Kg/Pcs	Sıkma Aralığı	Çap (mm)	Askı Somunu	Saç (mm)	Bağlantı vidası
20	120 00 020 8		100	0,06	20-24	21	8x60	1,5x20	M5
25	120 00 025 8		100	0,066	25-28	27	8x60	1,5x20	M5
32	120 00 032 8		75	0,076	32-35	34	8x60	1,5x20	M5
40	120 00 040 8		50	0,082	39-46	42	8x60	1,5x20	M6
50	120 00 050 8		50	0,092	48-53	48	8x60	1,5x20	M6
63	120 00 063 8		50	0,103	56-66	60	8x60	1,5x20	M6
75	120 00 075 8		50	0,168	75-80	76	8x60	2x25	M6
90	120 00 090 8		25	0,182	86-94	89	8x60	2x25	M6
110	120 00 110 8		25	0,237	110-116	114	8x60	2,5x25	M6
125	120 00 125 8		25	0,265					M6
140	120 00 140 8		25	0,85					M6

Uzun Trifonlu Kelepçe
 Metal Clamp With Screw Long Bolt

Çap Dia	Kod Code	Fiyat (Adet) Price (Pcs)	Koli/Adet Box/Pcs	Kg/Adet Kg/Pcs	Sıkma Aralığı	Çap (mm)	Askı Somunu	Saç (mm)	Bağlantı vidası
20	120 01 020 8		150	0,07	20-24	21	8x60	1,5x20	M5
25	120 01 025 8		150	0,08	25-28	27	8x60	1,5x20	M5
32	120 01 032 8		100	0,09	32-35	34	8x60	1,5x20	M5
40	120 01 040 8		75	0,09	39-46	42	8x60	1,5x20	M6
50	120 01 050 8		75	0,09	48-53	48	8x60	1,5x20	M6
63	120 01 063 8		50	0,11	56-66	60	8x60	1,5x20	M6
75	120 01 075 8		30	0,12	75-80	76	8x60	2x25	M6
90	120 01 090 8		30	0,22	86-94	89	8x60	2x25	M6
110	120 01 110 8		25	0,23	110-116	114	8x60	2,5x25	M6

Somunlu Ağır Yük Kelepçesi (Kafalı)
 Metal Clamp With Nut Heavy Load

Çap Dia	Kod Code	Fiyat (Adet) Price (Pcs)	Koli/Adet Box/Pcs	Kg/Adet Kg/Pcs	Sıkma Aralığı	Çap (mm)	Askı Somunu	Saç (mm)	Bağlantı vidası
50	119 02 050 8		50	0,28	48-58	48	M8	1,5x20	M6
63	119 02 063 8		40	0,39	56-60	60	M8	1,5x20	M6
75	119 02 075 8		25	0,2352	75-80	76	M10	2x25	M6
90	119 02 090 8		25	0,2364	86-91	89	M10	2x25	M6
110	119 02 110 8		25	0,236	110-115	114	M10	2,5x25	M6
125	119 02 125 8		10		123-126	120	M10	2,5x25	M6
140	119 02 140 8		10	1,07	138-142	140	M10	2,5x25	M6
160	119 02 160 8		10	1,1	160-165	165	M10	2,5x25	M6
200	119 02 200 8		5		195-200	219	M10	2,5x25	M6

Sprinkler Kelepçe
 Springs Installation Clamp

Çap Dia	Kod Code	Fiyat (Adet) Price (Pcs)	Koli/Adet Box/Pcs	Kg/Adet Kg/Pcs	Sıkma Aralığı	Çap (mm)	Askı Somunu	Saç (mm)	Bağlantı vidası
25	119 03 025 8		100	0,06	25-28	27	M8	1,5x20	M5
32	119 03 032 8		100	0,07	32-35	34	M8	1,5x20	M5
40	119 03 040 8		100	0,08	40-45	42	M8	1,5x20	M6
50	119 03 050 8		75	0,09	48-58	48	M8	1,5x20	M6
63	119 03 063 8		50	0,1	56-60	60	M8	1,5x20	M6
75	119 03 075 8		50	0,11	75-80	76	M10	2x25	M6
90	119 03 090 8		50	0,15	86-91	89	M10	2x25	M6
110	119 03 110 8		25	0,21	110-115	114	M10	2,5x25	M6
140	119 03 140 8		25	0,23	138-142	140	M10	2,5x25	M6
160	119 03 160 8		25	0,45	160-165	165	M10	2,5x25	M6

U Bolt
 U Bolt

Çap Dia	Kod Code	Fiyat (Adet) Price (Pcs)	Koli/Adet Box/Pcs	Kg/Adet Kg/Pcs	d	L	Açma Aralığı
1/2"	119 04 020 8		100	0,02	M-6		24
3/4"	119 04 025 8		100	0,02	M-6		30
1"	119 04 032 8		100	0,05	M-8		36
1 1/4"	119 04 040 8		70	0,05	M-8		46
1 1/2"	119 04 050 8		50	0,06	M-8		52
2"	119 04 063 8		50	0,12	M-10		64
2 1/2"	119 04 075 8		30	0,14	M-10		78
3"	119 04 090 8		25	0,25	M-12		94
4"	119 04 110 8		25	0,28	M-12		118
5"	119 04 140 8		10	0,35	M-12		146
6"	119 04 160 8		10	0,71	M-16		172
8"	119 04 225 8		10	0,95	M-16		224
10"	119 04 280 8		5	1,20	M-16		278
12"	119 04 315 8		5	1,60	M-16		328

C Kanal
 Canal C

Kod Code	Fiyat (Adet) Price (Pcs)	a (mm)	b (mm)	m (mm)	L (mm)	Uzunluk Length
119 00 001 8		27	18	1,25	2000	2000
119 00 002 8		28	30	1,75	2000	2000
119 00 003 8		38	40	2,00	2000	2000

U Kanal
 Canal U

Kod Code	Fiyat (Adet) Price (Pcs)	a (mm)	b (mm)	m (mm)	L (mm)	Uzunluk Length
119 00 004 8		30	30	3	2000	2000
119 00 005 8		40	40	3	2000	2000
119 00 006 8		40	40	4	2000	2000
119 00 007 8		50	40	4	2000	2000

L Kanal
 Canal L

Kod Code	Fiyat (Adet) Price (Pcs)	a (mm)	b (mm)	m (mm)	L (mm)	Uzunluk Length
119 00 008 8		30	30	3	2000	2000
119 00 009 8		40	40	3	2000	2000
119 00 010 8		40	40	4	2000	2000
119 00 011 8		50	50	4	2000	2000

Boru Gömleklİ Dübel
 Sleeve Pipe Anchor

Çap Dia	Kod Code	Fiyat (Adet) Price (Pcs)	Koli/Adet Box/Pcs	D	d	L
M-6	119 00 024 8		100	10	6	65
M-8	119 00 025 8		100	13	8	65
M-10	119 00 026 8		100	15	10	85
M-12	119 00 027 8		100	16	12	90

Çakmalı Dübel
 Drop-In Anchor

Çap Dia	Kod Code	Fiyat (Adet) Price (Pcs)	Koli/Adet Box/Pcs	D (mm)	d (mm)	L (mm)
M-6	119 00 012 8		100	8	6	30
M-8	119 00 013 8		100	10	8	35
M-10	119 00 014 8		100	12	10	40
M-12	119 00 015 8		100	15	12	50

Çekmeceli Dübel
 Cavity Anchor

Çap Dia	Kod Code	Fiyat (Adet) Price (Pcs)	Koli/Adet Box/Pcs	D (mm)	d (mm)	L (mm)
M-6	119 00 016 8		100	10	6	30
M-8	119 00 017 8		100	13	8	35
M-10	119 00 018 8		100	15	10	45
M-12	119 00 019 8		100	17	12	50

Saç Gömleklİ Dübel
 Sleeve Sheet Anchor

Çap Dia	Kod Code	Fiyat (Adet) Price (Pcs)	Koli/Adet Box/Pcs	D (mm)	d (mm)	L (mm)
M-6	119 00 020 8		100	8	6	65
M-8	119 00 021 8		100	10	8	65
M-10	119 00 022 8		100	12	10	85
M-12	119 00 023 8		100	16	12	90

Gijon (Galvanizli)
 Gijon (Galvenised)

Çap Dia	Kod Code	Fiyat (Adet) Price (Pcs)	Uzunluk Length
M6 x 1000	119 00 112 8		1000
M8 x 1000	119 00 111 3		1000
M10 x 1000	119 00 111 4		1000
M12 x 1000	119 00 111 5		1000
M16 x 1000	119 00 111 6		1000

Not / Note

TEKNİK MALZEMELER TECHNICAL MATERIALS



PVC-U Yapıştırıcı 1000 Gr
PVC-U Solvent 1000 Gr



ML / L	Kod Code	Fiyat (Adet) Price (Pcs)	Koli /Adet Box/Pcs
1000	13 01 10 00 8		8
500	13 01 05 00 8		12
250	13 01 02 50 8		24

PVC-U Temizleyici
PVC-U Cleaner 1000 Gr



Kg	Kod Code	Fiyat (Adet) Price (Pcs)	Koli /Adet Box/Pcs
1000	13 10 0100 8		12

U-PVC Boruların Birbirine Eklenmesi
Connection Of U-PVC Pipes



1) Öncelikle birbirine yapıştırılacak olan parçaların yapıştırma bölgeleri temizleyici sıvı kullanılarak bütün toz, yağ, pislik ve çapaklardan temizlenir.

1) First of all the glueign parts have to be clean by cleanser liquid for purge the parts from dust, oil and bur.



2) Yapıştırma alanı muf boyuna göre işaretlenir.

2) Glueing area has to marked accord-ing to solvent cement socket connection lenght.



3) Yapıştırılacak olan her iki parça üzerinde yapıştırma bölgeleri uygun bir şekilde zımparalanır. Zımparalama işleminden sonra tekrar temizleme sıvısı ile yapıştırma bölgeleri temizlenir ve kurulanır.

3) On both of two parts, glueing area have to rubbing with sand-paper. After rubbing pro-cess glueing areas have to be clean by cleanser liquid and to be dry.



4) Yapıştırılacak olan her iki parça üzerine temiz bir fırça ile boylamasına olarak yapıştırıcı sürülür. Parçalar üzerine gereğinden fazla yapıştırıcı sürüldüyse bu fazla sürülen yapıştırıcı kutusuna geri alınır.

4) Pimtaş Solvent Cement has to apply on two glueing areas with a clear brush as lon-gitudional. In case of pouring, excess glue should be taken back into the glue can.



5) Yapıştırıcı uygun bir şekilde sürüldükten sonra parçalar hiç beklemeden hızlı bir şekilde ve döndürülmeden birbiri içine itilir.

5) After correct application of glue, parts must pushing each other as nonstop, straightly and very quickly.



6) Parçalar birbiri içine itilince dışarı taşan fazla yapıştırıcı temizlenir.

6) Later on pushed parts to inside each other and came off over glue should be cleaning.

U-PVC Plaka (Koyu Gri)
U-PVC Plate (Dark Grey)



Çap Dia	Kod Code	Fiyat (Adet) Price (Pcs)	Plaka Ölçüsü Plate Dia 2000x1000 kg	Plaka Ölçüsü Plate Dia 3000x1500 kg
3	127 00 003 3		8,64	19,44
4	127 00 004 3		11,52	25,92
5	127 00 005 3		14,40	32,40
6	127 00 006 3		17,28	38,88
7	127 00 007 3		20,16	45,36
8	127 00 008 3		23,04	51,84
10	127 00 010 3		28,80	64,80
12	127 00 012 3		34,56	77,76
15	127 00 015 3		43,20	97,20
20	127 00 020 3		57,60	129,60
25	127 00 025 3		72,00	162,00
30	127 00 030 3		86,40	194,40

PP Plaka (Bej)
PP Plate (Beige)



Çap Dia	Kod Code	Fiyat (Adet) Price (Pcs)	Plaka Ölçüsü Plate Dia 2000x1000 kg	Plaka Ölçüsü Plate Dia 3000x1500 kg
3	127 01 003 3		5,55	12,56
4	127 01 004 3		7,42	16,74
5	127 01 005 3		9,29	20,93
6	127 01 006 3		11,09	25,11
7	127 01 007 3			
8	127 01 008 3		14,88	33,48
10	127 01 010 3		18,61	41,85
12	127 01 012 3		22,32	50,22
15	127 01 015 3		27,91	62,78
20	127 01 020 3		37,19	83,72
25	127 01 025 3		46,49	104,47
30	127 01 030 3		55,81	125,56

HDPE Plaka (Siyah)
HDPE Plate (Black)



Çap Dia	Kod Code	Fiyat (Adet) Price (Pcs)	Plaka Ölçüsü Plate Dia 2000x1000 kg	Plaka Ölçüsü Plate Dia 3000x1500 kg
3	127 02 003 3		5,76	12,96
4	127 02 004 3		7,65	17,28
5	127 02 005 3		9,62	21,62
6	127 02 006 3		11,52	25,93
7	127 02 007 3			
8	127 02 008 3		15,36	34,56
10	127 02 010 3		19,21	43,22
12	127 02 012 3		23,04	51,88
15	127 02 015 3		28,81	64,83
20	127 02 020 3		38,41	86,45
25	127 02 025 3		48,01	108,01
30	127 02 030 3		57,61	129,65

U-PVC İçi Dolu Kütük (Beyaz)
U-PVC Solid Rod (White)



Çap Dia	Kod Code	Fiyat (Kg) Price (Kg)	Kg/m
10	126 00 010 3		0,110
12	126 00 012 3		0,180
15	126 00 015 3		0,275
16	126 00 016 3		0,300
18	126 00 018 3		0,378
20	126 00 020 3		0,500
22	126 00 022 3		0,600
25	126 00 025 3		0,750
28	126 00 028 3		0,900
30	126 00 030 3		1,050
32	126 00 032 3		1,170
35	126 00 035 3		1,350
36	126 00 036 3		1,500
40	126 00 040 3		1,900
45	126 00 045 3		2,400
50	126 00 050 3		2,900
55	126 00 055 3		3,500
60	126 00 060 3		4,200

Kütük Uzunluğu 2 m/adet / Solid Rod Length 2 m/pcs

HDPE İçi Dolu Kütük (Siyah)
HDPE Solid Rod (Black)



Çap Dia	Kod Code	Fiyat (Kg) Price (Kg)	Kg/m
10	126 02 010 3		
12	126 02 012 3		
15	126 02 015 3		
16	126 02 016 3		
18	126 02 018 3		
20	126 02 020 3		
22	126 02 022 3		
25	126 02 025 3		
28	126 02 028 3		
30	126 02 030 3		
32	126 02 032 3		
35	126 02 035 3		
36	126 02 036 3		
40	126 02 040 3		
45	126 02 045 3		
50	126 02 050 3		
55	126 02 055 3		
60	126 02 060 3		

Kütük Uzunluğu 2 m/adet / Solid Rod Length 2 m/pcs

PP İçi Dolu Kütük (Bej)
PP Solid Rod (Beige)



Çap Dia	Kod Code	Fiyat (Kg) Price (Kg)	Kg/m
10	126 01 010 3		0,078
12	126 01 012 3		0,114
15	126 01 015 3		0,176
16	126 01 016 3		0,195
18	126 01 018 3		
20	126 01 020 3		0,312
22	126 01 022 3		
25	126 01 025 3		0,484
28	126 01 028 3		
30	126 01 030 3		0,694
32	126 01 032 3		0,767
35	126 01 035 3		0,947
36	126 01 036 3		
40	126 01 040 3		1,230
45	126 01 045 3		1,560
50	126 01 050 3		1,950
55	126 01 055 3		2,300
60	126 01 060 3		2,800

Kütük Uzunluğu 2 m/adet / Solid Rod Length 2 m/pcs

Sıcak Hava Kaynak Makinesi ve Aksesuarları
Hot Air Welding Machine and Accessories



Parça Adı Description Of Item	Kod Code	Fiyat (Adet) Price (Pcs)
Elektronik El Kaynak Makinası Electronic Hot Air Welding Machine	128 00 1500 8	
Test Cihazı / Test Equipment	128 01 0000 8	
50x300x2,5 mm Ağzılık / Nozzle	128 02 4000 8	
50x150 mm Ağzılık / Nozzle	128 03 4002 8	
40 mm Ağzılık / Nozzle	128 04 4003 8	
40 mm Merdane / Runner	128 05 5010 8	
50x70 mm Ağzılık / Nozzle	128 06 5011 8	
90° Ağzılık / Nozzle	128 07 5012 8	
20° Ağzılık / Nozzle	128 08 5015 8	
5 mm Yuvarlak Ağzılık / Rounded Nozzle	128 09 7001 8	
5 mm Çatal Ağzılık / Slotted Nozzle	128 01 0001 8	
7,5 mm Üçgen Ağzılık / Triangular Nozzle	128 01 0002 8	
Mantar / Cork	128 01 0003 8	

Teknik Veriler
Technical Specifications

Gerilim / Voltage	V	220/230
Güç / Power	W	1550
Frekans / Frequency	Hz	50/60
Isı Ayar Aralığı / Heat Adjustment Step	°C	20-650
Hava Akımı / Air Flow	l/dak	~250
Statik Basınç / Statical Pressure	Pa	~3000
Gürültü Seviyesi / Noise Level	dB	64
Ağırlık / Weight	kg	1,3(kabloyla)/(with cable)
İşaretleme / Marking		CE

U-PVC Kaynak Çubuğu
 U-PVC Welding Rods

Çap Dia	Kod Code	Fiyat (Adet) Price (Pcs)	Kg /Koli Kg/Box
3	123 00 003 1		2
4	123 00 004 1		2
5	123 00 005 1		2
6	123 00 006 1		2
7	123 00 007 1		2
8	123 00 008 1		2
9	123 00 009 1		2
10	123 00 010 1		2
12	123 00 012 1		2

PE Kaynak Çubuğu
 PE Welding Rods

Çap Dia	Kod Code	Fiyat (Adet) Price (Pcs)	Kg /Koli Kg/Box
3	124 00 003 1		5
4	124 00 004 1		5

PP Kaynak Çubuğu
 PP Welding Rods

Çap Dia	Kod Code	Fiyat (Adet) Price (Pcs)	Kg /Koli Kg/Box
3	125 00 003 1		5
4	125 00 004 1		5
3	125 00 003 1		5
4	124 00 004 1		5

U-PVC Flanşlı Ön Filtre (Pislik Tutucu)
 U-PVC Prefilters With Flange

d (mm)	Kod Code	Fiyat (Adet) Price (Pcs)	Koli/kg Box/kg	Koli /Adet Kg/Pcs	D (mm)	H (mm)
63	729 00 063 5		15,25	1	280	37
75	729 00 075 5		15,25	1	280	37
90	729 00 090 5		15,30	1	280	37
110	729 00 110 5		15,35	1	315	37
125	729 00 125 5		19,20	1	315	37
140	729 00 140 5		19,25	1	315	48
160	729 00 160 5		21,20	1	315	48

*Konfeksiyon / Hand-made

304 Paslanmaz Çelik Ön Filtre
 304 Stainless Steel Prefilter

d (mm)	Kod Code	Fiyat (Adet) Price (Pcs)	Koli /Adet Kg/Pcs
75	729 01 075 5		1
90	729 01 090 5		1
110	729 01 110 5		1
140	729 01 140 5		1
160	729 01 160 5		1
225	729 01 225 5		1

PP Flanşlı Ön Filtre
 PP Prefilters With Flange

d (mm)	Kod Code	Fiyat (€/Adet) Price (€/Pcs)	Koli /Adet Kg/Pcs
90-110	729 90 110 5		1

Hava Emiş Vanası (Vakum)
 Air Suction Valve (Vacuum)

d (mm)	Kod Code	Fiyat (Adet) Price (Pcs)	Kg /Adet Kg/Pcs	Koli/Adet Box/Pcs
1" Tek Hareket (Step)	729 02 032 2			30
2" Tek Hareket (Step)	729 02 063 2			14
1" Çift Hareketli (Double Steps)	729 12 032 2			30
2" Çift Hareketli (Double Steps)	729 12 063 2			14

Hava Purjörü
 Air Reliff Cock

Kod Code	Fiyat (Adet) Price (Pcs)	Kg /Adet Kg/Pcs	Koli/Adet Box/Pcs
729 02 000 0	5,40 €		1

Manometre
 Manometer

d (mm)	Kod Code	Fiyat (Adet) Price (Pcs)	Kg /Adet Kg/Pcs	Koli/Adet Box/Pcs
3 bar	729 02 000 3			1
10 bar	729 02 001 0			1

Tesisat Keteni (1.Kalite)
 Flax Fiber (First Quality)

Kod Code	Fiyat (Adet) Price (Pcs)	Çuval/kg Sack/Kg
EX70006606		25
EX70006603		50

Teflon Bant
 Teflon Tape

Çap Dia	Kod Code	Fiyat (Adet) Price (Pcs)	Koli Adet Box Pcs
12x10	EX70006800		1000
12x20	EX70006801		1000
19x50	EX70006802		250

Not / Note

UH-PVC

CONTALI EK PARÇALAR GASKET SOCKETED FITTINGS

ÜRETİM STANDARDI
PRODUCTION STANDARD | EN 1452-3

ÇAP / SIZE Ø20 - Ø400



 **PIMTA5**[®]

Since 1977

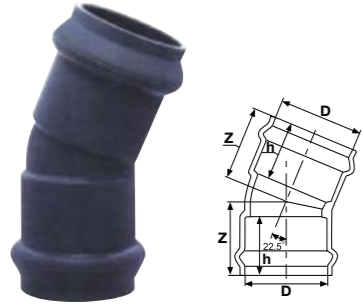
U-PVC 22,5° Geçme Mufllu Dirsek F/F
 UH-PVC 22,5° Elbow With Rubber-Ring F/F

Çap Dia	Basınç PN	Kod Code	Fiyat (Adet) Price (Pcs)	Kg /Adet Kg/Pcs	Koli/Adet Box/Pcs	Z (mm)	h (mm)
110	10	600 00 110 4		18,5	11	152	122
160	10	600 00 160 4		17,4	5	166	140
200	10	600 00 200 4		23,5	4	190	155
225	10	600 00 225 4		13,9	2	191	166
250	10	600 00 250 4		16,9	2	224	180
315	10	600 00 315 4		15,9	1	268	198

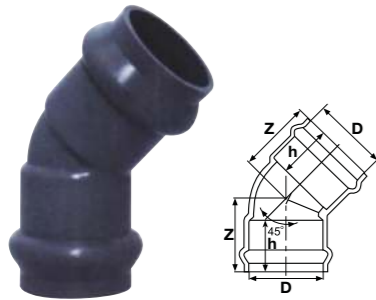
U-PVC 45° Geçme Mufllu Dirsek F/F
 UH-PVC 45° Elbow With Rubber-Ring F/F

Çap Dia	Basınç PN	Kod Code	Fiyat (Adet) Price (Pcs)	Kg /Adet Kg/Pcs	Koli/Adet Box/Pcs	Z (mm)	h (mm)
63	10	601 00 063 4		14,5	36	92	76
75	10	601 00 075 4		13,5	20	103	81,5
90	10	601 00 090 4		19,5	18	136	114
110	10	601 00 110 4		1,82	9	162	122
160	10	601 00 160 4		19,0	5	183	141
200	10	601 00 200 4		19,4	3	210	155
225	10	601 00 225 4		15,0	2	222	166
250	10	601 00 250 4		18,5	2	248	180
315	10	601 00 315 4		17,4	1	298	195
355	10	601 00 355 4		19,2	1	292	205

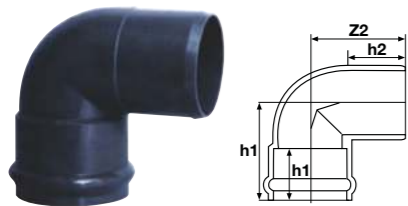
U-PVC 90° Geçme Mufllu Dirsek M/F
 UH-PVC 90° Elbow With Rubber-Ring M/F

Çap Dia	Basınç PN	Kod Code	Fiyat (Adet) Price (Pcs)	Kg /Adet Kg/Pcs	Koli/Adet Box/Pcs	Z1 (mm)	Z2 (mm)	h1 (mm)	h2 (mm)
225	10	603 00 225 4		16,5	2	312	296	166	170
250	10	603 00 250 4		16,5	2	337	340	182	178
355	10	603 00 355 4		16,5	1	393	378	198	222

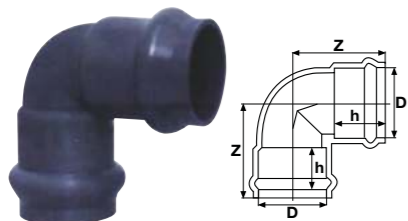
U-PVC 90° Geçme Mufllu Dirsek F/F
 UH-PVC 90° Elbow With Rubber-Ring F/F

Çap Dia	Basınç PN	Kod Code	Fiyat (Adet) Price (Pcs)	Kg /Adet Kg/Pcs	Koli/Adet Box/Pcs	Z (mm)	h (mm)
63	10	602 00 063 4		18,8	42	112	76
75	10	602 00 075 4		20,0	18	123	81,5
90	10	602 00 090 4		0,65	28	165	114
110	10	602 00 110 4		2,00	8	190	122
160	10	602 00 160 4		16,3	4	229	142
200	10	602 00 200 4		1,00	3	266	153
225	10	602 00 225 4		19,7	2	312	163
250	10	602 00 250 4		11,5	2	338	177
315	10	602 00 315 4		19,7	1	393	198
355	10	602 00 355 4		23,2	1	393	206

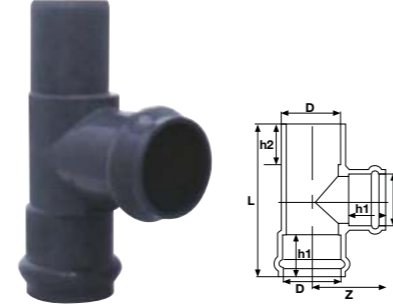
U-PVC 90° Geçme Mufllu Te M/F/F
 UH-PVC 90° Elbow With Rubber-Ring M/F/F

Çap Dia	Basınç PN	Kod Code	Fiyat (Adet) Price (Pcs)	Kg /Adet Kg/Pcs	Koli/Adet Box/Pcs	L (mm)	Z (mm)	h1 (mm)	h2 (mm)
110	10	604 00 110 4		24,4	5	410	206	122	130
160	10	604 00 160 4		24,4	3	480	238	141	144
200	10	604 00 200 4		24,4	2	560	280	155	155
225	10	604 00 225 4		24,4	2	615	308	166	167
250	10	604 00 250 4		24,4	2	670	333	180	182
315	10	604 00 315 4		24,4	1	780	390	198	198

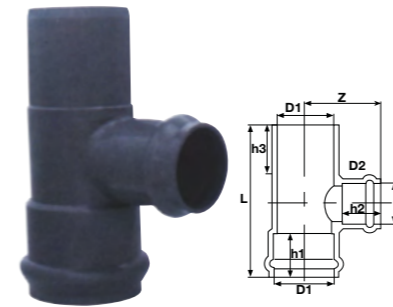
U-PVC 90° Geçme Mufllu İnegal Te M/F/F
 UH-PVC 90° Reducing Tee With Rubber-Ring M/F/F

Çap Dia	Basınç PN	Kod Code	Fiyat (Adet) Price (Pcs)	Kg /Adet Kg/Pcs	Koli/Adet Box/Pcs	L (mm)	Z (mm)	h1 (mm)	h2 (mm)	h3 (mm)
160 - 110	10	605 00 160110 4		15,5	3	440	220	141	122	144
200 - 110	10	605 00 200110 4		15,5	2	477	235	155	122	155
200 - 160	10	605 00 200160 4		15,5	2	530	255	155	141	155
225 - 110	10	605 00 225110 4		16,5	2	495	250	166	122	167
225 - 160	10	605 00 225160 4		16,5	2	550	270	166	141	167
250 - 110	10	605 00 250110 4		16,5	2	515	265	180	122	182
250 - 160	10	605 00 250160 4		16,5	2	570	285	180	141	182
250 - 200	10	605 00 250200 4		16,5	2	616	315	180	155	182
315 - 110	10	605 00 315110 4		16,5	2	575	312	198	122	197
315 - 160	10	605 00 315160 4		16,5	1	618	318	198	141	197
315 - 200	10	605 00 315200 4		16,5	1	663	344	198	155	197

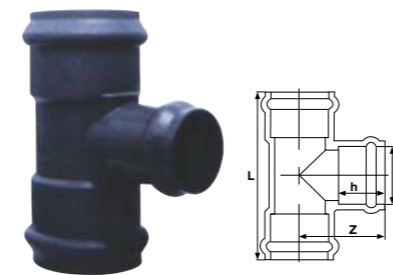
U-PVC 90° Geçme Mufllu Dirsek Te F/F/F
 UH-PVC 90° Tee With Rubber-Ring F/F/F

Çap Dia	Basınç PN	Kod Code	Fiyat (Adet) Price (Pcs)	Kg /Adet Kg/Pcs	Koli/Adet Box/Pcs	L (mm)	h (mm)	Z (mm)
63	10	606 00 063 4		640	30	224	76	112
75	10	606 00 075 4		1,00	12	245	81	122
90	10	606 00 090 4		2,10	8	330	115	165
110	10	606 00 110 4		3,36	5	410	112	206
160	10	606 00 160 4		18,9	3	470	141	238
200	10	606 00 200 4		1,00	2	560	152	280
225	10	606 00 225 4		0,15	2	615	166	308
250	10	606 00 250 4		15,0	2	666	176	333
315	10	606 00 315 4		27,0	1	780	198	390
355	10	606 00 355 4		31,0	1	786	206	393

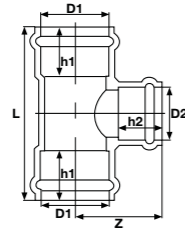
U-PVC 90° Geçme Mufllu İnegal Te F/F/F
 UH-PVC 90° Reducing Tee With Rubber F/F/F

Çap Dia	Basınç PN	Kod Code	Fiyat (Adet) Price (Pcs)	Kg /Adet Kg/Pcs	Koli/Adet Box/Pcs	L (mm)	Z (mm)	h1 (mm)	h2 (mm)
90 - 63	10	607 00 090063 4		1,44	9	304	128	115	76
90 - 75	10	607 00 090075 4			9	304	153	115	81
110 - 63	10	607 00 110063 4		2,42	4	340	141	122	76
110 - 75	10	607 00 110075 4			4	340	138	122	81
110 - 90	10	607 00 110090 4		2,57	4	340	197	122	115
160 - 63	10	607 00 160063 4			4	384	169	141	76
160 - 75	10	607 00 160075 4			4	384	175	141	81
160 - 90	10	607 00 160090 4			4	384	225	141	115
160 - 110	10	607 00 160110 4			3	430	220	142	122
200 - 63	10	607 00 200063 4			2	416	195	152	76
200 - 75	10	607 00 200075 4			2	416	200	152	81
200 - 90	10	607 00 200090 4			2	416	250	152	115
200 - 110	10	607 00 200110 4			2	477	235	155	122
200 - 160	10	607 00 200160 4			2	535	255	155	142
225 - 110	10	607 00 225110 4		24,4	2	492	250	166	122
225 - 160	10	607 00 225160 4		9,9	2	545	270	166	142
250 - 110	10	607 00 250110 4			2	516	265	180	122
250 - 160	10	607 00 250160 4			2	576	285	180	142
250 - 200	10	607 00 250200 4			2	618	315	180	155
315 - 110	10	607 00 315110 4		16,5	1	570	312	198	122
315 - 160	10	607 00 315160 4		17,5	1	618	317	198	142
315 - 200	10	607 00 315200 4			1	658	344	198	155
355 - 160	10	607 00 355160 4		19,5	1	616	343	206	142
355 - 200	10	607 00 355200 4			1	616	387	206	155
355 - 225	10	607 00 355225 4			1	664	370	206	166
355 - 250	10	607 00 355250 4			1	664	413	206	117

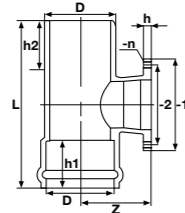
U-PVC 90° Geçme Mufllu Flanş Bağlantılı Te M/F
 UH-PVC 90° Tee With Flange End M/F

Çap Dia	Basınç PN	Kod Code	Fiyat (Adet) Price (Pcs)	Kg /Adet Kg/Pcs	Koli/Adet Box/Pcs	L (mm)	h (mm)	h1 (mm)	h2 (mm)	Q1 (mm)	Q2 (mm)	Z (mm)	Q-n (mm)
110	10	608 00 110 4		0,017	5	410	122	127	21	180	225	225	225
160	10	608 00 160 4		0,020	3	480	141	144	24	240	285	285	285
200	10	608 00 200 4		0,021	2	560	155	155	28	295	340	340	340
225	10	608 00 225 4		0,025	2	615	166	167	30	295	340	340	340

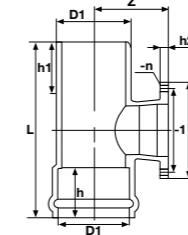
U-PVC 90° Geçme Mufllu Flanş Bağlantılı İnegal Te M/F
 UH-PVC 90° Reducing Tee With Flange End M/F

Çap Dia	Basınç PN	Kod Code	Fiyat (Adet) Price (Pcs)	Kg /Adet Kg/Pcs	Koli/Adet Box/Pcs	L (mm)	h (mm)	h1 (mm)	h2 (mm)	Q1 (mm)	Q2 (mm)	Z (mm)	Q-n (mm)
160 - 110	10	609 00 160110 4		0,02	3	440	141	144	21	180	225	191	17,5x8
200 - 110	10	609 00 200110 4		0,01	2	477	155	155	21	180	225	210	17,5x8
200 - 160	10	609 00 200160 4		0,01	2	530	155	155	24	240	285	216	22x8
225 - 110	10	609 00 225110 4		0,01	2	495	166	167	21	180	225	225	17,5x8
225 - 160	10	609 00 225160 4		0,02	2	550	166	167	24	240	285	230	22x8
250 - 110	10	609 00 250110 4		0,01	2	515	180	182	21	180	225	238	17,5x8
250 - 160	10	609 00 250160 4		0,02	2	570	180	182	24	240	285	240	22x8
250 - 200	10	609 00 250200 4		0,02	2	616	180	180	28	295	240	260	2x8
315 - 110	10	609 00 315110 4		0,01	1	575	198	197	21	180	225	279	17,5x8
315 - 160	10	609 00 315160 4		0,01	1	618	198	197	24	240	285	277	22x8
315 - 200	10	609 00 315200 4		0,02	1	663	198	197	28	295	340	292	2x8

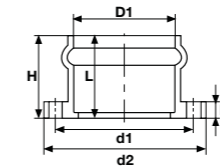
U-PVC Geçme Mufllu Flanş Bağlantılı Manşon F
 UH-PVC 90° Flange Socket With Rubber-Ring F

Çap Dia	Basınç PN	Kod Code	Fiyat (Adet) Price (Pcs)	Kg /Adet Kg/Pcs	Koli/Adet Box/Pcs	D1 (mm)	D2 (mm)	H (mm)	H1 (mm)	L (mm)	Q-n (mm)
63	10	610 00 063 4		0,01	42	125	165	88	16	76	17,5 x 4
75	10	610 00 075 4		0,03	25	145	185	92	16	81	17,5 x 4
90	10	610 00 090 4		1,50	15	160	200	122	20	113	17,5 x 8
110	10	610 00 110 4		1,00	10	180	225	148	21	124	17,5 x 8
160	10	610 00 160 4		2,50	8	240	285	154	24	142	22 x 8
200	10	610 00 200 4		0,01	4	295	336	167	27	153	22 x 8
225	10	610 00 225 4		5,30	2	295	340	173	31	163	22 x 8
250	10	610 00 250 4		7,50	2	350	395	188	33	177	22 x 12
315	10	610 00 315 4		8,50	2	400	445	215	36	199	22 x 12
355	10	610 00 355 4		0,02	2	445-460	505	225	38	209	22 x 16
400	10	610 00 400 4		0,02	2	495-515	565	247	41	227	26 x 16

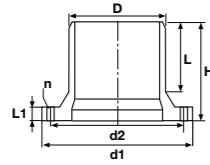
U-PVC Flanlı Adaptör
 UH-PVC 90° Flanged Spigot M

Çap Dia	Basınç PN	Kod Code	Fiyat (Adet) Price (Pcs)	Kg /Adet Kg/Pcs	Koli/Adet Box/Pcs	D1 (mm)	D2 (mm)	H (mm)	L (mm)	L1 (mm)	Q-n (mm)
63	10	611 00 063 4		0,67	42	125	165	110	80	16	17,5 x 4
75	10	611 00 075 4		0,01	25	145	185	130	85	16	17,5 x 4
90	10	611 00 090 4		17,5	15	160	200	153	115	20	17,5 x 8
110	10	611 00 110 4		1,00	10	180	225	167	125	21	17,5 x 8
160	10	611 00 160 4		22,1	8	240	285	196	146	25	22 x 8
200	10	611 00 200 4			4	295	336	215	166	32	22 x 8
225	10	611 00 225 4		17	2	295	340	226	170	31	22 x 8
250	10	611 00 250 4		0,017	2	350	395	257	180	33	22 x 12
315	10	611 00 315 4		18	2	400	445	297	200	36	22 x 12
355	10	611 00 355 4		18	2	445-460	505			38	22 x 16
400	10	611 00 400 4		28,7	2	495-515	565	303	235	41	26 x 16

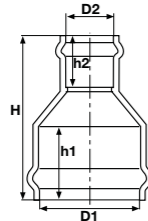
U-PVC Geçme Muflu Redüksiyonlu Manşon F/F
 UH-PVC Reducing Socket With Rubber-Ring F/F

Çap Dia	Basınç PN	Kod Code	Fiyat (Adet) Price (Pcs)	Kg /Adet Kg/Pcs	Koli/Adet Box/Pcs	L (mm)	Z (mm)	h1 (mm)	h2 (mm)
90 - 63	10	612 00 090063 4		0,70	28	304	128	115	76
90 - 75	10	612 00 090075 4		1,00	22	304	153	115	81
110 - 63	10	612 00 110063 4		1,06	18	340	141	122	76
110 - 90	10	612 00 110090 4		1,23	16	340	197	122	115
160 - 110	10	612 00 160110 4		2,00	8	430	220	142	122
200 - 110	10	612 00 200110 4		15,5	4	477	235	155	122
200 - 160	10	612 00 200160 4		1,20	4	535	255	155	142
225 - 110	10	612 00 225110 4			4	492	250	166	122
225 - 160	10	612 00 225160 4			4	545	270	166	142
225 - 200	10	612 00 225200 4			2				
250 - 110	10	612 00 250110 4			4	516	265	180	122
250 - 160	10	612 00 250160 4		5,50	4	576	285	180	142
250 - 200	10	612 00 250200 4		1,60	2	618	315	180	155
250 - 225	10	612 00 250225 4			2				
315 - 110	10	612 00 315110 4			2	570	312	198	122
315 - 160	10	612 00 315160 4			2	618	317	198	142
315 - 200	10	612 00 315200 4			2	658	344	198	155
355 - 160	10	612 00 355160 4			2	616	343	206	142
355 - 200	10	612 00 355200 4		40,0	2	616	387	206	155
355 - 225	10	612 00 355225 4			1	664	370	206	166
355 - 250	10	612 00 355250 4			1	664	413	206	117

UH-PVC

YAPIŞTIRMA MUFLU EK PARÇALAR SOLVENT CEMENT FITTINGS

ÜRETİM STANDARDI
PRODUCTION STANDARD | EN 1452-3

ÇAP / SIZE Ø20 - Ø400

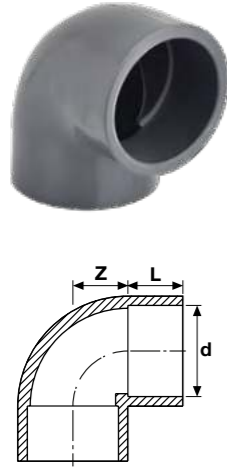

UH-PVC 90° Yapıştırma Muflu Dirsek
 UH-PVC 90° Solvent Cement Elbow

d (mm)	Basınç PN	Kod Code	Fiyat (Adet) Price (Pcs)	Kg /Adet Kg/Pcs	Koli/Adet Box/Pcs	DN	L (mm)	Z (mm)
20	16	500 00 020 2		0,01	400	15	16	11
25	16	500 00 025 2		0,02	200	20	18,5	13,5
32	16	500 00 032 2		0,02	100	25	22	17
40	16	500 00 040 2		0,05	60	32	26	21
50	16	500 00 050 2		0,09	80	40	31	26
63	16	500 00 063 2		0,18	60	50	38	32,5
75	16	500 00 075 2		0,31	40	65	43,5	38,5
90	16	500 00 090 2		0,42	25	80	51	46
110	16	500 00 110 2		0,75	15	100	61	56
125	16	500 00 125 2		1,15	8	110	68,5	63,5
140	16	500 00 140 2		1,53	6	125	76	71
160	16	500 00 160 2		2,25	4	150	86	81
200	16	500 00 200 2		4,65	2	175	106	101
225	10	500 00 225 2		4,83	1	200	118,5	114
250	10	500 00 250 4		6,97	1	250	131	131
280	10	500 00 280 4		8,55	1	250	146	141
315	10	500 00 315 4		12,3	1	300	163,5	163
355	10	500 00 355 4		17,5	1	350	183,5	184
400	10	500 00 400 4		23,5	1	400	206	206

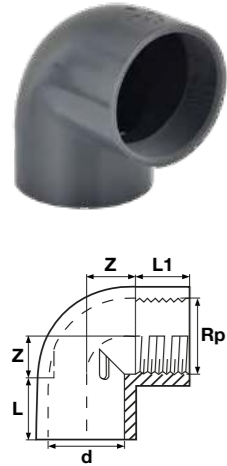
UH-PVC 90° Tek Tarafı İçten Dişli Dirsek
 UH-PVC 90° One Side Female Threaded Elbow

d-Rp Inch	Basınç PN	Kod Code	Fiyat (Adet) Price (Pcs)	Kg /Adet Kg/Pcs	Koli/Adet Box/Pcs	DN	Z (mm)	L (mm)	L1 (mm)
20 x 1/2"	16	500 10 020 2		0,02	303	15	11	16	14
25 x 3/4"	16	500 10 025 2		0,02	200	20	14	18,5	15,5
32 x 1"	16	500 10 032 2		0,04	100	25	17	22	21
40 x 1 1/4"	16	500 10 040 2		0,05	60	32	21	26	23
50 x 1 1/2"	16	500 10 050 2		0,09	80	40	26	31	25
63 x 2"	16	500 10 063 2		0,19	60	50	33	38	29,5
75 x 2 1/2"	16	500 10 075 2		0,41	40	65	38,5	43,5	30
90 x 3"	16	500 10 090 2		0,51	25	80	46	51	33
110 x 4"	16	500 10 110 2		1,00	15	100	56	61	39

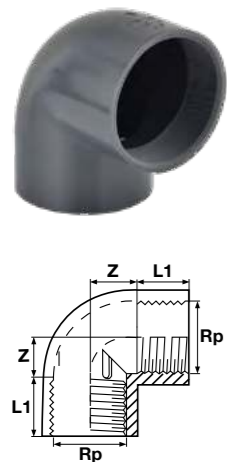
UH-PVC 90° Çift Tarafı İçten Dişli Dirsek
 UH-PVC 90° Both Sides Female Threaded Elbow

Rp Inch	Basınç PN	Kod Code	Fiyat (Adet) Price (Pcs)	Kg /Adet Kg/Pcs	Koli/Adet Box/Pcs	DN	L1 (mm)	Z (mm)
1/2"	16	500 20 020 2		0,02	303	15	14	11
3/4"	16	500 20 025 2		0,02	200	20	16,5	14
1"	16	500 20 032 2		0,04	100	25	21	17
1 1/4"	16	500 20 040 2		0,05	60	32	23	21
1 1/2"	16	500 20 050 2		0,09	80	40	25	26
2"	16	500 20 063 2		0,19	60	50	29,5	33
2 1/2"	16	500 20 075 2		0,42	40	65	30	38,5
3"	16	500 20 090 2		0,55	25	80	33	46
4"	16	500 20 110 2		1,05	15	100	39	56

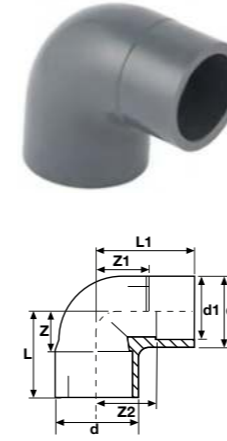
UH-PVC 90° Yapıştırma Muflu Redüksiyonlu Dirsek
 UH-PVC 90° PRO-FIT Elbow

d (mm)	d1 (mm)	Basınç PN	Kod Code	Fiyat (Adet) Price (Pcs)	Kg /Adet Kg/Pcs	Koli/Adet Box/Pcs	L (mm)	L1 (mm)	Z (mm)	Z1 (mm)	Z2 (mm)
50	40	16	501 00 050040 2		0,12	80	57	67	26	36	41
63	50	16	501 00 063050 2		0,23	40	71	83	33	45	52

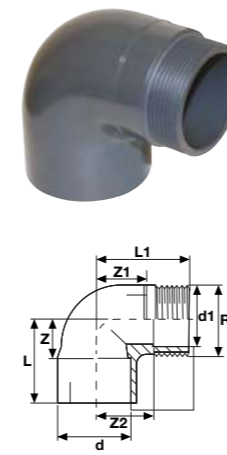
UH-PVC 90° Redüksiyonlu Dış Dış Dirsek
 UH-PVC 90° PRO-FIT Male Threaded Elbow

d (mm)	Rp (Inch)	Basınç PN	Kod Code	Fiyat (Adet) Price (Pcs)	Kg /Adet Kg/Pcs	Koli/Adet Box/Pcs	d1 (mm)	L (mm)	L1 (mm)	Z (mm)	Z1 (mm)	Z2 (mm)
50	1 1/2"	10	501 10 050040 2		1,00	80	40	57	67	26	36	41
63	2"	10	501 10 063050 2		1,00	40	50	71	83	33	45	52

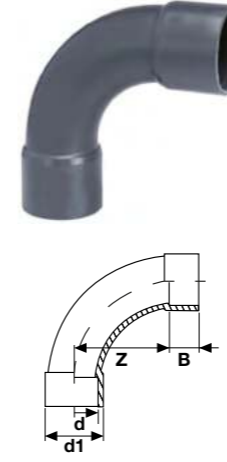
UH-PVC 90° Deve Boynu Dirsek (İç Dış Yapıştırma)
 UH-PVC 90° Solvent Cement Short Bend

d (mm)	Basınç PN	Kod Code	Fiyat (Adet) Price (Pcs)	Kg /Adet Kg/Pcs	Koli/Adet Box/Pcs	d1 (mm)	Z (mm)	B (mm)
50	16	501 00 050050 2		0,27	25	63	100	31
63	16	501 00 063063 2		0,51	20	75	126	38
75	16	501 00 075075 2		0,78	15	90	150	44
90	16	501 00 090090 2		1,33	10	110	180	51
110	16	501 00 110110 2		2,96	5	125	220	61

*U-PVC Borudan Konfeksiyon / U-PVC Hand-made from pipe

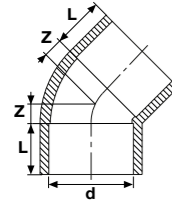
UH-PVC 45° Yapıştırma Muflu Dirsek
 UH-PVC 45° Solvent Cement Elbow

d (mm)	Basınç PN	Kod Code	Fiyat (Adet) Price (Pcs)	Kg /Adet Kg/Pcs	Koli/Adet Box/Pcs	DN (mm)	L (mm)	Z (mm)
20	16	502 00 020 2		0,01	400	15	16	5
25	16	502 00 025 2		0,01	200	20	18,5	6
32	16	502 00 032 2		0,02	100	25	22	7,5
40	16	502 00 040 2		0,04	75	32	26	9,5
50	16	502 00 050 2		0,07	80	40	31	11,5
63	16	502 00 063 2		0,13	50	50	38	14
75	16	502 00 075 2		0,20	40	65	43,5	16,5
90	16	502 00 090 2		0,34	25	80	51	19,5
110	16	502 00 110 2		0,63	18	100	61	24
125	16	502 00 125 2		0,91	8	110	68,5	27
140	16	502 00 140 2		1,35	6	125	76	30
160	16	502 00 160 2		2,00	5	150	86	34
200	10	502 00 200 2		3,7	2	175	106	43
225	10	502 00 225 2		4	2	200	118,5	48
250	10	502 00 250 4		5,47	2	250	131	53
280	10	502 00 280 5		7,51	1	250	146	59
315	10	502 00 315 4		9,2	1	300	163,5	63
355	10	502 00 355 5		9,65	1	350	183,5	67
400	10	502 00 400 4		5	1	400	206	72

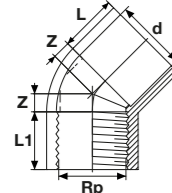
UH-PVC 45° Tek Tarafı İçten Dişli Dirsek
 UH-PVC 45° One Side Female Threaded Elbow

d-Rp Inch	Basınç PN	Kod Code	Fiyat (Adet) Price (Pcs)	Kg /Adet Kg/Pcs	Koli/Adet Box/Pcs	DN (mm)	L (mm)	L1 (mm)	Z (mm)
20 x 1/2"	16	502 10 020 2		0,02	300	15	16	14	5
25 x 3/4"	16	502 10 025 2		0,02	200	20	18,5	16,5	6
32 x 1"	16	502 10 032 2		0,03	100	25	22	21	7,5
40 x 1 1/4"	16	502 10 040 2		0,04	60	32	26	23	9,5
50 x 1 1/2"	16	502 10 050 2		0,08	80	40	31	25	11,5
63 x 2"	16	502 10 063 2		0,14	60	50	38	29,5	14
75 x 2 1/2"	16	502 10 075 2		0,30	40	63	43,5	30	16,5
90 x 3"	16	502 10 090 2		0,43	25	80	51	33	19,5
110 x 4"	16	502 10 110 2		0,88	18	100	61	39	24

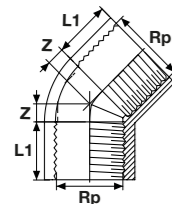
UH-PVC 45° Çift Tarafı İçten Dişli Dirsek
 UH-PVC 45° Both Sides Female Threaded Elbow

Rp Inch	Basınç PN	Kod Code	Fiyat (Adet) Price (Pcs)	Kg /Adet Kg/Pcs	Koli/Adet Box/Pcs	DN (mm)	L1 (mm)	Z (mm)
1/2"	16	502 20 020 2		0,02	300	15	14	5
3/4"	16	502 20 025 2		0,02	200	20	16,5	6
1"	16	502 20 032 2		0,03	100	25	21	7,5
1 1/4"	16	502 20 040 2		0,04	60	32	23	9,5
1 1/2"	16	502 20 050 2		0,09	80	40	25	11,5
2"	16	502 20 063 2		0,15	60	50	29,5	14
2 1/2"	16	502 20 075 2		0,32	40	63	30	16,5
3"	16	502 20 090 2		0,45	25	80	33	19,5
4"	16	502 20 110 2		0,87	18	100	39	24

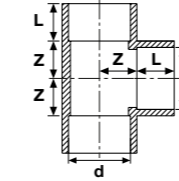
UH-PVC Yapıştırma Muflu Te
 UH-PVC Solvent Cement Tee

d (mm)	Basınç PN	Kod Code	Fiyat (Adet) Price (Pcs)	Kg /Adet Kg/Pcs	Koli/Adet Box/Pcs	DN (mm)	L (mm)	Z (mm)
20	16	504 00 020 2		0,02	200	15	16	11
25	16	504 00 025 2		0,04	100	20	18,5	13,5
32	16	504 00 032 2		0,07	60	25	22	17
40	16	504 00 040 2		0,11	90	32	26	21
50	16	504 00 050 2		0,12	50	40	31	26
63	16	504 00 063 2		0,22	50	50	38	32,5
75	16	504 00 075 2		0,33	30	65	43,5	38,5
90	16	504 00 090 2		0,60	18	80	51	46
110	16	504 00 110 2		1,05	10	100	61	56
125	16	504 00 125 2		2,09	6	110	68,5	63,5
140	16	504 00 140 2		2,18	4	125	76	71
160	16	504 00 160 2		3,30	3	150	86	81
200	16	504 00 200 2		4,57	1	175	106	101
225	10	504 00 225 2		6,50	1	200	118,5	114
250	10	504 00 250 4		8,92	1	250	131	126
280	10	504 00 280 4		11,3	1	250	146	141
315	10	504 00 315 4		16,4	1	300	163,5	159
355	10	504 00 355 4		23,6	1	350	183,5	184
400	10	504 00 400 4		28,1	1	400	206	206

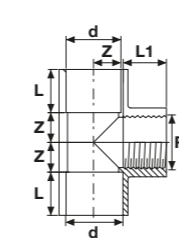
UH-PVC Tek Taraf İçten Dişli Te
 UH-PVC One Side Female Threaded Tee

d Rp (mm) (Inch)	Basınç PN	Kod Code	Fiyat (Adet) Price (Pcs)	Kg /Adet Kg/Pcs	Koli/Adet Box/Pcs	DN (mm)	L1 (mm)	L (mm)	Z (mm)
20 1/2"	16	504 10 020 2		0,02	200	15	14	16	11
25 3/4"	16	504 10 025 2		0,04	100	20	16,5	18,5	14
32 1"	16	504 10 032 2		0,07	60	25	21	22	18
40 1 1/4"	16	504 10 040 2		0,11	90	32	23	26	21
50 1 1/2"	16	504 10 050 2		0,12	50	40	25	31	26
63 2"	16	504 10 063 2		0,22	50	50	29,5	38	32,5
75 2 1/2"	16	504 10 075 2		0,22	30	65	30	43,5	40
90 3"	16	504 10 090 2		0,22	18	80	33	51	46
110 4"	16	504 10 110 2		0,22	10	100	39	61	52

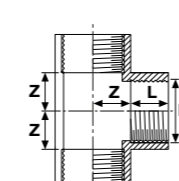
UH-PVC İçten Dişli Te (3 Tarafı)
 UH-PVC Female Threaded Tee (3 Sides)

Rp (Inch)	Basınç PN	Kod Code	Fiyat (Adet) Price (Pcs)	Kg /Adet Kg/Pcs	Koli/Adet Box/Pcs	DN (mm)	L (mm)	Z (mm)
1/2"	16	504 20 020 2		0,02	200	15	14	11
3/4"	16	504 20 025 2		0,04	100	20	16,5	14
1"	16	504 20 032 2		0,07	60	25	21	18
1 1/4"	16	504 20 040 2		0,11	90	32	23	21
1 1/2"	16	504 20 050 2		0,12	50	40	25	26
2"	16	504 20 063 2		0,22	50	50	29,5	32,5
2 1/2"	16	504 20 075 2		0,22	30	65	30	40
3"	16	504 20 090 2		0,22	18	80	33	46
4"	16	504 20 110 2		0,22	10	100	39	52

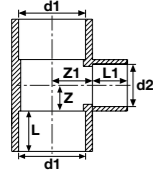
UH-PVC Yapıştırma Muflu İnegal Te
 UH-PVC Solvent Cement Reducing Tee

d1 (mm)	d2 (mm)	Basınç PN	Kod Code	Fiyat (Adet) Price (Pcs)	Kg/Adet Kg/Pcs	Koli/Adet Box/Pcs	DN1 (mm)	DN2 (mm)	L (mm)	L1 (mm)	Z1 (mm)	Z (mm)
32	20	16	508 00 032020 2		0,08	50	25	15	22	16	17	14
32	25	16	508 00 032025 2		0,08	100	25	20	22	16	17	14
32	50	16	508 00 032050 2		0,11	80	25	40	22	16	17	14
40	20	16	508 00 040020 2		0,13	48	32	15	26	16	23	17
40	25	16	508 00 040025 2		0,13	48	32	20	26	18,5	23	17
40	32	16	508 00 040032 2		0,13	48	32	25	26	22	23	17
50	20	16	508 00 050020 2		0,14	75	40	15	31	16	28	17
50	25	16	508 00 050025 2		0,14	75	40	20	31	18,5	28	17
50	32	16	508 00 050032 2		0,14	75	40	25	31	18,5	28	17
50	40	16	508 00 050040 2		0,14	50	40	32	31	22	28	17
63	25	16	508 00 063025 2		0,24	40	40	15	38	26	28	23
63	32	16	508 00 063032 2		0,24	30	50	25	38	18,5	35	23
63	40	16	508 00 063040 2		0,25	30	50	32	38	22	35	23
63	50	16	508 00 063050 2		0,29	30	50	40	38	26	35	23
75	32	16	508 00 075032 2			30	65	25	43,5	22	38,5	17
*75	40	16	508 00 075040 2			30	65	32	43,5	26	38,5	23
*75	50	16	508 00 075050 2			30	65	40	43,5	31	38,5	28
75	63	16	508 00 075063 2		0,45	30	65	50	43,5	31	38,5	28
*90	32	16	508 00 090032 2			35	80	25	51	22	46	17
*90	40	16	508 00 090040 2			35	80	32	51	26	46	23
*90	50	16	508 00 090050 2			35	80	40	51	31	46	28
90	63	16	508 00 090063 2		0,64	35	80	50	51	38	46	35
90	75	16	508 00 090075 2		0,66	25	80	65	51	38	46	35
*110	32	16	508 00 110032 2			22	100	25	61	22	56	17
*110	40	16	508 00 110040 2			22	100	32	61	26	56	23
110	50	16	508 00 110050 2			22	100	40	61	31	56	28
110	63	16	508 00 110063 2		0,75	22	100	50	61	43,5	56	40
110	75	16	508 00 110075 2		0,93	10	100	65	61	38	56	35
110	90	16	508 00 110090 2		0,98	11	100	80	61	43,5	56	40
125	63	16	508 00 125063 2		1,26	10	110	50	68,5	51	64	46
*125	75	16	508 00 125075 2		1,71	10	110	65	68,5	38	64	35
125	90	16	508 00 125090 2		1,58	8	110	80	68,5	43,5	64	40
125	110	16	508 00 125110 2		1,59	8	110	100	68,5	51	64	46
*140	63	16	508 00 140063 2		2,53	8	125	50	76	61	72	56
*140	75	16	508 00 140075 2		2,54	6	125	65	76	38	72	35
*140	90	16	508 00 140090 2		2,53	6	125	80	76	43,5	72	40
140	110	16	508 00 140110 2		2,27	6	125	100	76	51	72	46
*160	63	16	508 00 160063 2		2,69	5	150	50	86	61	81	56
*160	75	16	508 00 160075 2		2,70	5	150	65	86	38	81	35
*160	90	16	508 00 160090 2		2,69	5	150	80	86	43,5	81	40
160	110	16	508 00 160110 2		2,43	5	150	100	86	51	81	46
*160	125	16	508 00 160125 2		4,15	5	150	110	86	61	81	56
*200	75	16	508 00 200075 2		4,30	2	175	65	106	68,5	107	69
*200	90	16	508 00 200090 2		4,29	2	175	80	106	43,5	107	40
200	110	16	508 00 200110 2		4,03	2	175	100	106	51	107	46
*200	125	16	508 00 200125 2		5,25	2	175	110	106	61	107	82
*200	140	16	508 00 200140 2		4,96	2	175	125	106	68,5	107	82
200	160	16	508 00 200160 2		4,40	2	175	150	106	76	107	82
225	110	16	508 00 225110 2		4,32	2	200	100	118,5	86	120	82
*225	125	16	508 00 225125 2		5,43	2	200	110	118,5	61	120	56
*225	140	16	508 00 225140 2		5,14	2	200	125	118,5	68,5	120	69
225	160	16	508 00 225160 2		4,58	2	200	150	118,5	76	120	72
*225	200	10	508 00 225200 2		4,80	2	200	175	118,5	86	120	82
250	110	10	508 00 250110 2		7,75	1	250	100	131	106	132	107
*250	140	10	508 00 250140 2		7,85	1	250	125	131	61	132	132
250	160	10	508 00 250160 2		7,95	1	250	150	131	76	132	132
250	200	10	508 00 250200 2		8,15	1	250	175	131	86	132	132
*250	225	10	508 00 250225 2		10,56	1	250	200	131	106	132	132
280	110	10	508 00 280110 5			1	215	100	146	118,5	146	132
*280	140	10	508 00 280140 5			1	250	125	146	61	146	146
280	160	10	508 00 280160 5			1	250	150	146	76	146	146
*280	200	10	508 00 280200 5			1	250	175	146	86	146	146
280	225	10	508 00 280225 5			1	250	200	146	106	146	146
*280	250	10	508 00 280250 5			1	250	250	146	118,5	146	146
315	110	10	508 00 315110 5		14,2	1	300	100	146	131	146	146
315	160	10	508 00 315160 2		13,5	1	300	150	163,5	61	168	168
315	225	10	508 00 315225 2		14,1	1	300	200	163,5	86	168	168
*315	250	10	508 00 315250 2		22,3	1	300	250	163,5	118,5	168	168
*315	280	10	508 00 315280 2		19,9	1	300	250	163,5	131	168	168
*355	280	10	508 00 355280 5		33,5	1	350	250	163,5	146	168	168
*355	315	10	508 00 355315 5		30,1	1	350	300	183,5	146	196	152
*400	280	10	508 00 400280 5		46,5	1	400	250	183,5	163,5	196	175
*400	315	10	508 00 400315 5		43,0	1	400	300	206	146	214	152
*400	355	10	508 00 400355 5		36,6	1	400	350	206	163,5	214	175

*Redüksiyon ile düşürülmüştür/Reduced with reducer.

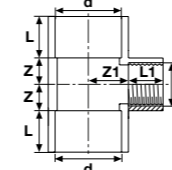
UH-PVC Tek Taraf İçten Dişli İnegal Te
 UH-PVC One Side Female Threaded Reducing Tee

d (mm)	Rp (Inch)	Basınç PN	Kod Code	Fiyat (Adet) Price (Pcs)	Kg /Adet Kg/Pcs	Koli/Adet Box/Pcs	DN (mm)	L (mm)	L1 (mm)	Z1 (mm)	Z (mm)
50	1"	16	508 10 050032 2		0,14	75	40	31	21	18	26
63	1"	16	508 10 063032 2		0,24	40	50	38	21	18	32,5
63	1 1/2"	16	508 10 063050 2		0,29	30	50	38	25	26	32,5
75	2"	16	508 10 075063 2		0,47	35	65	44	29,5	26	40
90	2"	16	508 10 090063 2		0,66	25	75	51	29,5	32,5	46
90	2 1/2"	16	508 10 090075 2		0,68	22	75	51	30	32,5	46
110	2"	16	508 10 110063 2		0,77	10	100	61	29,5	40	52
110	2 1/2"	16	508 10 110075 2		0,95	11	100	61	30	32,5	52
110	3"	16	508 10 110090 2		1,00	10	100	61	33	56	52

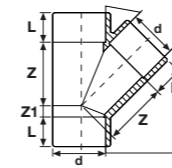
UH-PVC 45° Yapıştırma Muflu Te (Çatal)
 UH-PVC 45° Solvent Single Branch Tee

d (mm)	Basınç PN	Kod Code	Fiyat (Adet) Price (Pcs)	Kg /Adet Kg/Pcs	Koli/Adet Box/Pcs	Z (mm)	Z1 (mm)	L (mm)
*20	16	507 00 020 4				27	6	16
*25	16	507 00 025 4				33	7	18,5
*32	16	507 00 032 4				42	8	22
*40	16	507 00 040 4				51	10	26
50	16	507 00 050 4		0,12	20	53	12	31
63	16	507 00 063 4		0,23	20	79	14	38
*75	16	507 00 075 4			25	94	17	43,5
*90	16	507 00 090 4			20	122	20	51
110	16	507 00 110 4		1,41	8	137	24	61

*U-PVC Borudan Konfeksiyon / U-PVC Hand-made from pipe

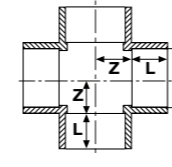
UH-PVC 90° Yapıştırma Muflu Kruva (İstavroz)
 UH-PVC 90° Solvent Cement Cross

d (mm)	Basınç PN	Kod Code	Fiyat (Adet) Price (Pcs)	Kg /Adet Kg/Pcs	Koli/Adet Box/Pcs	DN	L (mm)	Z (mm)
32	16	506 00 032 2		0,09	110	25	22	17
40	16	506 00 040 2		0,14	70	32	26	21
50	16	506 00 050 2		0,22	35	40	31	26
63	16	506 00 063 2		0,37	40	50	38	32,5
75	16	506 00 075 2		0,55	20	65	43,5	38,5
90	16	506 00 090 2		0,96	12	80	51	46
110	16	506 00 110 2		1,62	7	100	61	56
125	16	506 00 125 2		2,35	4	110	68,5	63,5
*140	16	506 00 140 5		2,52	4	125	76	71
160	16	506 00 160 5		3,95	3	150	86	81
200	16	506 00 200 5		5,02	1	175	10	

UH-PVC Yapıştırma Muflu Manşon
 UH-PVC Double Socket

d (mm)	Basınç PN	Kod Code	Fiyat (Adet) Price (Pcs)	Kg /Adet Kg/Pcs	Koli/Adet Box/Pcs	DN	L (mm)	Z (mm)
16	16	511 00 016 2		0,01	500	12	14	3
20	16	511 00 020 2		0,01	480	15	16	3
25	16	511 00 025 2		0,02	250	20	18,5	3
32	16	511 00 032 2		0,01	125	25	22	3
40	16	511 00 040 2		0,03	140	32	26	3
50	16	511 00 050 2		0,06	70	40	31	3
63	16	511 00 063 2		0,11	120	50	38	3
75	16	511 00 075 2		0,17	90	65	43,5	4
90	16	511 00 090 2		0,30	40	80	51	5
110	16	511 00 110 2		0,48	28	100	61	6
125	16	511 00 125 2		0,7	22	110	68,5	6
140	16	511 00 140 2		0,9	16	125	76	8
160	16	511 00 160 2		1,3	12	150	86	8
200	16	511 00 200 2		2,15	3	175	106	8
225	16	511 00 225 2		3,79	2	200	118,5	10
250	10	511 00 250 4		4	1	250	131	12
280	10	511 00 280 5		7,6	1	250	146	12
315	10	511 00 315 5		6,98	1	300	163,5	14
355	10	511 00 355 5		13,9	1	350	183,5	68
400	10	511 00 400 5		11,6	1	400	206	73

UH-PVC Tek Taraf İçten Dişli Redüksiyonlu Adaptör
 UH-PVC One Side Female Threaded Reducer Adaptor

d (mm)	Rp (Inch)	Basınç PN	Kod Code	Fiyat (Adet) Price (Pcs)	Kg /Adet Kg/Pcs	Koli/Adet Box/Pcs	D (mm)	L (mm)	L1 (mm)	Z (mm)
20	1/2"	16	518 00 020 2		0,01	450	25	12	16	5,5
25	3/4"	16	518 00 025 2		0,02	240	32	16	22	1,5
32	1"	16	518 00 032 2		0,03	180	40	19	27	1,5
40	1 1/4"	16	518 00 040 2		0,06	80	50	22	27	5
50	1 1/2"	16	518 00 050 2		0,13	100	63	19	38	9,5
63	2"	16	518 00 063 2		0,17	75	75	24	39	6

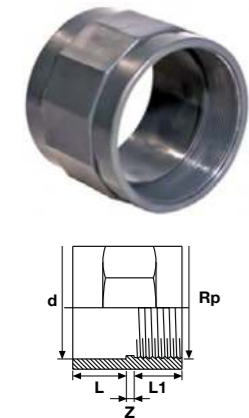

d (mm)	Rp (Inch)	Basınç PN	Kod Code	Fiyat (Adet) Price (Pcs)	Kg /Adet Kg/Pcs	Koli/Adet Box/Pcs	L (mm)	L1 (mm)	Z (mm)
75	2 1/2"	16	519 00 075 2		0,24	75	44	32	7
90	3"	16	519 00 090 2		0,31	60	52	36	9
110	4"	16	519 00 110 2		0,47	18	61	40	9
125	4 1/2"	16	519 00 125 5		0,86	22	69	44	40
140	5"	16	519 00 140 5		1,06	16	75	44	40
160	6"	10	519 00 160 5		1,56	12	86	50	50
*200	7"	10	519 00 200 5		2,34	4	106	55	50
*225	8"	10	519 00 225 5		3,09	2	120	60	55
*250	9"	10	519 00 250 5		3,90	2	131	60	55

*Konfeksiyon / Hand-made

UH-PVC Çift Tarafı İçten Dişli Redüksiyonlu Adaptör
 UH-PVC Both Sides Female Threaded Reducer Adaptor

d (mm)	R1-R2 (inch)	Basınç PN	Kod Code	Fiyat (Adet) Price (Pcs)	Kg /Adet Kg/Pcs	Koli/Adet Box/Pcs	L (mm)	Z (mm)
25	1/2"	16	518 10 020 2		0,01	450	12	5,5
32	3/4"	16	518 10 025 2		0,02	240	16	1,5
40	1"	16	518 10 032 2		0,03	180	19	1,5
50	1 1/4"	16	518 10 040 2		0,06	80	22	5
*63	1 1/2"	16	518 10 050 2		0,15	100	19	9,5
*75	2"	16	518 10 063 2		0,15	75	24	6

*Konfeksiyon / Hand-made

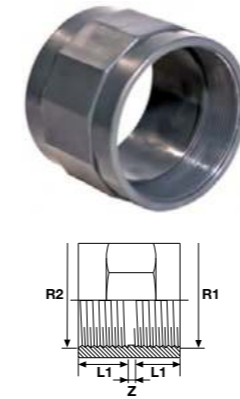

R1 (inch)	R2 (inch)	Basınç PN	Kod Code	Fiyat (Adet) Price (Pcs)	Kg /Adet Kg/Pcs	Koli/Adet Box/Pcs	L1 (mm)	Z (mm)
75	2 1/2"	16	519 10 075 2			75	32	7
90	3"	16	519 10 090 2			60	36	9
110	4"	16	519 10 110 2			18	40	9

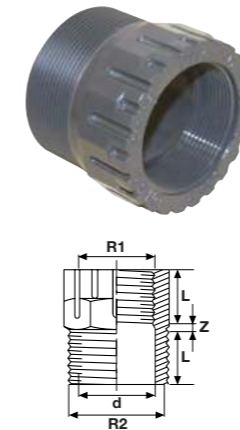
UH-PVC Tek Taraf Dış Diş Tek Taraf İç Diş Redüksiyonlu Adaptör
 UH-PVC One Side Female Other Side Male Threaded Adaptor

R1 Inch	R2 Inch	Basınç PN	Kod Code	Fiyat (Adet) Price (Pcs)	Kg /Adet Kg/Pcs	Koli/Adet Box/Pcs	L (mm)	Z (mm)
1 1/4"	1 1/2"	16	518 20 040 2		0,04	80	22	5
1 1/2"	1 1/2"	16	518 20 050 2		0,07	150	19	9,5
*2 1/2"	2"	16	508 20 050 2		0,09	95	19	9,5
*2"	2"	16	518 20 063 2		0,10	160	24	6
2"	2 1/2"	16	518 20 063 3		0,14	75	24	6
2 1/2"	3"	16	518 20 075 2			75	32	7
4"	4 1/2"	16	518 20 110 2			18	36	9

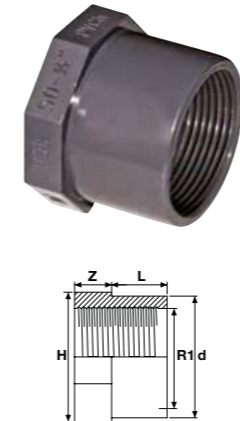
UH-PVC Dış Y.M. İç Diş Redüksiyonlu Adaptör
 UH-PVC One Side Female Threaded Reducer Adaptor

d (mm)	R1 Inch	Basınç PN	Kod Code	Fiyat (Adet) Price (Pcs)	Kg /Adet Kg/Pcs	Koli/Adet Box/Pcs	L (mm)	Z (mm)	H (mm)
32	3/4"	16	518 20 025 2		0,01	550	12	8	28
40	1"	16	518 20 032 2		0,01	250	14,4	9	35
50	1 1/4"	16	518 21 040 2		0,02	180	16,8	9	44
63	2"	16	518 20 063 2		0,06	120	21,1	12	68

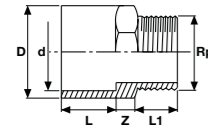
UH-PVC Tek Taraf Dıştan Dişli Redüksiyonlu Adaptör
 UH-PVC One Side Male Threaded Reducer Adaptor

d (mm)	Rp Inch	Basınç PN	Kod Code	Fiyat (Adet) Price (Pcs)	Kg /Adet Kg/Pcs	Koli/Adet Box/Pcs	D (mm)	L (mm)	L1 (mm)	Z (mm)
20	1/2"	16	522 00 020 2		0,01	400	25	16	15	10
25	3/4"	16	522 00 025 0		0,02	250	32	19	16	11
32	1"	16	522 00 032 2		0,03	160	40	22	19	11
40	1 1/4"	16	522 00 040 2		0,06	120	50	26	21	14
50	1 1/2"	16	522 00 050 2		0,10	150	63	31	22	8
63	2"	16	522 00 063 2		0,16	100	75	38	27	9
75	2 1/2"	16	522 00 075 2		0,24	48	90	44	30	16
90	3"	16	522 00 090 2		0,44	27	110	51	33	20
110	4"	16	522 00 110 2		0,47	26	125	61	39	19

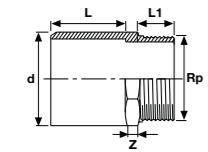
UH-PVC Dış Dişli Dıştan Yapıştırılabilir Adaptör (Uzun Tip)
 UH-PVC Male Threaded Adaptor (Long Type)

d (mm)	Rp Inch	Basınç PN	Kod Code	Fiyat (Adet) Price (Pcs)	Kg /Adet Kg/Pcs	Koli/Adet Box/Pcs	L (mm)	L1 (mm)	Z (mm)
50	1/2"	16	524 00 050 2		0,09	125	60,0	22,0	14
63	2"	16	524 00 063 2		0,14	70	70,0	30,0	15
75	2 1/2"	16	524 00 075 2		0,22	80	87,0	30,0	15
90	3"	16	524 00 090 2		0,37	40	108,0	35,0	15
110	4"	16	524 00 110 2		0,45	30	94,0	40,0	30
* 125	4 1/2"	16	524 00 125 2		1,02	14	126,0	44,0	40
* 140	5"	16	524 00 140 2		0,95	12	126,0	44,0	40
* 160	6"	16	524 00 160 2		1,14	8	111,0	50,0	50
* 200	7"	10	524 00 200 2		1,65	6	172,0	80,0	50

*Konfeksiyon / Hand-made

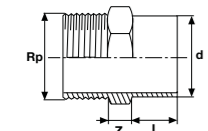
UH-PVC Yapıştırma Muflu Dış Dişli Adaptör
 UH-PVC Male Threaded Adaptor Solvent Cemented

d (mm)	Rp Inch	Basınç PN	Kod Code	Fiyat (Adet) Price (Pcs)	Kg /Adet Kg/Pcs	Koli/Adet Box/Pcs	L (mm)	Z (mm)
50	1 1/2"	16	521 00 050 2		0,11	150	22	14
63	2"	16	521 00 063 2		0,12	140	27	15

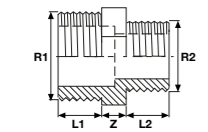
UH-PVC Çift Taraf Dış Diş Redüksiyonlu Adaptör
 UH-PVC Both Sides Male Threaded Reducer Adaptor

R1 Inch	R2 Inch	Basınç PN	Kod Code	Fiyat (Adet) Price (Pcs)	Kg /Adet Kg/Pcs	Koli/Adet Box/Pcs	L1 (mm)	L2 (mm)	Z (mm)
3/4"	1/2"	16	522 10 020 2		0,01	500	13	12	8
1"	3/4"	16	522 10 025 2		0,01	300	14	13	8
1 1/4"	1"	16	522 10 032 2		0,02	179	16	14	9
1 1/2"	1"	16	522 10 032 2		0,03	150	17	14	9
1 1/2"	1 1/4"	16	522 10 040 2		0,08	149	17	16	9
2"	1"	16	522 11 032 2		0,12	70	23	21	12
2"	1 1/4"	16	522 11 040 2		0,16	105	23	16	12
2"	1 1/2"	16	522 10 050 2		0,27	70	23	17	12
2 1/2"	1 1/4"	16	522 11 050 2		0,08	75	24	17	12
2 1/2"	2"	16	522 10 063 2		0,08	105	24	21	12
3"	2"	16	522 11 063 2		0,12	35	26	21	14
3"	2 1/2"	16	522 10 075 2		0,27	48	26	24	14
4"	2 1/2"	16	522 12 075 2		0,16	35	32	24	16
4"	2"	16	522 12 063 2		0,27	35	32	21	16
4"	3"	16	522 10 090 2		0,03	45	32	26	16

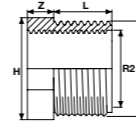
UH-PVC Tek Taraf Dış Diş Tek Taraf İç Diş Redüksiyonlu Adaptör
 UH-PVC One Side Female Other Side Male Threaded Reducer Adaptor

R1 Inch	R2 Inch	Basınç PN	Kod Code	Fiyat (Adet) Price (Pcs)	Kg /Adet Kg/Pcs	Koli/Adet Box/Pcs	L (mm)	Z (mm)	H (mm)
25	1/2"	16	518 20 040 3		0,01	550	12	8	28
32	3/4"	16	518 20 050 3		0,01	250	14,4	9	35
40	1"	16	518 21 050 3		0,02	180	16,8	9	44
63	3 1/2"	16	518 20 063 3		0,06	120	21,1	12	64

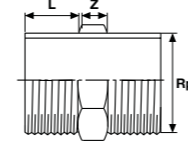
UH-PVC Nipel
 UH-PVC Barrel Nipel

Rp Inch	Basınç PN	Kod Code	Fiyat (Adet) Price (Pcs)	Kg /Adet Kg/Pcs	Koli/Adet Box/Pcs	L (mm)	Z (mm)
1/2"	16	520 00 020 2		0,08	800	16,0	8,0
3/4"	16	520 00 025 2		0,11	500	18,0	10,0
1"	16	520 00 032 2		0,18	250	22,0	12,0
1 1/4"	16	520 00 040 2		0,32	180	23	14
1 1/2"	16	520 00 050 2		0,43	150	26	14
2"	16	520 00 063 2		0,083	120	21	12
2 1/2"	16	520 00 075 2		0,124	75	24	12
3"	16	520 00 090 2		0,171	70	26	14
4"	16	520 00 110 2		0,278	45	32	16
4 1/2"	16	520 00 125 5		0,626	20	44,0	40,0
5"	16	520 00 140 5		0,752	10	44,0	50,0
6"	16	520 00 160 5		1,6	10	50,0	50,0
7"	10	520 00 200 5		1,955	4	55,0	50,0

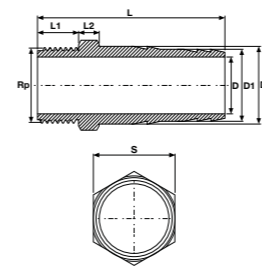
UH-PVC Dış Dişli Hortum Adaptörü
 UH-PVC One Side Male Threaded Hose Adaptor

d (mm)	Basınç PN	Kod Code	Fiyat (Adet) Price (Pcs)	Kg /Adet Kg/Pcs	Koli/Adet Box/Pcs	Rp (mm)	D (mm)	D1 (mm)	D2 (mm)	L (mm)	L1 (mm)	L2 (mm)	S (mm)
20	16	525 00 020 2		0,01	400	1/2"	15	20,4	22	62	15	8	22
25	16	525 00 025 2		0,03	225	3/4"	20	25,4	28	72	16	8	28
32	16	525 00 032 2		0,04	140	1"	25	31,4	34	82	18	9	34
40	16	525 00 040 2		0,05	150	1 1/4"	32	40,4	43	95	21	13	43
50	16	525 00 050 2		0,08	125	1 1/2"	40	50	53	104	21	14	53
63	16	525 00 063 2		0,14	70	2"	50	60	66	123	26	16	66
75	16	525 00 075 2		0,21	80	2 1/2"				132	30		
90	16	525 00 090 2		0,35	40	3"				158	35		
*110	16	525 00 110 2		0,40	30	4"				164	40		
*125	16	525 00 125 5			20	4 1/2"				210	43		
*140	16	525 00 140 5			12	5"				210	43		
*160	16	525 00 160 5		1,22	8	6"				211	45		

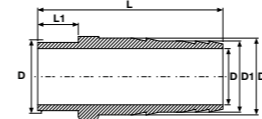
UH-PVC Dıştan Yapıştırılabilir Hortum Adaptörü
 UH-Pvc Solvent Cement Hose Adaptor (External Connection)

d (mm)	Basınç PN	Kod Code	Fiyat (Adet) Price (Pcs)	Kg /Adet Kg/Pcs	Koli/Adet Box/Pcs	Rp (mm)	D (mm)	D1 (mm)	D2 (mm)	L (mm)	L1 (mm)
20	16	528 80 020 2		0,01	400	1/2"	20	20	22	55	16
25	16	528 80 025 2		0,03	225	3/4"	25	25	28	67	19
32	16	528 80 032 2		0,04	140	1"	32	31	34	77	22
40	16	528 80 040 2		0,05	150	1 1/4"	40	40	43	87	26
50	16	528 80 050 2		0,08	125	1 1/2"	50	50	53	100	31
63	16	528 80 063 2		0,14	70	2"	63	60	66	119	38

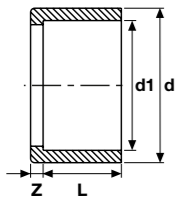
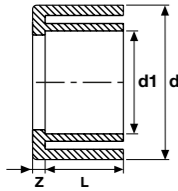
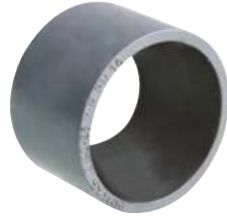
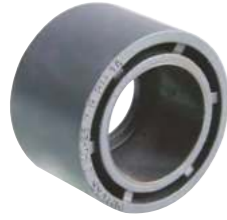
UH-PVC Yapıştırma Muflu Redüksiyon
 UH-PVC Solvent Cement Reducer

d (mm)	d1 (mm)	Basınç PN	Kod Code	Fiyat (Adet) Price (Pcs)	Kg /Adet Kg/Pcs	Koli/Adet Box/Pcs	L (mm)	Z (mm)
20	16	16	509 00 020016 2		0,004	1500	14	2
25	20	16	509 00 025020 2		0,004	1000	16	3
32	20	16	509 00 032020 2		0,01	500	16	7
32	25	16	509 00 032025 2		0,01	500	18,5	4
40	20	16	509 00 040020 2		0,02	300	16	10
40	25	16	509 00 040025 2		0,02	300	18,5	7
40	32	16	509 00 040032 2		0,01	300	22	4
50	32	16	509 00 050032 2		0,03	200	22	9
50	40	16	509 00 050040 2		0,02	200	26	5
63	32	16	509 00 063032 2		0,07	100	22	16
63	40	16	509 00 063040 2		0,07	100	26	11
63	50	16	509 00 063050 2		0,05	100	31	6,5
75	40	16	509 00 075040 2		0,08	60	26	17,5
75	50	16	509 00 075050 2		0,09	60	31	13
75	63	16	509 00 075063 2		0,07	60	38	6
90	32	16	509 00 090032 2		0,13	65	22	25
90	50	16	509 00 090050 2		0,14	70	31	20
90	63	16	509 00 090063 2		0,14	70	38	13
90	75	16	509 00 090075 2		0,13	70	43,5	8
110	50	16	509 00 110050 2		0,25		31	30
110	63	16	509 00 110063 2		0,26	40	38	23
110	75	16	509 00 110075 2		0,27	40	44	17
110	90	16	509 00 110090 2		0,26	40	51	10
125	63	16	509 00 125063 2		0,40	25	38	31
125	75	16	509 00 125075 2		0,42	25	43,5	25
125	90	16	509 00 125090 2		0,38	25	51	18
125	110	16	509 00 125110 2		0,25	25	61	7,5
140	63	16	509 00 140063 2		0,525	35	38	40
140	75	16	509 00 140075 2		0,5	35	43,5	33
140	90	16	509 00 140090 2		0,49	35	51	25
140	110	16	509 00 140110 2		0,50	33	61	15
140	125	16	509 00 140125 2		0,294	25	68,5	7,5
160	90	16	509 00 160090 2		0,70	12	51	35
160	110	16	509 00 160110 2		0,76	15	61	25
160	140	16	509 00 160140 2		0,56	15	76	10
200	160	16	509 00 200160 2		1,22	12	86	20
225	200	16	509 00 225200 2		1,34	6	106	13
*250	200	16	509 00 250200 2		2,98	6	106	25,5
250	225	16	509 00 250225 2		1,64	6	118,5	12,5
280	250	16	509 00 280250 2		2,43	2	131	16
315	280	16	509 00 315280 2		3,54	2	146	17
*355	280	16	509 00 355 280 5		10,40	1	146	44
355	315	16	509 00 355315 5		6,41	1	163,5	27
*400	280	16	509 00 400280 5		18,9	1	146	67
*400	315	16	509 00 400315 5		14,9	1	163,5	50
400	355	16	509 00 400355 5		8,53	1	183,5	23

*Redüksiyon ile düşürülmüştür. / Reduced with reducer.

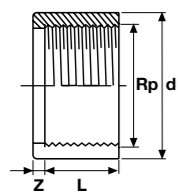
UH-PVC İçten Dişli Redüksiyon
 UH-PVC Female Threaded Reducer

d (mm)	Rp Inch	Basınç PN	Kod Code	Fiyat (Adet) Price (Pcs)	Kg /Adet Kg/Pcs	Koli/Adet Box/Pcs	L (mm)	Z (mm)
25	1/2"	16	509 10 025020 2		0,004	1200	16	3
32	1/2"	16	509 10 032020 2		0,01	600	16	7
40	3/4"	16	509 10 040025 2		0,02	300	20	7
40	1"	16	509 10 040032 2		0,01	300	20	6
50	1"	16	509 10 050032 2		0,03	200	25	6
50	1 1/4"	16	509 10 050040 2		0,02	200	23	9
63	1"	16	509 10 063032 2		0,07	100	22	16
63	1 1/2"	16	509 10 063050 2		0,05	100	30	8
75	1 1/2"	16	509 10 075050 2		0,09	30	31	13
75	2"	16	509 10 075063 2		0,07	30	36	8
90	2"	16	509 10 090063 2		0,14	65	38	13
90	2 1/2"	16	509 10 090075 2		0,13	65	43	8
110	2"	16	509 10 110063 2		0,26	75	38	23
110	2 1/2"	16	509 10 110075 2		0,27	75	44	17
110	3"	16	509 10 110090 2		0,26	75	50	10

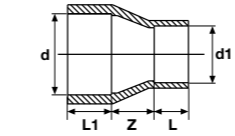
UH-PVC Yapıştırma Muflu Konik Redüksiyon
 UH-PVC Solvent Cement Conical Reducer

d (mm)	d1 (mm)	Basınç PN	Kod Code	Fiyat (Adet) Price (Pcs)	Kg /Adet Kg/Pcs	Koli/Adet Box/Pcs	Z (mm)	L (mm)	L1 (mm)
160	110	16	510 00 160110 2		1,27	12	40	61	86
225	110	16	510 00 225110 2		2,64	3	41,5	61	118,5
225	160	16	510 00 225160 2		2,66	3	41,5	86	118,5
400	250	16	510 00 400250 2		10,5	1	50	131	206
400	355	16	510 00 400355 2		11,5	1	51	183,5	206

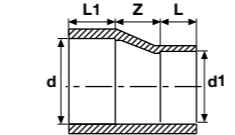
UH-PVC Yapıştırma Muflu Eksantrik Redüksiyon
 UH-PVC Solvent Cement Excentric Reducer

d (mm)	d1 (mm)	Basınç PN	Kod Code	Fiyat (Adet) Price (Pcs)	Kg /Adet Kg/Pcs	Koli/Adet Box/Pcs	Z (mm)	L (mm)	L1 (mm)
250	200	16	510 00 250 200 2		3,37	2	37,8	106,5	131
250	225	16	510 00 250 225 2		3,38	2	24,5	119,5	131

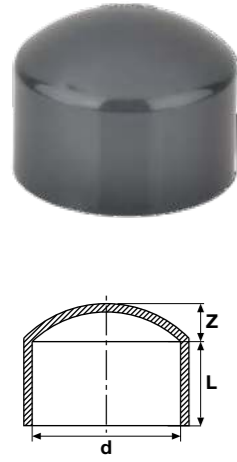

UH-PVC Yapıştırma Muflu Kör Tapa
 UH-PVC Solvent Cement End Cap

d (mm)	Basınç PN	Kod Code	Fiyat (Adet) Price (Pcs)	Kg /Adet Kg/Pcs	Koli/Adet Box/Pcs	DN	L (mm)	Z (mm)
20	16	516 00 020 2		0,008	700	15	16	5,5
25	16	516 00 025 2		0,01	600	20	18,5	7
32	16	516 00 032 2		0,02	350	25	22	8,5
40	16	516 00 040 2		0,04	250	32	26	10
50	16	516 00 050 2		0,05	100	40	31	12
63	16	516 00 063 2		0,08	100	50	38	16
75	16	516 00 075 2		0,17	60	65	43,5	18
90	16	516 00 090 2		0,34	35	80	51	20
110	16	516 00 110 2		0,34	25	100	61	24
125	16	516 00 125 2		0,46	15	110	68,5	26
140	16	516 00 140 2		0,82	10	125	76	30
160	16	516 00 160 2		1,16	8	150	86	38
200	16	516 00 200 2		1,46	8	175	106	44
225	16	516 00 225 2		2,31	6	200	118,5	50
250	10	516 00 250 2		2,87	2	250	131	55
280	10	516 00 280 2		4,81	2	250	146	60
315	10	516 00 315 2		5,87	1	300	163,5	64
355	10	516 00 355 4		9,30	1	350	183,5	67
400	10	516 00 400 4		16,2	1	400	206	71
*450	10	516 00 450 5		-	1	-	-	-
*500	10	516 00 500 5		-	1	-	-	-

UH-PVC İçten Dişli Kör Tapa
 UH-PVC Female Threaded Cap

d (mm)	Rp Inch	Basınç PN	Kod Code	Fiyat (Adet) Price (Pcs)	Kg /Adet Kg/Pcs	Koli/Adet Box/Pcs	L (mm)	D (mm)
20	1/2"	16	517 00 020 2		0,01	700	19,5	26
25	3/4"	16	517 00 025 2		0,08	600	20,5	31
32	1"	16	517 00 032 2		0,024	250	24	39
40	1 1/4"	16	517 00 040 2		0,027	150	26,5	51
50	1 1/2"	16	517 00 050 2		0,082	210	27	56
63	2"	16	517 00 063 2		0,067	100	33,5	70
75	2 1/2"	16	517 00 075 2		0,23	60	40	88
90	3"	16	517 00 090 2		0,2	35	44	102
110	4"	16	517 00 110 2		0,29	25	50	128

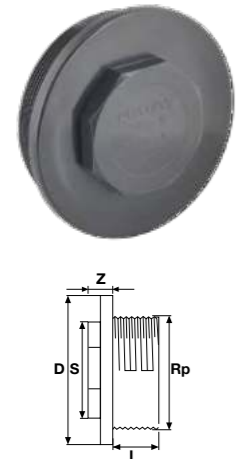
UH-PVC Dıştan Dişli Kör Tapa
 UH-PVC Solvent Cement Threaded Plug

Rp Inch	Basınç PN	Kod Code	Fiyat (Adet) Price (Pcs)	Kg /Adet Kg/Pcs	Koli/Adet Box/Pcs	D (mm)	L (mm)	Z (mm)	S (mm)
2"	16	523 00 063 2		0,06	100	75	31	12	65
2 1/2"	16	523 00 075 2		0,11	60	90	34	16	94
4"	16	523 00 110 2		0,2	30	110	40	17	138

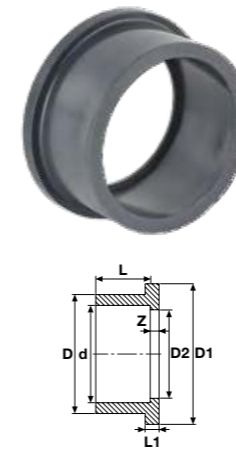
UH-PVC Yapıştırma Muflu Kole
 UH-PVC Solvent Cement Flange Adaptor

d mm	Basınç PN	Kod Code	Fiyat (Adet) Price (Pcs)	Kg /Adet Kg/Pcs	Koli/Adet Box/Pcs	DN1 (mm)	D (mm)	D1 (mm)	L (mm)	L1 (mm)	Z (mm)
16	16	512 00 016 2		0,012	600	12	22	34,0	14,0	7	3
20	16	512 00 020 2		0,009	750	15	27	34,0	16,0	7	3
25	16	512 00 025 2		0,01	450	20	33	41,0	19,0	7	3
32	16	512 00 032 2		0,02	250	25	41	50,0	22,0	7	3
40	16	512 00 040 2		0,04	150	32	50	61,0	26,0	8	3
50	16	512 00 050 2		0,06	160	40	60	73,0	31,0	8	3
63	16	512 00 063 2		0,09	100	50	77	91,0	38,0	9	3
75	16	512 00 075 2		0,16	70	65	90	106,0	43,5	10	3
90	16	512 00 090 2		0,23	85	80	107	125,0	51,0	11	5
110	16	512 00 110 2		0,41	45	100	129	150,0	61,0	12	5
125	16	512 00 125 2		0,60	24	110	147	170,0	69,0	13	5
140	16	512 00 140 2		0,78	18	125	164	188,0	76,0	14	5
160	16	512 00 160 2		1,10	16	150	188	213,0	86,0	16	5
200	16	512 00 200 2		1,45	7	175	230	255,0	106,0	18	6
225	16	512 00 225 2		2,06	3	200	245	274,0	120,0	24	6
250	10	512 00 250 2		2,75	4	250	269	303,0	131,0	20	9
280	10	512 00 280 2		3,05	2	250	304	329,0	146,0	20	5
315	10	512 00 315 2		3,95	2	300	341	346,0	164,0	20	8
355	10	512 00 355 5		5,7	1	350	384	430,0	184,0	28	10
400	4	512 00 400 4		7,05	1	400	450	482,0	206,0	25	10
450	4	512 00 450 5		-	1	-	-	-	-	-	-
500	4	512 00 500 5		-	1	-	-	-	-	-	-

UH-PVC İçten Dişli Kole
 UH-PVC Female Threaded Flange Adaptor

Rp Inch	Basınç PN	Kod Code	Fiyat (Adet) Price (Pcs)	Kg /Adet Kg/Pcs	Koli/Adet Box/Pcs	DN (mm)	D (mm)	D1 (mm)	L (mm)	L1 (mm)	Z (mm)
*3/8"	16	512 02 016 2		0,01	600	12	27	34,0	14,0	7	3
1/2"	16	512 02 020 2		0,01	750	15	27	34,0	16,0	7	3
3/4"	16	512 02 025 2		0,01	450	20	33	41,0	19,0	7	3
1"	16	512 02 032 2		0,02	250	25	41	50,0	22,0	7	3
1 1/4"	16	512 02 040 2		0,03	150	32	50	61,0	26,0	8	3
1 1/2"	16	512 02 050 2		0,07	160	40	60	73,0	35,0	8	3
2"	16	512 02 063 2		0,13	100	50	77	91,0	38,0	9	3
2 1/2"	16	512 02 075 2		0,12	60	65	90	106,0	43,0	10	3
3"	16	512 02 090 2		0,27	85	80	107	125,0	51,0	11	5
4"	16	512 02 110 2		0,35	45	100	129	150,0	60,0	12	5

*Konfeksiyon / Hand-made

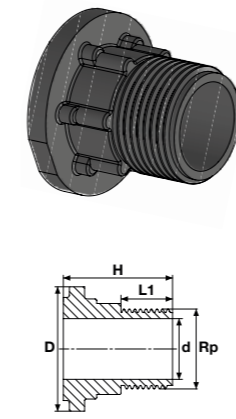
UH-PVC Dıştan Dişli Kole
 UH-PVC Male Threaded Flange Adaptor

d (mm)	Rp (mm)	Basınç PN	Kod Code	Fiyat (Adet) Price (Pcs)	Kg /Adet Kg/Pcs	Koli/Adet Box/Pcs	L1 (mm)	D (mm)	H (mm)
50	1 1/2"	16	229 06 050 2		0,09	50	25	62,5	52
63	2"	16	229 06 063 2		0,14	25	27	78	57,5
63	1 1/2"	16	229 07 063 2		0,12	25	32	106	68

UH-PVC Yapıştırma Flanşlı Manşon

UH-PVC Solvent Cement Flange Socket

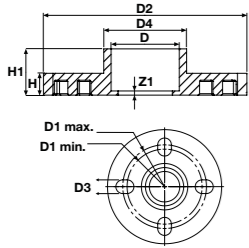

d (mm)	Basınç PN	Kod Code	Fiyat (Adet) Price (Pcs)	Koli/Adet Box/Pcs	D1 Min. (mm)	D1 Max. (mm)	D2 (mm)	D3 (mm)	D4 (mm)	N (Adet)	H (mm)	H1 (mm)	Z1 (mm)
*20	16	512 50 020 2			60,5	65	95	15,75	27	4	12	21,5	3
25	16	512 50 025 2			70	75	105	15,75	33	4	12	21,5	3
*32	16	512 50 032 2			79,2	85	115	15,75	41	4	14	25	3
*40	16	512 50 040 2			88,9	100	140	18	50	4	15	29	3
*50	16	512 50 050 2			98,6	110	150	18	61	4	16	34	3
63	16	512 50 063 2			120,6	124	165	19	76	4	18	40,5	3
75	16	512 50 075 2			139,7	145	185	19	90	4	19	46,5	3
90	16	512 50 090 2			152,4	160	200	19	108	8	20	56	5
110	16	512 50 110 2		10	180	190,5	220	19	131	8	22	66	5
125	16	512 50 125 2		8	210	-	250	19	148	8	26	73,5	5
140	16	512 50 140 2		8	210	-	250	19	165	8	26	81	5
160	16	512 50 160 2		12	240	-	285	22	188	8	28	91	5
200	16	512 50 200 2			295	-	340	22	224	8	36	111	5

*U-PVC Borudan Konfeksiyon / U-PVC Hand-made from pipe

UH-PVC Yapıştırma Muflu Serbest Flanş

UH-PVC Solvent Cement Flange

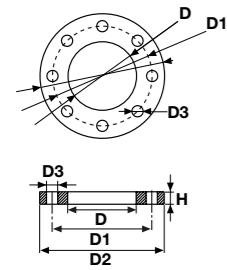

d (mm)	Basınç PN	Kod Code	Fiyat (Adet) Price (Pcs)	Kg /Adet Kg/Pcs	Koli/Adet Box/Pcs	Inch	DN (mm)	D (mm)	D1 (mm)	D2 (mm)	D3 (mm)	H (mm)	N (Adet)
20	16	513 00 020 2		0,10	150	1/2"	15	28	65	96	14	11	4
25	16	513 00 025 2		0,12	100	3/4"	20	34	75	105	14	12	4
32	16	513 00 032 2		0,18	80	1"	25	42	85	115	14	14	4
40	16	513 00 040 2		0,29	50	1 1/4"	32	51	100	140	14	15	4
50	16	513 00 050 2		0,23	48	1 1/2"	40	62	110	150	18	16	4
63	16	513 00 063 2		0,30	25	2"	50	78	125	165	18	18	4
75	16	513 00 075 2		0,40	40	2 1/2"	65	92	145	185	18	20	4
90	16	513 00 090 2		0,46	35	3"	80	111	160	200	18	22	8
110	16	513 00 110 2		0,53	22	4"	100	133	180	220	18	24	8
125	16	513 00 125 2		0,78	18	4 1/2"	110	150	210	250	18	26	8
140	16	513 00 140 2		0,74	18	5"	125	167	210	250	18	26	8
160	16	513 00 160 2		0,81	14	6"	150	193	250	285	22	28	8
200	16	513 00 200 2		1,67	8	7"	175	226	295	340	22	32	8
225	16	513 00 225 2		1,23	8	8"	200	257	295	340	22	32	8
250	16	513 00 250 2		2,19	7	9"	250	278	325	370	22	36	8
280	10	513 00 280 2		1,58	7	10"	250	310	350	395	22	36	12
315	10	513 00 315 2		2,96	7	12"	300	348	400	445	22	36	12
355	10	513 00 355 4			1	14"	350	388	460	505	22	38	16
400	10	513 00 400 4			1	16"	400	442	515	565	26	42	16
450	10	513 00 450 5			1								
500	10	513 00 500 5			1								

UH-PVC Tamir Flanş

UH-PVC Repair Flange

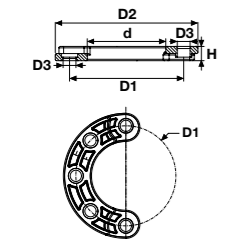

d (mm)	Basınç PN	Kod Code	Fiyat (€/Adet) Price (€/Pcs)	Kg /Adet Kg/Pcs	Koli/Adet Box/Pcs	D1 (mm)	D2 (mm)	D3 (mm)	H (mm)
90	10	513 16 090 2		0,430	35	160	200	18	20
110	10	513 16 110 2		0,535	22	180	220	18	22
125	10	513 16 125 2		0,820	18	210	250	18,5	25
140	10	513 16 140 2		0,725	18	210	250	18	25,5
160	10	513 16 160 2		0,950	14	240	285	22	28
200	10	513 16 200 2		1,450	11	295	340	22	30

UH-PVC Yapıştırma Muflu Kör Flanş

UH-PVC Solvent Cement Blind Flange

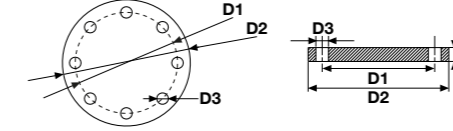

d mm	Inch	Basınç PN	Kod Code	Fiyat (Adet) Price (Pcs)	Kg /Adet Kg/Pcs	Koli/Adet Box/Pcs	DN (mm)	D1 (mm)	D2 (mm)	D3 (mm)	H (mm)	N (Adet)
20	1/2"	16	514 00 020 2		0,09	149	15	65	96	14	12	4
25	3/4"	16	514 00 025 2		0,14	110	20	75	105	14	13	4
32	1"	16	514 00 032 2		0,17	80	25	85	115	14	15	4
40	1 1/4"	16	514 00 040 2		0,28	50	32	100	140	14	16	4
50	1 1/2"	16	514 00 050 2		0,37	48	40	110	150	18	17	4
63	2"	16	514 00 063 2		0,57	25	50	125	165	18	20	4
75	2 1/2"	16	514 00 075 2		0,74	16	65	145	185	18	21	4
90	3"	16	514 00 090 2		0,85	14	80	160	200	18	22	8
110	4"	16	514 00 110 2		1,56	11	100	180	220	18	24	8
125	4 1/2"	16	514 00 125 2		1,62	18	125	210	250	18	28	8
140	5"	16	514 00 140 2		1,62	1	125	210	250	18	28	8
160	6"	16	514 00 160 2		2,58	18	150	250	285	22	28	8
200	7"	16	514 00 200 2		3,82	14	200	295	340	22	32	8
225	7"	16	514 00 225 2		3,82	8	200	295	340	22	32	8
250	8"	16	514 00 250 4			8	250	350	395	22	36	8
280	9"	10	514 00 280 4			8	250	350	395	22	36	12
315	10"	10	514 00 315 4			7	300	400	445	22	36	12
355	12"	10	514 00 355 4			7	350	460	505	22	38	16
400	14"	10	514 00 400 4			7	400	515	565	26	40	16
450	16"	10	514 00 450 5			7						
500		10	514 00 500 5			7						

UH-PVC Yapıştırma Muflu Flanş Takım

UH-PVC Solvent Cement Flange Set

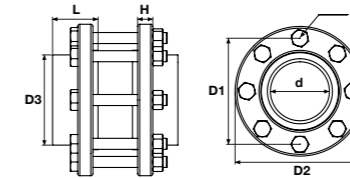

d (mm)	Inch	Basınç PN	Kod Code	Fiyat (Adet) Price (Pcs)	Kg /Adet Kg/Pcs	Koli/Adet Box/Pcs	DN (mm)	D1 (mm)	D2 (mm)	D3 (mm)	D4 (mm)	L (Adet)	H (mm)	N (Adet)
20	1/2"	16	513 07 020 2			16	15	65	96	27	14	17	11	4
25	3/4"	16	513 07 025 2			16	20	75	105	33	14	22	12	4
32	1"	16	513 07 032 2			16	25	85	115	41	14	25	14	4
40	1 1/4"	16	513 07 040 2			16	32	100	140	50	14	29	15	4
50	1 1/2"	16	513 07 050 2			16	40	110	150	60	18	34	16	4
63	2"	16	513 07 063 2		1,64	1	50	125	165	77	18	41	18	4
75	2 1/2"	16	513 07 075 2		2,06	1	65	145	185	90	18	46,5	20	4
90	3"	16	513 07 090 2		3,43	1	80	160	200	107	18	56	22	8
110	4"	16	513 07 110 2		3,90	1	100	180	220	129	18	66	24	8
125	4 1/2"	16	513 07 125 2		4,80	1	110	210	250	147	18	74	26	8
140	5"	16	513 07 140 2		5,30	1	125	210	250	164	18	81	26	8
160	6"	16	513 07 160 2		6,00	1	150	250	285	188	22	91	28	8
200	7"	16	513 07 200 2		8,60	1	175	295	340	230	22	112	32	8
225	8"	10	513 07 225 2		8,80	1	200	295	340	245	22	126	32	8
250	9"	10	513 07 250 2		13,50	1	250	325	370	269	22	140	36	8
280	10"	10	513 07 280 2		12,85	1	250	350	395	304	22	151	36	12
315	12"	10	513 07 315 2		15,80	1	300	400	445	341	22	172	36	12
355	14"	10	513 07 355 2			1	350	460	505	384	22	194	38	16
400	16"	10	513 07 400 2			1	400	515	565	450	26	216	42	16
*450	-	10	513 07 450 2			1	-	-	-	-	-	-	-	-
*500	-	10	513 07 500 2			1	-	-	-	-	-	-	-	-

*Konfeksiyon / Hand-made

UH-PVC Yapıştırma Muflu Beton Geçiş Flanşı
 UH-PVC Solvent Cement Wall Cross Flange

d mm	Inch	Basınç PN	Kod Code	Fiyat (Adet) Price (Pcs)	Kg /Adet Kg/Pcs	Koli/Adet Box/Pcs	DN (mm)	E (mm)	L (mm)	Z (mm)
50	1 1/2"	16	515 00 050 2		0,03	200	40	80	26	4
63	2"	16	515 00 063 2		0,04	125	50	96	30	4
75	2 1/2"	16	515 00 075 2		0,06	90	65	111	30	4
90	3"	16	515 00 090 2		0,07	100	80	129	30	5
110	4"	16	515 00 110 2		0,08	80	100	149	30	5
125	4 1/2"	16	515 00 125 2		0,11	35	110	164	31	5
140	5"	16	515 00 140 2		0,12	33	125	180	31	5
160	6"	16	515 00 160 2		0,13	50	150	199	31	5
200	7"	16	515 00 200 2		0,13	25	175	245	20	6
*225	7"	10	515 00 225 2		0,16	10	200	308	41	6
*250	8"	10	515 00 250 5			7	250	272	57	8
*280	9"	10	515 00 280 5			6	250	329	70	8
*315	10"	10	515 00 315 5			5	300	346	80	9
*355	12"	10	515 00 355 5			5	350	430	92	9
*400	14"	10	515 00 400 5			5	400	482	103	9

*U-PVC Borudan Konfeksiyon. / U-PVC Hand-made from pipe

UH-PVC Somun

UH-PVC Male Threaded Nut



Rp Inch	Basınç PN	Kod Code	Fiyat (Adet) Price (Pcs)	Kg /Adet Kg/Pcs	Koli/Adet Box/Pcs	L (mm)	Z (mm)	s (mm)
1/2"	16	527 00 020 4		0,01	400	35	13	32
3/4"	16	527 00 025 4		0,01	400	39	13	32
1"	16	527 00 032 4		0,02	240	48	15	40
1 1/4"	16	527 00 040 4		0,02	300	58	17	50
1 1/5"	16	527 00 050 4		0,04	150	65	18	56
2"	16	527 00 063 4		0,04	140	79	21	69
*2 1/2"	16	527 00 075 4		0,06	25	94	23	85
*3"	16	527 00 090 4		0,10	20	112	26	100
*4"	16	527 00 110 4		0,16	2	160	36	147

*Konfeksiyon / Hand-made

UH-PVC Dış Dişli Parça

UH-PVC Male Threaded Piece



Rp Inch	Basınç PN	Kod Code	Fiyat (Adet) Price (Pcs)	Kg /Adet Kg/Pcs	Koli/Adet Box/Pcs	L (mm)
1/2"	16	526 00 020 5		0,01	400	60
3/4"	16	526 00 025 5		0,01	225	60
1"	16	526 00 032 5		0,02	140	80
1 1/4"	16	526 00 040 5		0,04	150	80
1 1/5"	16	526 00 050 5		0,06	125	80
2"	16	526 00 063 5		0,12	70	100
2 1/2"	16	526 00 075 5		0,21	80	120
3"	16	526 00 090 5		0,38	40	150
4"	10	526 00 110 5		0,50	30	150

UH-PVC Yapıştırma Muflu TYP-B Dıştan Dişli Depo Bağlantı Adaptörü (Uzun Tip)
 UH-PVC Solvent Cement TYP-B Male Threaded Tank Adaptor (Long Type)

d1 (mm)	Basınç PN	Kod Code	Fiyat (Adet) Price (Pcs)	Kg /Adet Kg/Pcs	Koli/Adet Box/Pcs	d2 (mm)	d3 (mm)	Z1 (mm)	Z2 (mm)	B (mm)	C (mm)	D (mm)	S (mm)
20	10	528 00 020 5		0,03	20	3/4"	3/4"	13	0-23	16	17	42	32
25	10	528 00 025 5		0,05	10	1"	1"	15	0-23	19	21	45	40
32	10	528 00 032 5		0,10	40	1 1/4"	1 1/4"	17	0-26	22	23	49	50
40	10	528 00 040 5		0,22	50	1 1/2"	1 3/4"	19	0-21	26	23	48	60
50	10	528 00 050 5		0,25	50	2"	2"	21	0-21	31	27	52	69
50	10	528 01 050 5		0,38	50	2"	2 1/4"	21	0-21	31	27	52	76
63	10	528 00 063 5		0,37	20	2 1/2"	2 1/2"	23	0-23	38	31	53	85
75	10	528 00 075 5		0,59	5	3"	3"	26	0-20	44	34	56	100
90	10	528 00 090 5		0,69	10	4"	113"	32	0-20	51	40	62	125
*110	10	528 00 110 5		1,58	12								
*125	10	528 00125 5		0,30	1								
*140	10	528 00 140 5		1,97	4								
*160	10	528 00 160 5			2								
*200	10	528 00 200 5			1								

*U-PVC Borudan Konfeksiyon. / U-PVC Hand-made from pipe

U-PVC Depo Bağlantı Adaptör Yaprak Contası EPDM

U-PVC Tank Adaptor EPDM Rubber Flat Gasket



Çap Dia	Kod Code	Fiyat (Adet) Price (Pcs)	Kg /Adet Kg/Pcs	Poşet/Adet Bag/Pcs
20	221 05 020 1		1,50	100
25	221 05 025 1		2,50	100
32	221 05 032 1		5,00	100
40	221 05 040 1		6,00	100
50	221 05 050 1		7,00	100
63	221 05 063 1		10,50	100
75	221 05 075 1		15,00	100
90	221 05 090 1		21,50	100
110	221 05 110 1		23,50	100

EPDM Yaprak Conta

EPDM Rubber Flat Gasket



Çap Dia	Kod Code	Fiyat (Adet) Price (Pcs)	Kg /Adet Kg/Pcs	Poşet/Adet Bag/Pcs
63	221 05 063 9		10,50	50
75	221 05 075 9		15,00	50
90	221 05 090 9		21,50	50
110	221 05 110 9		22,50	50
125	221 05 125 9		52,50	50
140	221 05 140 9		60,50	50
160	221 05 160 9			50
200	221 05 200 9			20
225	221 05 225 9			20
250	221 05 250 9			20
280	221 05 280 9			20
315	221 05 315 9			20
355	221 05 355 9			20
400	221 05 400 9			20

Not / Note

U-PVC

RAKOR

UNION

ÜRETİM STANDARDI
PRODUCTION STANDARD | EN 1452-3

ÇAP / SIZE Ø20 - Ø110



UH-PVC Rakor
UH-PVC Union

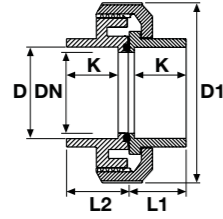

Su için / For Water

Asit için / For Acid

Çap Dia	Basınç PN	EPDM Conta Kod EPDM O-Ring Code	Fiyat (Adet) Price (Pcs)	FKM Conta Kod FKM O-Ring Code	Fiyat (Adet) Price (Pcs)	Kg /Adet Kg/Pcs	Koli/Ad. Box/Pcs	DN (mm)	D1 (mm)	L1 (mm)	L2 (mm)	K (mm)
16	16	227 00 016 2		227 55 016 2		0,05	125	12	53	19	24	16
20	16	227 00 020 2		227 55 020 2		0,05	125	15	54	19	24	16
25	16	227 00 025 2		227 55 025 2		0,07	100	20	62	22	27	19
32	16	227 00 032 2		227 55 032 2		0,09	50	25	65	25	30	22
40	16	227 00 040 2		227 55 040 2		0,16	30	32	83	28	36	26
50	16	227 00 050 2		227 55 050 2		0,189	45	40	93	38	42	31
63	16	227 00 063 2		227 55 063 2		0,35	30	50	116	41	52	38
75	16	227 00 075 2		227 55 075 2		0,585	18	65	129	47	54	44
90	16	227 00 090 2		227 55 090 2		0,98	12	80	155	56	61	51
110	16	227 00 110 2		227 55 110 2		1,47	7	100	178	66	71	61

UH-PVC Çift Taraf İçten Dişli Rakor
UH-PVC Both Sides Female Threaded Union

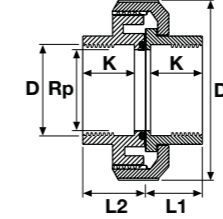

Su için / For Water

Asit için / For Acid

Rp (Inch)	Basınç PN	EPDM Conta Kod EPDM O-Ring Code	Fiyat (Adet) Price (Pcs)	FKM Conta Kod FKM O-Ring Code	Fiyat (Adet) Price (Pcs)	Kg /Adet Kg/Pcs	Koli/Ad. Box/Pcs	DN (mm)	D1 (mm)	L1 (mm)	L2 (mm)	K (mm)
3/8"	16	229 00 016 2		229 55 016 2		0,05	125	12	53	19	24	16
1/2"	16	229 00 020 2		229 55 020 2		0,05	125	15	54	19	24	16
3/4"	16	229 00 025 2		229 55 025 2		0,07	100	20	62	22	27	19
1"	16	229 00 032 2		229 55 032 2		0,09	50	25	65	25	30	22
1 1/4"	16	229 00 040 2		229 55 040 2		0,15	30	32	83	28	36	26
1 1/2"	16	229 00 050 2		229 55 050 2		0,25	45	40	93	38	42	31
2"	16	229 00 063 2		229 55 063 2		0,5	30	50	116	41	52	38
2 1/2"	16	229 00 075 2		229 55 075 2		0,61	18	65	129	47	54	44
3"	16	229 00 090 2		229 55 090 2		1,04	12	80	155	56	61	51
4"	16	229 00 110 2		229 55 110 2		1,415	7	100	178	66	71	61

UH-PVC Tek Taraf İçten Dişli Rakor
UH-PVC One Side Female Threaded Union

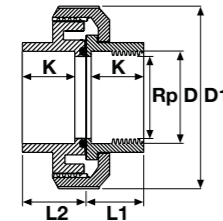

Su için / For Water

Asit için / For Acid

Çap Dia	Rp (Inch)	Basınç PN	EPDM Conta Kod EPDM O-Ring Code	Fiyat (Adet) Price (Pcs)	FKM Conta Kod FKM O-Ring Code	Fiyat (Adet) Price (Pcs)	Kg /Adet Kg/Pcs	Koli/Ad. Box/Pcs	DN (mm)	D1 (mm)	L1 (mm)	L2 (mm)	K (mm)
16	3/8"	16	228 00 016 2		228 55 016 2		0,05	125	12	53	19	24	16
20	1/2"	16	228 00 020 2		228 55 020 2		0,05	125	15	54	19	24	16
25	3/4"	16	228 00 025 2		228 55 025 2		0,07	100	20	62	22	27	19
32	1"	16	228 00 032 2		228 55 032 2		0,085	50	25	65	25	30	22
40	1 1/4"	16	228 00 040 2		228 55 040 2		0,155	30	32	83	28	36	26
50	1 1/2"	16	228 00 050 2		228 55 050 2		0,25	45	40	93	38	42	31
63	2"	16	228 00 063 2		228 55 063 2		0,48	30	50	116	41	52	38
75	2 1/2"	16	228 00 075 2		228 55 075 2		0,6	18	65	129	47	54	44
90	3"	16	228 00 090 2		228 55 090 2		1,005	12	80	155	56	61	51
110	4"	16	228 00 110 2		228 55 110 2		1,485	7	100	178	66	71	61

UH-PVC Pompa Rakoru Dış Diş
UH-PVC Male Threaded Union

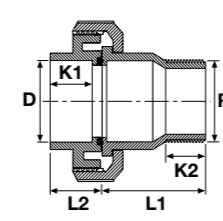

Su için / For Water

Asit için / For Acid

Çap Dia	Rp (Inch)	Basınç PN	EPDM Conta Kod EPDM O-Ring Code	Fiyat (Adet) Price (Pcs)	FKM Conta Kod FKM O-Ring Code	Fiyat (Adet) Price (Pcs)	Kg /Adet Kg/Pcs	Koli/Ad. Box/Pcs	DN (mm)	D1 (mm)	L1 (mm)	L2 (mm)	K1 (mm)	K2 (mm)
50	1 1/2"	16	230 00 050 2		230 55 050 2		0,23	50	40	50	81	45	31	22
63 x 50	1 1/2"	16	230 00 063 2		230 55 063 2		0,37	30	50	63	61	55	38	22
63	2"	16	230 01 063 2		230 56 063 2		0,39	25	50	63	72	55	38	27

UH-PVC Rakor Dış Dış Piriç Çıkışlı

UH-PVC Union Outlet Male Brass Threaded

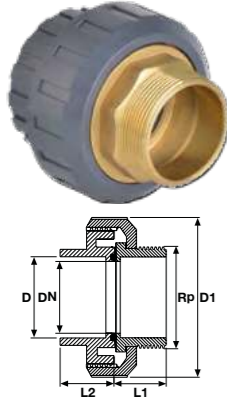

Çap Dia	Rp Inch	Basınç PN	EPDM Conta Kod EPDM O-Ring Code	Fiyat (Adet) Price (Pcs)	Kg /Adet Kg/Pcs	Koli/Adet Box/Pcs	DN (mm)	D1 (mm)	L1 (mm)	L2 (mm)
20	1/2"	16	242 30 020 2		0,105	125	15	15	19	25
25	3/4"	16	242 30 025 2			100	20	20	21	29
32	1"	16	242 30 032 2			50	25	25	25	32
40	1 1/4"	16	242 30 040 2		0,31	50	32	32	29	39
50	1 1/2"	16	242 30 050 2		0,455	30	40	40	34	45
63	2"	16	242 30 063 2		0,765	15	50	50	41	55

UH-PVC Çıkışlı Piriç Rakor Dış Dişli

UH-PVC Outlet Brass Union Male Threaded

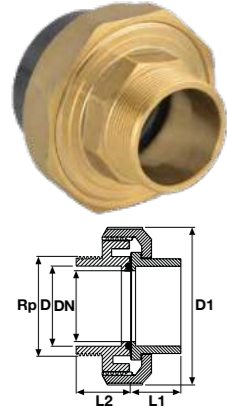

Çap Dia	Rp Inch	Basınç PN	EPDM Conta Kod EPDM O-Ring Code	Fiyat (Adet) Price (Pcs)	Kg /Adet Kg/Pcs	Koli/Adet Box/Pcs	DN (mm)	D1 (mm)	L1 (mm)	L2 (mm)
20	1/2"	16	242 00 020 2		0,08	125	15	36	19	14
25	3/4"	16	242 00 025 2		0,14	100	20	45	22	15
32	1"	16	242 00 032 2		0,17	50	25	51	25	17
40	1 1/4"	16	242 00 040 2		0,34	50	32	64	28	24
50	1 1/2"	16	242 00 050 2		0,52	30	40	80	38	22
63	2"	16	242 00 063 2		0,68	24	50	98	41	23

UH-PVC Rakor İç Dış Piriç Çıkışlı

UH-PVC Union Outlet Female Brass Threaded

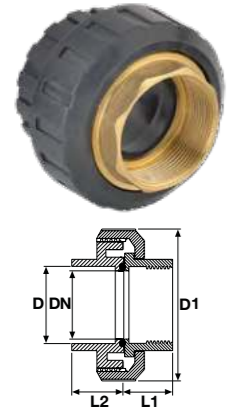

Çap Dia	R Inch	Basınç PN	EPDM Conta Kod EPDM O-Ring Code	Fiyat (Adet) Price (Pcs)	Kg /Adet Kg/Pcs	Koli/Adet Box/Pcs	DN (mm)	D1 (mm)	L1 (mm)	L2 (mm)
20	1/2"	16	242 20 020 2		0,09	125	15	36	19	14
25	3/4"	16	242 20 025 2		0,10	100	20	45	21	15
32	1"	16	242 20 032 2		0,15	50	25	51	25	17
40	1 1/4"	16	242 20 040 2		0,32	50	32	64	29	24
50	1 1/2"	16	242 20 050 2		0,39	30	40	80	34	22
63	2"	16	242 20 063 2		0,66	10	50	98	41	23

UH-PVC Çıkışlı Piriç Rakor İç Dişli

UH-PVC Outlet Brass Union Female Threaded

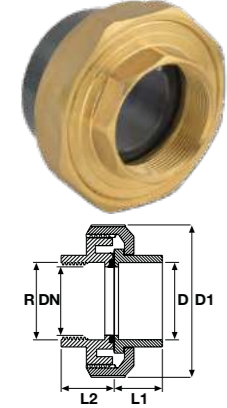

Çap Dia	R Inch	Basınç PN	EPDM Conta Kod EPDM O-Ring Code	Fiyat (Adet) Price (Pcs)	Kg /Adet Kg/Pcs	Koli/Adet Box/Pcs	DN (mm)	D1 (mm)	L1 (mm)	L2 (mm)
20	1/2"	16	242 10 020 2		0,07	50	15	36	19	14
25	3/4"	16	242 10 025 2		0,10	100	20	45	22	15
32	1"	16	242 10 032 2		0,15	90	25	51	25	17
40	1 1/4"	16	242 10 040 2		0,28	80	32	64	28	24
50	1 1/2"	16	242 10 050 2		0,41	30	40	80	38	22
63	2"	16	242 10 063 2		0,77	24	50	98	41	23

UH-PVC Gözetleme Camı

UH-PVC Inspection Glass

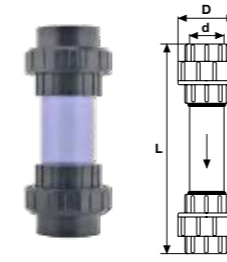

Çap Dia	Basınç PN	EPDM Conta Kod EPDM O-Ring Code	Fiyat (Adet) Price (Pcs)	Kg /Adet Kg/Pcs	Koli/Adet Box/Pcs	DN (mm)	D (mm)	L (mm)
20	10	231 00 020 2		0,13	100	15	51	205
25	10	231 00 025 2		0,18	100	20	57	219
32	10	231 00 032 2		0,31	50	25	67	230
40	10	231 00 040 2		0,43	50	32	82	244
50	10	231 00 050 2		0,53	30	40	88	272
63	10	231 00 063 2		0,91	25	50	107	368
75	10	231 00 075 2		1,39	10	63	131	320
90	10	231 00 090 2		2,27	5	80	147	351
110	10	231 00 110 2			2	100	176	420



Çap Dia	Basınç PN	EPDM Conta Kod EPDM O-Ring Code	Fiyat (Adet) Price (Pcs)	Kg /Adet Kg/Pcs	Koli/Adet Box/Pcs	DN (mm)	D1 (mm)	L (mm)	L1 (mm)	nQe
125	10	231 00 125 2		6,29	1	110	250	254	110	8-Q16
140	10	231 00 140 2		6,75	1	125	250	265	110	8-Q16
160	10	231 00 160 2		10,7	2	150	285	315	110	8-Q20
200	10	231 00 200 2		14,5	1	175	340	315	80	8-Q20
225	10	231 00 225 2		14,7	1	200	340	315	80	8-Q20

Flanş Bağlantılı / With Flange

UH-PVC Seviye Göstergesi

UH-PVC Variable Area Flow Meter

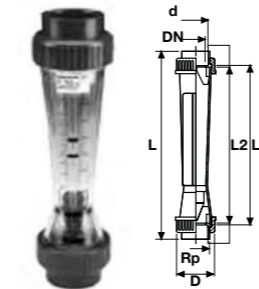

Çap Dia (Inch)	Rp	EPDM Conta Kod EPDM O-Ring Code	Fiyat (Adet) Price (Pcs)	Kg/Adet Kg/Pcs	Koli/Adet Box/Pcs	DN (mm)	D (mm)	L (mm)	L1 (mm)	L2 (mm)	Scale Range (l/h)	Type
32	1"	231 00 900 4		0,41	1	25	60	385	341	335	50 - 500	SK 10
32	1"	231 00 902 4		0,41	1	25	60	385	341	335	100 - 1000	SK 11
32	1"	231 00 734 4		0,41	1	25	60	385	341	335	150 - 1500	SK 12
50	1 1/2"	231 00 738 4		1,02	1	40	83	403	341	335	200 - 2000	SK 18
50	1 1/2"	231 00 741 4		1,02	1	40	83	403	341	335	250 - 2500	SK 19
50	1 1/2"	231 00 904 4		1,02	1	40	83	403	341	335	300 - 3000	SK 20
50	1 1/2"	231 00 906 4		1,02	1	40	83	403	341	335	600 - 6000	SK 21
63	2"	231 00 744 4		1,38	1	50	103	417	341	335	600 - 6000	SK 29
63	2"	231 00 908 4		1,38	1	50	103	417	341	335	1000 - 10000	SK 30
63	2"	231 00 910 4		1,38	1	50	103	417	341	335	1500 - 15000	SK 31
75	2 1/2"	231 00 330 4		2,15	1	65	122	457	342	335	2000 - 20000	SK 40
75	2 1/2"	231 00 332 4		2,15	1	65	122	457	342	335	3000 - 30000	SK 41

UH-PVC Temizleme Y. Filtresi

UH-PVC Line Strainer (Transparent Body)



Çap Dia	Basınç PN	EPDM Conta Kod EPDM O-Ring Code	Fiyat (Adet) Price (Pcs)	Kg/Adet Kg/Pcs	Koli/Adet Box/Pcs	DN (mm)	D (mm)	L (mm)	L1 (mm)	L2 (mm)
20	10	231 00 300 4		0,11	1	15	43	124	130	28
25	10	231 00 350 4		0,17	1	20	47	144	150	37
32	10	231 00 400 4		0,22	1	25	56	154	160	37
40	10	231 00 450 4		0,38	1	32	64	174	180	44
50	10	231 00 500 4		0,63	1	40	82	194	200	48
63	10	231 00 550 4		1,05	1	50	95	224	230	60
75	10	231 00 600 4		1,83	1	65	106	284	290	74
90	10	231 00 650 4		2,56	1	80	120	300	310	85

Metal Körüklü Kompansatörler / Hareketli Flanş (30 mm Layersiz)
Metal Bellows Compensator / Moving Flange (30 mm Without Liner)



Çap Dia	Kod Code	Fiyat (Adet) Price (Pcs)	Kg /Adet Kg/Pcs
40	120 12 040 8		
50	120 12 050 8		3,79
63	120 12 063 8		4,80
75	120 12 075 8		5,60
90	120 12 090 8		
110	120 12 110 8		8,20
140	120 12 140 8		9,80
160	120 12 160 8		12,4
225	120 12 225 8		20,3
280	120 12 280 8		24,8
315	120 12 315 8		35,0

Metal Körüklü Kompansatörler / Hareketli Flanş (30 mm Laynerli)
Metal Bellows Compensator / Moving Flange (30 mm With Liner)



Çap Dia	Kod Code	Fiyat (Adet) Price (Pcs)	Kg /Adet Kg/Pcs
40	120 13 040 8		
50	120 13 050 8		4,10
63	120 13 063 8		5,20
75	120 13 075 8		6,20
90	120 13 090 8		7,00
110	120 13 110 8		8,00
140	120 13 140 8		12,2
160	120 13 160 8		13,8
225	120 13 225 8		17,4
280	120 13 280 8		26,0

Kauçuk Kompansatörler
Rubber Compensator



Çap Dia	Kod Code	Fiyat (Adet) Price (Pcs)	Kg /Adet Kg/Pcs
40	120 10 040 8		3,00
50	120 10 050 8		3,80
63	120 10 063 8		4,50
75	120 10 075 8		5,20
90	120 10 090 8		6,70
110	120 10 110 8		7,80
140	120 10 140 8		9,60
160	120 10 160 8		11,8
225	120 10 225 8		16,8
280	120 10 280 8		20,0
315	120 10 315 8		28,0
355	120 10 355 8		42,4
400	120 10 400 8		46,0

Kauçuk Kompansatörler / Rakor Bağlantılı
Rubber Compensator With Union Connection



Çap Dia	Kod Code	Fiyat (Adet) Price (Pcs)	Kg /Adet Kg/Pcs
40	120 11 040 8		1,4
50	120 11 050 8		2
63	120 11 063 8		2,6
75	120 11 075 8		4
90	120 11 090 8		5,6

U-PVC

ÇEKVALF

CHECKVALVE

ÜRETİM STANDARDI

PRODUCTION STANDARD

EN 1452-3

ÇAP / SIZE Ø20 - Ø400

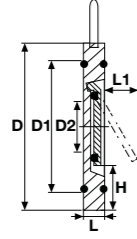

U-PVC Çıplak Çalparalı Çekvalf
 U-PVC Wafer Check Valve

Su için / For Water

Asit için / For Acid

Çap Dia	Basınç PN	EPDM Conta Kod EPDM O-Ring Code	Fiyat (Adet) Price (Pcs)	FPM Conta Kod FPM O-Ring Code	Fiyat (Adet) Price (Pcs)	Kg /Adet Kg/Pcs	Koli/Ad. Box/Pcs	DN (mm)	D (mm)	D1 (mm)	D2 (mm)	L (mm)	L1 (mm)	H (mm)
63	10	221 01 063 9		221 02 063 9		0,19	5	50	90	75	32	16	40	18
75	10	221 01 075 9		221 02 075 9		0,26	5	65	110	95	40	16	55	20
90	10	221 01 090 9		221 02 090 9		0,34	5	80	125	115	54	16	67	23
110	10	221 01 110 9		221 02 110 9		0,48	5	100	184	135	70	19	67	35
125	10	221 01 125 9		221 02 125 9		0,55	5	100	213	160	92	21	94	37
140	10	221 01 140 9		221 02 140 9		0,64	5	125	213	160	92	21	94	37
160	10	221 01 160 9		221 02 160 9		0,95	5	150	251	175	105	23	100	47
200	10	221 01 200 9		221 02 200 9		1,32	5	200	280	235	155	27	152	41
225	10	221 01 225 9		221 02 225 9		1,57	5	200	280	235	155	27	152	41
250	10	221 01 250 9		221 02 250 9		2,57	5	250	330	285	330	40	180	41
280	10	221 01 280 9		221 02 280 9		2,58	5	250	330	285	330	40	180	41
315	10	221 01 315 9		221 02 315 9		3,87	5	300	380	325	380	45	215	41

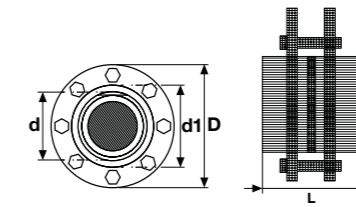
U-PVC Flanş Bağlanılı Çalparalı Çekvalf (Takım-304 Paslanmaz Civata-Somun-Pul)
 U-PVC Wafer Checkvalve With Flange (304 S.S. Screw, Nut, Washer)

Su için / For Water

Asit için / For Acid

Çap Dia	Basınç PN	EPDM Conta Kod EPDM O-Ring Code	Fiyat (Adet) Price (Pcs)	FPM Conta Kod FPM O-Ring Code	Fiyat (Adet) Price (Pcs)	Kg /Adet Kg/Pcs	Koli/Ad. Box/Pcs	DN (mm)	D1 (mm)	D (mm)	L (mm)	nQe (mm)
63	10	221 04 063 2		221 05 063 2		3,10	1	50	77	165	90	4 x 16
75	10	221 04 075 2		221 05 075 2		3,40	1	65	90	185	110	4 x 16
90	10	221 04 090 2		221 05 090 2		3,71	1	80	107	200	126	8 x 16
110	10	221 04 110 2		221 05 110 2		4,56	1	100	129	220	155	8 x 16
125	10	221 04 125 2		221 05 125 2		5,55	1	100	147	250	173	8 x 16
140	10	221 04 140 2		221 05 140 2		5,77	1	125	164	250	182	8 x 16
160	10	221 04 160 2		221 05 160 2		7,47	1	150	188	285	209	8 x 20
200	10	221 04 200 2		221 05 200 2		10,0	1	200	230	340	253	8 x 20
225	10	221 04 225 2		221 05 225 2		10,1	1	200	245	340	285	8 x 20
250	10	221 04 250 2		221 05 250 2		20,6	1	250	269	395	375	12 x 20
280	10	221 04 280 2		221 05 280 2		20,5	1	250	304	395	375	12 x 20
315	10	221 04 315 2		221 05 315 2		25,1	1	300	341	445	415	12 x 20
400	10	221 04 400 2		221 05 400 2			1	400	450	565	482	16 x 24

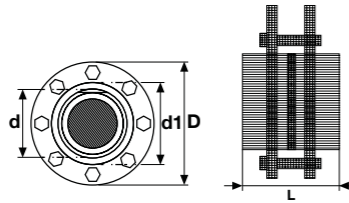
U-PVC Flanş Bağlantılı Çalparalı Çekvalf
 U-PVC Wafer Checkvalve With Flange

Su için / For Water

Asit için / For Acid

Çap Dia	Basınç PN	EPDM Conta Kod EPDM O-Ring Code	Fiyat (Adet) Price (Pcs)	FPM Conta Kod FPM O-Ring Code	Fiyat (Adet) Price (Pcs)	Kg /Adet Kg/Pcs	Koli/Ad. Box/Pcs	DN (mm)	D (mm)	D1 (mm)	L (mm)	nQe (mm)
63	10	221 00 063 2		221 08 063 2		1,83	1	50	165	77	90	4 x 16
75	10	221 00 075 2		221 08 075 2		2,31	1	65	185	90	110	4 x 16
90	10	221 00 090 2		221 08 090 2		3,75	1	80	200	107	126	8 x 16
110	10	221 00 110 2		221 08 110 2		4,35	1	100	220	129	155	8 x 16
125	10	221 00 125 2		221 08 125 2		5,35	1	100	250	147	173	8 x 16
140	10	221 00 140 2		221 08 140 2		5,87	1	125	250	164	182	8 x 16
160	10	221 00 160 2		221 08 160 2		7,03	1	150	285	188	209	8 x 20
200	10	221 00 200 2		221 08 200 2		10,0	1	200	340	230	253	8 x 20
225	10	221 00 225 2		221 08 225 2		10,5	1	200	340	245	285	8 x 20
250	10	221 00 250 2		221 08 250 2		16,2	1	250	395	269	375	12 x 20
280	10	221 00 280 2		221 08 280 2		15,5	1	250	395	304	375	12 x 20
315	10	221 00 315 2		221 08 315 2		19,8	1	300	445	341	415	12 x 20
400	10	221 00 400 2		221 08 400 2			1	400	565	450	482	16 x 24

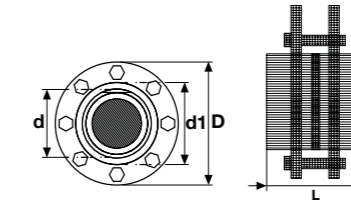
U-PVC Flanş Bağlantılı Çalparalı Çekvalf (Takım-316 Paslanmaz Civata-Somun-Pul)
 U-PVC Wafer Checkvalve With Flange (316 S.S. Screw, Nut, Washer)

Su için / For Water

Asit için / For Acid

Çap Dia	Basınç PN	EPDM Conta Kod EPDM O-Ring Code	Fiyat (Adet) Price (Pcs)	FPM Conta Kod FPM O-Ring Code	Fiyat (Adet) Price (Pcs)	Kg /Adet Kg/Pcs	Koli/Ad. Box/Pcs	DN (mm)	D1 (mm)	D (mm)	L (mm)	nQe (mm)
63	10	221 06 063 2		221 07 063 2		3,10	1	50	77	165	90	4 x 16
75	10	221 06 075 2		221 07 075 2		3,40	1	65	90	185	110	4 x 16
90	10	221 06 090 2		221 07 090 2		3,71	1	80	107	200	126	8 x 16
110	10	221 06 110 2		221 07 110 2		4,56	1	100	129	220	155	8 x 16
125	10	221 06 125 2		221 07 125 2		5,55	1	100	147	250	173	8 x 16
140	10	221 06 140 2		221 07 140 2		5,77	1	125	164	250	182	8 x 16
160	10	221 06 160 2		221 07 160 2		7,47	1	150	188	285	209	8 x 20
200	10	221 06 200 2		221 07 200 2		10,0	1	200	230	340	253	8 x 20
225	10	221 06 225 2		221 07 225 2		10,1	1	200	245	340	285	8 x 20
250	10	221 06 250 2		221 07 250 2		20,6	1	250	269	395	375	12 x 20
280	10	221 06 280 2		221 07 280 2		20,5	1	250	304	395	375	12 x 20
315	10	221 06 315 2		221 07 315 2		25,1	1	300	341	445	415	12 x 20
400	10	221 06 400 2		221 07 400 2			1	400	450	565	482	16 x 24

U-PVC Yapıştırma Muflu Yaylı Çekvalf

U-PVC Solvent Cement Spring Checkvalve

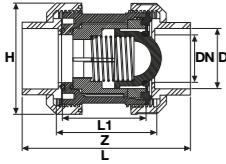

Çap Dia	Basınç PN	EPDM Conta Kod EPDM O-Ring Code	Fiyat (Adet) Price (Pcs)	Kg/Adet Kg/Pcs	Koli/Adet Box/Pcs	DN (mm)	H (mm)	L (mm)	L1 (mm)	Z (mm)
16	16	214 00 016 2		0,10	70	12	54	80	42	50
20	16	214 00 020 2		0,11	70	16	54	85	45	52
25	16	214 00 025 2		0,14	75	20	62	95	49	58
32	16	214 00 032 2		0,20	60	25	66	107	54	61
40	16	214 00 040 2		0,37	32	32	84	128	66	73
50	16	214 00 050 2		0,53	25	40	92	154	75	82
63	16	214 00 063 2		0,95	13	50	116	172	89	95
75	16	214 00 075 2		1,21	7	65	146	196	111	118
90	16	214 00 090 2		3,15	4	80	178	241	126	139
110	16	214 00 110 2		4,59	2	100	210	289	153	165

U-PVC Tek Taraf İçten Dişli Yaylı Çekvalf

U-PVC One Side Female Threaded Spring Checkvalve

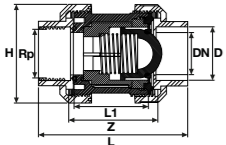

Çap Dia	Rp Inch	Basınç PN	EPDM Conta Kod EPDM O-Ring Code	Fiyat (Adet) Price (Pcs)	Kg/Adet Kg/Pcs	Koli/Adet Box/Pcs	DN (mm)	H (mm)	L (mm)	L1 (mm)	Z (mm)
16	3/8"	16	215 00 016 2		0,10	70	12	54	80	42	50
20	1/2"	16	215 00 020 2		0,11	70	16	54	85	45	52
25	3/4"	16	215 00 025 2		0,14	75	20	62	95	49	58
32	1"	16	215 00 032 2		0,20	60	25	66	107	54	61
40	1 1/4"	16	215 00 040 2		0,37	32	32	84	128	66	73
50	1 1/2"	16	215 00 050 2		0,53	25	40	92	154	75	82
63	2"	16	215 00 063 2		0,95	13	50	116	172	89	95
75	2 1/2"	16	215 00 075 2		1,21	7	65	146	196	111	118
90	3"	16	215 00 090 2		3,15	4	80	178	241	126	139
110	4"	16	215 00 110 2		4,59	2	100	210	289	153	165

U-PVC Çift Taraf İçten Dişli Yaylı Çekvalf

U-PVC Both Sides Female Threaded Spring Checkvalve

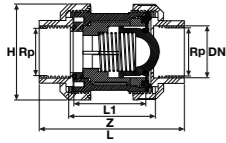

Rp Inch	Basınç PN	EPDM Conta Kod EPDM O-Ring Code	Fiyat (Adet) Price (Pcs)	Kg/Adet Kg/Pcs	Koli/Adet Box/Pcs	DN (mm)	H (mm)	L (mm)	L1 (mm)	Z (mm)
3/8"	16	216 00 016 2		0,10	70	12	54	80	42	50
1/2"	16	216 00 020 2		0,11	70	16	54	85	45	52
3/4"	16	216 00 025 2		0,14	75	20	62	95	49	58
1"	16	216 00 032 2		0,20	60	25	66	107	54	61
1 1/4"	16	216 00 040 2		0,37	32	32	84	128	66	73
1 1/2"	16	216 00 050 2		0,53	25	40	92	154	75	82
2"	16	216 00 063 2		0,95	13	50	116	172	89	95
2 1/2"	16	216 00 075 2		1,21	7	65	146	196	111	118
3"	16	216 00 090 2		3,15	4	80	178	241	126	139
4"	16	216 00 110 2		4,59	2	100	210	289	153	165

U-PVC Flanş Bağlantılı Yaylı Çekvalf

U-PVC Spring Checkvalve Both Sides With Flanges

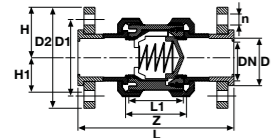

Çap Dia	Basınç PN	EPDM Conta Kod EPDM O-Ring Code	Fiyat (Adet) Price (Pcs)	Koli/Adet Box/Pcs	DN (mm)	Z (mm)	L1 (mm)	L (mm)	H (mm)	D1 (mm)	D2 (mm)	n (mm)
20	16	216 01 020 2		60	16	52	45	123	54	65	96	14x4
25	16	216 01 025 2		75	20	58	49	140	62	75	105	14x4
32	16	216 01 032 2		60	25	61	54	158	66	85	115	14x4
40	16	216 01 040 2		32	32	73	66	186	84	100	140	14x4
50	16	216 01 050 2		24	40	82	75	231	92	100	150	18x4
63	16	216 01 063 2		13	50	95	89	253	116	125	165	18x4
75	16	216 01 075 2		9	65	118	111	291	146	145	185	18x4
90	16	216 01 090 2		4	80	139	126	353	178	160	200	18x8
110	16	216 01 110 2		2	100	165	153	431	210	180	220	18x8

U-PVC Yapıştırma Muflu Toplu Çekvalf

U-PVC Solvent Cement Ball Checkvalve

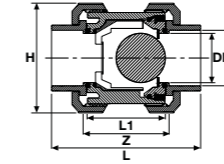

Çap Dia	Basınç PN	EPDM Conta Kod EPDM O-Ring Code	Fiyat (Adet) Price (Pcs)	Kg/Adet Kg/Pcs	Koli/Adet Box/Pcs	DN (mm)	H (mm)	L (mm)	L1 (mm)	Z (mm)
20	16	217 00 020 2		0,10	70	16	54	85	45	52
25	16	217 00 025 2		0,10	85	20	62	95	49	58
32	16	217 00 032 2		0,15	72	25	66	107	54	61
40	16	217 00 040 2		0,54	32	32	84	128	66	73
50	16	217 00 050 2		0,54	24	40	92	154	75	82
63	16	217 00 063 2		0,54	13	50	116	172	89	95
75	16	217 00 075 2				65	146	196	111	118
90	16	217 00 090 2				80	178	241	126	139
110	16	217 00 110 2				100	210	289	153	165

U-PVC Tek Taraf İçten Dişli Toplu Çekvalf

U-PVC One Side Female Threaded Ball Checkvalve

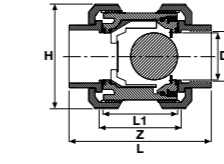

Çap Dia	Rp Inch	Basınç PN	EPDM Conta Kod EPDM O-Ring Code	Fiyat (Adet) Price (Pcs)	Kg/Adet Kg/Pcs	Koli/Adet Box/Pcs	DN (mm)	H (mm)	L (mm)	L1 (mm)	Z (mm)
16	3/8"	16	217 01 016 2		0,12	70	12	54	80	42	50
20	1/2"	16	217 01 020 2		0,10	70	16	54	85	45	52
25	3/4"	16	217 01 025 2		0,15	85	20	62	95	49	58
32	1"	16	217 01 032 2		0,19	72	25	66	107	54	61
40	1 1/4"	16	217 01 040 2		0,35	32	32	84	128	66	73
50	1 1/2"	16	217 01 050 2		0,54	24	40	92	154	75	82
63	2"	16	217 01 063 2		0,91	13	50	116	172	89	95

U-PVC Çift Taraf İçten Dişli Toplu Çekvalf

U-PVC Both Sides Female Threaded Ball Checkvalve

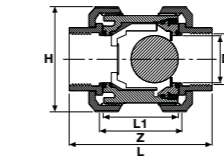

Rp Inch	Basınç PN	EPDM Conta Kod EPDM O-Ring Code	Fiyat (Adet) Price (Pcs)	Kg/Adet Kg/Pcs	Koli/Adet Box/Pcs	DN (mm)	H (mm)	L (mm)	L1 (mm)	Z (mm)
3/8"	16	217 02 016 2		0,12	70	12	54	80	42	50
1/2"	16	217 02 020 2		0,10	70	16	54	85	45	52
3/4"	16	217 02 025 2		0,15	85	20	62	95	49	58
1"	16	217 02 032 2		0,19	72	25	66	107	54	61
1 1/4"	16	217 02 040 2		0,35	32	32	84	128	66	73
1 1/2"	16	217 02 050 2		0,54	24	40	92	154	75	82
2"	16	217 02 063 2		0,91	13	50	116	172	89	95

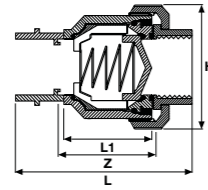
U-PVC Yapıştırma Mufllu Tek Taraflı Yaylı Çekvalf
 U-PVC Single Union Spring Checkvalve

Çap Dia	Basınç PN	EPDM Conta Kod EPDM O-Ring Code	Fiyat (Adet) Price (Pcs)	Kg/Adet Kg/Pcs	Koli/Adet Box/Pcs	DN (mm)	H (mm)	L (mm)	L1 (mm)	Z (mm)
20	16	214 10 020 2		0,09	60	16	47	47	45	55
25	16	214 10 025 2		0,16	75	20	52	52	49	59
32	16	214 10 032 2		0,20	60	25	63	63	54	69
40	16	214 10 040 2		0,45	32	32	66	66	66	72
50	16	214 10 050 2		0,54	20	40	89	89	75	91
63	16	214 10 063 2		0,95	13	50	100	100	89	103
75	16	214 10 075 2			9	65	146	128	111	111
90	16	214 10 090 2			4	80	178	227	125	141
110	16	214 10 110 2			2	100	210	275	155	171

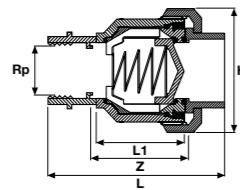
U-PVC Tek Taraf İç Dişli Tek Taraflı Yaylı Çekvalf
 U-PVC One Side Female Threaded Single Union Spring Checkvalve

Çap Dia	Rp Inch	Basınç PN	EPDM Conta Kod EPDM O-Ring Code	Fiyat (Adet) Price (Pcs)	Kg/Adet Kg/Pcs	Koli/Adet Box/Pcs	DN (mm)	H (mm)	L (mm)	L1 (mm)	Z (mm)
20	1/2"	16	215 10 020 2		0,09	60	16	47	47	45	55
25	3/4"	16	215 10 025 2		0,16	75	20	52	52	49	59
32	1"	16	215 10 032 2		0,20	60	25	63	63	54	69
40	1 1/4"	16	215 10 040 2		0,45	32	32	66	66	66	72
50	1 1/2"	16	215 10 050 2		0,54	20	40	89	89	75	91
63	2"	16	215 10 063 2		0,95	13	50	100	100	89	103
75	2 1/2"	16	215 10 075 2			9	65	146	128	111	111
90	3"	16	215 10 090 2			4	80	178	227	125	141
110	4"	16	215 10 110 2			2	100	210	275	155	171

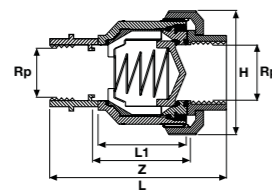
U-PVC Çift Taraf İç Dişli Tek Taraflı Yaylı Çekvalf
 U-PVC Both Sides Female Threaded Single Union Spring Checkvalve

Rp Inch	Basınç PN	EPDM Conta Kod EPDM O-Ring Code	Fiyat (Adet) Price (Pcs)	Kg/Adet Kg/Pcs	Koli/Adet Box/Pcs	DN (mm)	H (mm)	L (mm)	L1 (mm)	Z (mm)
1/2"	16	216 10 020 2		0,09	60	16	47	78	45	55
3/4"	16	216 10 025 2		0,16	75	20	52	87	49	59
1"	16	216 10 032 2		0,20	60	25	63	100	54	69
1 1/4"	16	216 10 040 2		0,45	32	32	66	114	66	72
1 1/2"	16	216 10 050 2		0,54	20	40	89	140	75	91
2"	16	216 10 063 2		0,95	13	50	100	163	89	103
2 1/2"	16	216 10 075 2			9	65	146	196	111	111
3"	16	216 10 090 2			4	80	178	227	125	141
4"	16	216 10 110 2			2	100	210	275	155	171

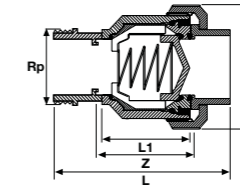
U-PVC Tek Taraf Dış Dişli Tek Taraflı Yaylı Çekvalf
 U-PVC One Side Male Threaded Single Union Spring Checkvalve

Çap Dia	Rp Inch	Basınç PN	EPDM Conta Kod EPDM O-Ring Code	Fiyat (Adet) Price (Pcs)	Kg/Adet Kg/Pcs	Koli/Adet Box/Pcs	DN (mm)	H (mm)	L (mm)	L1 (mm)	Z (mm)
20	1/2"	16	215 20 020 2		0,09	60	16	47	78	45	55
25	3/4"	16	215 20 025 2		0,16	75	20	52	87	49	59
32	1"	16	215 20 032 2		0,20	60	25	63	100	54	69
40	1 1/4"	16	215 20 040 2		0,45	32	32	66	114	66	72
50	1 1/2"	16	215 20 050 2		0,54	20	40	89	140	75	91
63	2"	16	215 20 063 2		0,95	13	50	100	163	89	103
75	2 1/2"	16	215 20 075 2			9	65	146	196	111	111
90	3"	16	215 20 090 2			4	80	178	227	125	141
110	4"	16	215 20 110 2			2	100	210	275	155	171

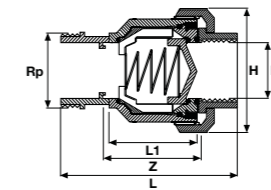
U-PVC Tek Taraf Dış Dişli Tek Taraf İç Dişli Yaylı Çekvalf
 U-PVC One Side Male Threaded One Side Female Threaded Single Union Spring Checkvalve

Çap Dia	Rp Inch	Basınç PN	EPDM Conta Kod EPDM O-Ring Code	Fiyat (Adet) Price (Pcs)	Kg/Adet Kg/Pcs	Koli/Adet Box/Pcs	DN (mm)	H (mm)	L (mm)	L1 (mm)	Z (mm)
20	1/2"	16	216 20 020 2		0,09	60	16	47	78	45	55
25	3/4"	16	216 20 025 2		0,16	75	20	52	87	49	59
32	1"	16	216 20 032 2		0,20	60	25	63	100	54	69
40	1 1/4"	16	216 20 040 2		0,45	32	32	66	114	66	72
50	1 1/2"	16	216 20 050 2		0,54	20	40	89	140	75	91
63	2"	16	216 20 063 2		0,95	13	50	100	163	89	103
75	2 1/2"	16	216 20 075 2			9	65	146	196	111	111
90	3"	16	216 20 090 2			4	80	178	227	125	141
110	4"	16	216 20 110 2			2	100	210	275	155	171

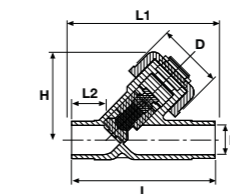
U-PVC Y Çekvalf
 U-PVC Angle Seat Valve

Çap Dia	Basınç PN	EPDM Conta Kod EPDM O-Ring Code	Fiyat (Adet) Price (Pcs)	Kg/Adet Kg/Pcs	Koli/Adet Box/Pcs	DN (mm)	D (mm)	L (mm)	L1 (mm)	L2 (mm)	H (mm)
20	16	222 00 020 4		0,13	1	15	43	124	130	28	65
25	16	222 00 025 4		0,20	1	20	47	144	150	37	75
32	16	222 00 032 4		0,32	1	25	56	154	160	37	90
40	16	222 00 040 4		0,49	1	32	64	174	180	44	102
50	16	222 00 050 4		0,86	1	40	82	194	200	48	123
63	16	222 00 063 4		1,45	1	50	95	224	230	60	144
75	16	222 00 075 4		2,49	1	65	92	284	290	74	186
90	16	222 00 090 4		3,51	1	80	104	300	310	85	204

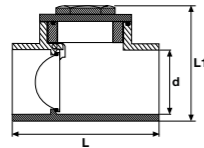
U-PVC Yapıştırma Muflu T Çekvalf
 U-PVC T Checkvalve

Su için / For Water

Asit için / For Acid

Çap Dia	Basınç PN	FPM Conta Kod FPM O-Ring Code	Fiyat (Adet) Price (Pcs)	FPM Conta Kod FPM O-Ring Code	Fiyat (Adet) Price (Pcs)	Kg/Adet Kg/Pcs	Koli/Adet Box/Pcs	DN (mm)	L (mm)	L1 (mm)
50	10	218 00 050 2		218 01 050 2		0,30	40	40	124	96
63	10	218 00 063 2		218 01 063 2		0,46	22	50	144	112
75	10	218 00 075 2		218 01 075 2			10	65	168	140
90	10	218 00 090 2		218 01 090 2			10	80	195	161

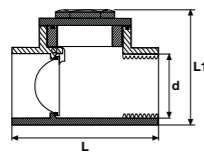
U-PVC Tek Taraf İç Dişli T Çekvalf
 U-PVC One Side Female Threaded T Check Valve

Su için / For Water

Asit için / For Acid

Çap Dia	DN (mm)	Basınç PN	FPM Conta Kod FPM O-Ring Code	Fiyat (Adet) Price (Pcs)	FPM Conta Kod FPM O-Ring Code	Fiyat (Adet) Price (Pcs)	Kg/Adet Kg/Pcs	Koli/Adet Box/Pcs	L (mm)	L1 (mm)
50	1 1/2"	10	219 00 050 2		219 01 050 2		0,32	40	124	96
63	2"	10	219 00 063 2		219 01 063 2		0,49	22	144	112
75	2 1/2"	10	219 00 075 2		219 01 075 2				168	140
90	3"	10	219 00 090 2		219 01 090 2				195	161

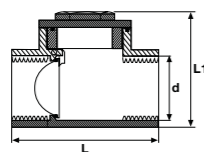
U-PVC Çift Taraf İç Dişli T Çekvalf
 U-PVC Both Side Female Threaded T Check Valve

Su için / For Water

Asit için / For Acid

Rp Inch	Basınç PN	FPM Conta Kod FPM O-Ring Code	Fiyat (Adet) Price (Pcs)	FPM Conta Kod FPM O-Ring Code	Fiyat (Adet) Price (Pcs)	Kg/Adet Kg/Pcs	Koli/Adet Box/Pcs	L (mm)	L1 (mm)
1 1/2"	10	219 10 050 2		219 11 050 2		0,30	40	124	96
2"	10	219 10 063 2		219 11 063 2		0,46	22	144	112
2 1/2"	10	219 10 075 2		219 11 075 2				168	140
3"	10	219 10 090 2		219 11 090 2				195	161

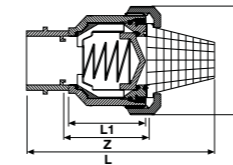
U-PVC Tek Taraf Rakorlu Kuyu Çekvalfi
 U-PVC Single Union Foot Checkvalve

Çap Dia	Basınç PN	EPDM Conta Kod EPDM O-Ring Code	Fiyat (Adet) Price (Pcs)	Kg/Adet Kg/Pcs	Koli/Adet Box/Pcs	DN (mm)	H (mm)	L (mm)	L1 (mm)	Z (mm)
20	16	214 30 020 2			60	16	47	108	45	55
25	16	214 30 025 2			75	20	52	115	49	59
32	16	214 30 032 2			60	25	63	140	54	69
40	16	214 30 040 2			32	32	66	160	66	72
50	16	214 30 050 2			24	40	89	180	75	91
63	16	214 30 063 2			13	50	100	220	89	103
75	16	214 30 075 2			9	65	146	270	111	111
90	16	214 30 090 2			4	80	178	335	125	141
110	16	214 30 110 2			2	100	210	345	155	171

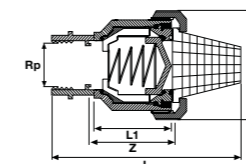
U-PVC Tek Taraf Rakorlu İç Dişli Kuyu Çekvalfi
 U-PVC Single Union Female Threaded Foot Checkvalve

Rp Inch	Basınç PN	EPDM Conta Kod EPDM O-Ring Code	Fiyat (Adet) Price (Pcs)	Kg/Adet Kg/Pcs	Koli/Adet Box/Pcs	DN (mm)	H (mm)	L (mm)	L1 (mm)	Z (mm)
1/2"	16	215 30 020 2			60	16	47	108	45	55
3/4"	16	215 30 025 2			75	20	52	115	49	59
1"	16	215 300 32 2			60	25	63	140	54	69
1 1/4"	16	215 300 40 2			32	32	66	160	66	72
1 1/2"	16	215 300 50 2			24	40	89	180	75	91
2"	16	215 300 63 2			13	50	100	220	89	103
2 1/2"	16	215 300 75 2			9	65	146	270	111	111
3"	16	215 300 90 2			4	80	178	335	125	141
4"	16	215 30 110 2			2	100	210	345	155	171

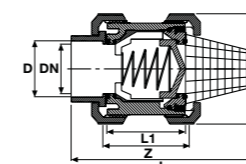
U-PVC Yapıştırma Muflu Kuyu Çekvalfi
 U-PVC Foot Spring Checkvalve

Çap Dia	Basınç PN	EPDM Conta Kod EPDM O-Ring Code	Fiyat (Adet) Price (Pcs)	Kg/Adet Kg/Pcs	Koli/Adet Box/Pcs	DN (mm)	H (mm)	L (mm)	L1 (mm)	Z (mm)
20	16	217 03 020 2			55	16	54	108	48	55
25	16	217 03 025 2			60	20	62	115	52	60
32	16	217 03 032 2			60	25	66	140	56	64
40	16	217 03 040 2			32	32	84	160	70	77
50	16	217 03 050 2			24	40	92	180	77	84
63	16	217 03 063 2			13	50	116	220	90	98
75	16	217 03 075 2			9	65	146	270	102	111
90	16	217 03 090 2			4	80	178	335	128	141
110	16	217 03 110 2			2	100	210	345	159	171

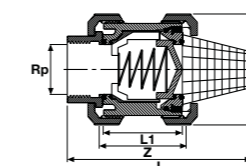
U-PVC İçten Dişli Kuyu Çekvalfi
 U-PVC Female Threaded Spring Foot Checkvalve

Rp Inch	Basınç PN	EPDM Conta Kod EPDM O-Ring Code	Fiyat (Adet) Price (Pcs)	Kg/Adet Kg/Pcs	Koli/Adet Box/Pcs	DN (mm)	H (mm)	L (mm)	L1 (mm)	Z (mm)
1/2"	16	217 04 020 2			60	16	54	108	48	55
3/4"	16	217 04 025 2			75	20	62	115	52	60
1"	16	217 04 032 2			60	25	66	140	56	64
1 1/4"	16	217 04 040 2			32	32	84	160	70	77
1 1/2"	16	217 04 050 2			24	40	92	180	77	84
2"	16	217 04 063 2			13	50	116	220	90	98
2 1/2"	16	217 04 075 2			9	65	146	270	102	111
3"	16	217 04 090 2			4	80	178	335	128	141
4"	16	217 04 110 2			2	100	210	345	159	171

U-PVC Atık Su Çekvalfi
Anti-Flooding Valve

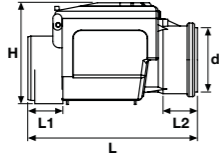

Çap Dia	Basınç PN	Kod Code	Fiyat (Adet) Price (Pcs)	Kg/Adet Kg/Pcs	Koli/Adet Box/Pcs	H (mm)	L (mm)	L1 (mm)	L2 (mm)
110	10	533 00 100 2		2,720	1	255	366	59	56
125	10	533 00 125 2		2,780	1	255	388	69	69
160	10	533 00 150 2		2,880	1	255	442	96	93

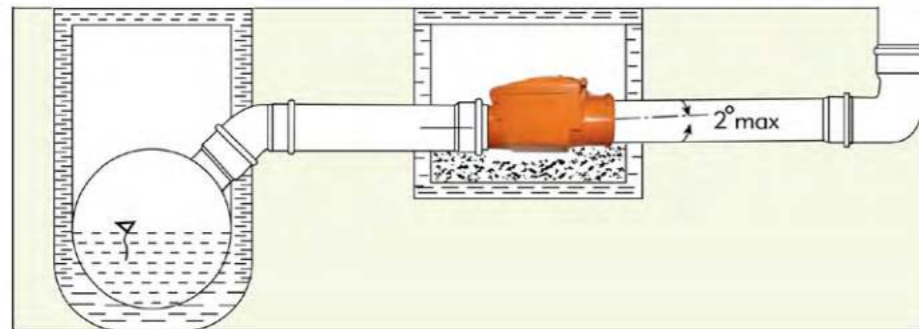
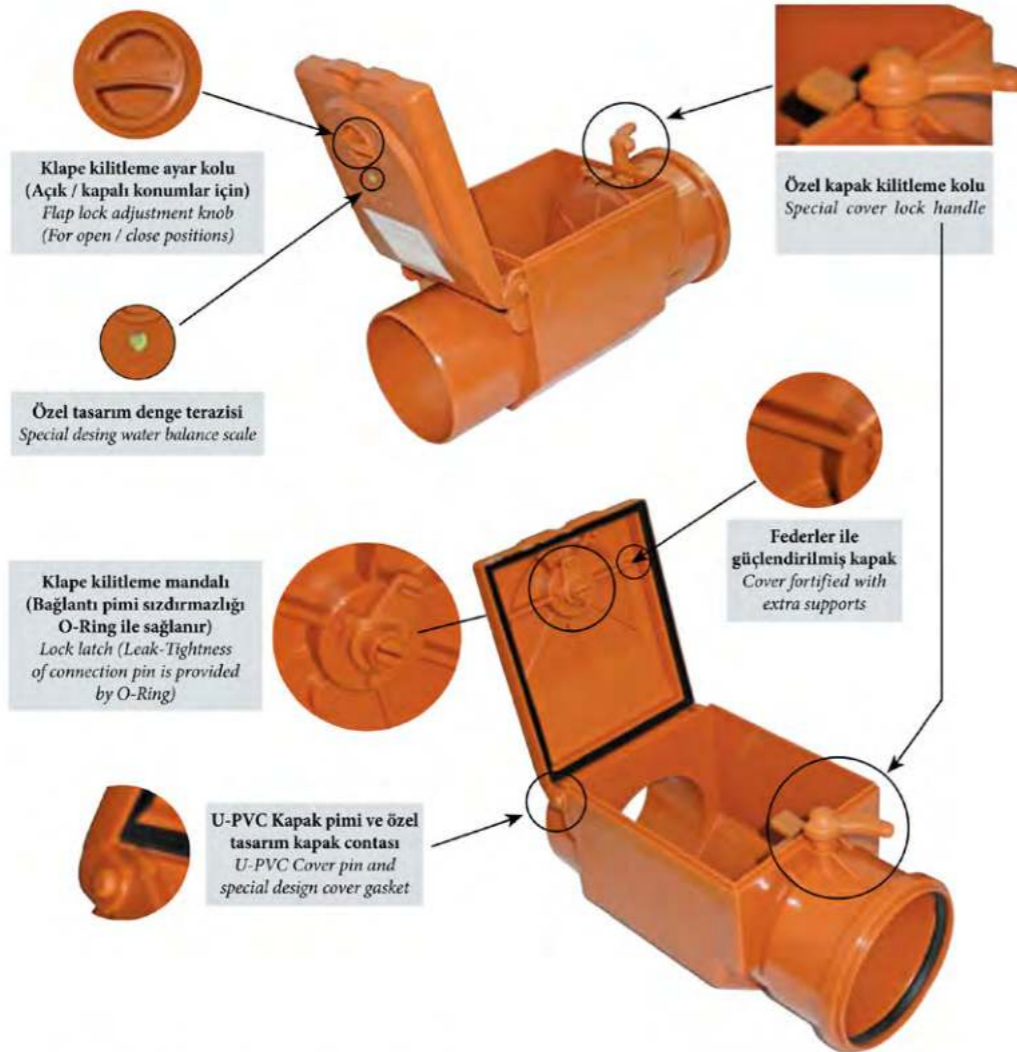

U-PVC

KELEBEK VANA

BUTTERFLY VALVES

ÜRETİM STANDARDI
PRODUCTION STANDARD | TS EN ISO 16136

ÇAP / SIZE Ø63 - Ø400



U-PVC Kelebek Vana (Çıplak)
U-PVC Butterfly Valve (Without Flange)

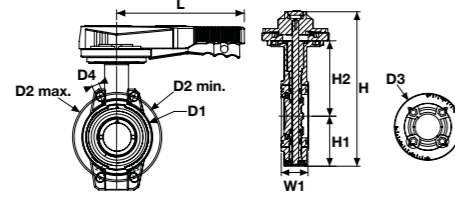

Su İçin / For Water

Asit İçin / For Acid

Çap Dia	Basınç PN	EPDM Conta Kod EPDM O-Ring Code	Fiyat (Adet) Price (Pcs)	FPM Conta Kod FPM O-Ring Code	Fiyat (Adet) Price (Pcs)	Kg /Adet Kg/Pcs	Koli/Ad. Box/Pcs
63	10	201 00 063 4		201 01 063 4		1,18	1
75	10	201 00 075 4		201 01 075 4		1,26	1
90	10	201 00 090 4		201 01 090 4		1,42	1
110	10	201 00 110 4		201 01 110 4		2,23	1
125	10	201 00 125 4		201 01 125 4		2,77	1
140	10	201 00 140 4		201 01 140 4		2,77	1
160	10	201 00 160 4		201 01 160 4		3,22	1
200	10	201 00 200 4		201 01 200 4		5,12	1
225	10	201 00 225 4		201 01 225 4		5,12	1
250	10	201 00 250 4		201 01 250 4		9,14	1
280	10	201 00 280 4		201 01 280 4		9,14	1
315	10	201 00 315 4		201 01 315 4		24,3	1
*355	6	201 00 355 4		201 01 355 4		?	1
*400	6	201 00 400 4		201 01 400 4		?	1

Çap Dia	DN	D1 (mm)	D2 min. (mm)	D2 max. (mm)	D3 (mm)	D4 (mm)	L (mm)	H (mm)	H1 (mm)	H2 (mm)	W1 (mm)	nØe	kv-value l/min.	ISO 5211 ISO 5211
63	50	104	120	125	115	19	207	256	82	126	45	4 x 19	1470	F 07
75	65	115	140	145	115	19	207	265	86	129	46	4 x 19	2200	F 07
90	80	131	150	160	115	19	207	272	89	132	48	8 x 19	3000	F 07
110	100	160	175	190	115	19	207	311	103	156	56	8 x 19	6500	F 07
125	110	190	210	216	115	23	258	338	116	169	63	8 x 23	11500	F 07
140	125	190	210	216	115	23	258	338	116	169	63	8 x 23	11500	F 07
160	150	214	241	241	115	24	258	364	129	182	66	8 x 24	16600	F 07
200	175	268	290	295	115	24	335	414	158	203	75	8 x 24	39600	F 07
225	200	268	290	295	115	24	335	414	158	203	75	8 x 24	39600	F 07
250	250	333	353	362	156	24	410	507	198	242	114	8 x 24	55200	F 10
280	250	333	353	362	156	24	410	507	198	242	114	12 x 24	55200	F 10
315	300	379	400	432	156	24	410	580	228	285	113	12 x 24	80000	F 10
*355	350	535	445	477	156	26	410	620	268	305	140	16 x 24	90000	F 12
*400	400	595	510	540	156	26	410	686	285	335	168	16 x 26	115000	F 12

* Redüktör Dişli Kelebek Vana / Reduction Gear Butterfly Valve

U-PVC Flanşlı Kelebek Vana (Takım)
U-PVC Butterfly Valve With Flange Adaptor

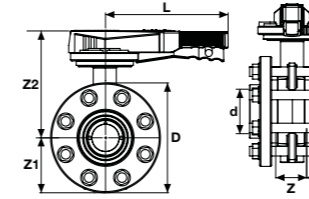

Su İçin / For Water

Asit İçin / For Acid

Çap Dia	Basınç PN	EPDM Conta Kod EPDM O-Ring Code	Fiyat (Adet) Price (Pcs)	FPM Conta Kod FPM O-Ring Code	Fiyat (Adet) Price (Pcs)	Kg /Adet Kg/Pcs	Koli/Ad. Box/Pcs
63	10	200 00 063 2		200 01 063 4		3,00	1
75	10	200 00 075 2		200 01 075 4		5,00	1
90	10	200 00 090 2		200 01 090 4		6,60	1
110	10	200 00 110 2		200 01 110 4		6,60	1
125	10	200 00 125 2		200 01 125 4		9,50	1
140	10	200 00 140 2		200 01 140 4		9,90	1
160	10	200 00 160 2		200 01 160 4		11,4	1
200	10	200 00 200 2		200 01 200 4		17,1	1
225	10	200 00 225 2		200 01 225 4		36,7	1
250	10	200 00 250 2		200 01 250 4		36,7	1
280	10	200 00 280 2		200 01 280 4		39,2	1
315	10	200 00 315 2		200 01 315 4		44,5	1
*355	6	200 00 355 2		200 01 355 4			1
*400	6	200 00 400 2		200 01 400 4			1

304 Paslanmaz Civata-Somun-Pul / 304.S.S.Screw,Nut,Washer

Su İçin / For Water

Asit İçin / For Acid

Çap Dia	EPDM Conta Kod EPDM O-Ring Code	Fiyat (Adet) Price (Pcs)	FPM Conta Kod FPM O-Ring Code	Fiyat (Adet) Price (Pcs)
63	200 02 063 4		200 03 063 4	
75	200 02 075 4		200 03 075 4	
90	200 02 090 4		200 03 090 4	
110	200 02 110 4		200 03 110 4	
125	200 02 125 4		200 03 125 4	
140	200 02 140 4		200 03 140 4	
160	200 02 160 4		200 03 160 4	
200	200 02 200 4		200 03 200 4	
225	200 02 225 4		200 03 225 4	
250	200 02 250 4		200 03 250 4	
280	200 02 280 4		200 03 280 4	
315	200 02 315 4		200 03 315 4	
355	200 02 355 4		200 03 355 4	
400	200 02 400 4		200 03 400 4	

316 Paslanmaz Civata-Somun-Pul / 316.S.S.Screw,Nut,Washer

Su İçin / For Water

Asit İçin / For Acid

Çap Dia	EPDM Conta Kod EPDM O-Ring Code	Fiyat (Adet) Price (Pcs)	FPM Conta Kod FPM O-Ring Code	Fiyat (Adet) Price (Pcs)
63	200 04 063 4		200 05 063 4	
75	200 04 075 4		200 05 075 4	
90	200 04 090 4		200 05 090 4	
110	200 04 110 4		200 05 110 4	
125	200 04 125 4		200 05 125 4	
140	200 04 140 4		200 05 140 4	
160	200 04 160 4		200 05 160 4	
200	200 04 200 4		200 05 200 4	
225	200 04 225 4		200 05 225 4	
250	200 04 250 4		200 05 250 4	
280	200 04 280 4		200 05 280 4	
315	200 04 315 4		200 05 315 4	
355	200 04 355 4		200 05 355 4	
400	200 04 400 4		200 05 400 4	

Çap Dia	DN	D (mm)	Z (mm)	Z1 (mm)	Z2 (mm)	B (mm)	L (mm)	Q1 (mm)	Q2 (mm)	nØe	ISO 5211 ISO 5211	kv-value l/min.	Basınç PN	Kg /Adet Kg/Pcs	Koli/Ad. Box/Pcs
63	50	165	51	82	188	38	207	37		4 x 19	F 07	1470	10	3,00	1
75	65	185	52	92	180	43	207	50	40	4 x 19	F 07	2200	10	5,00	1
90	80	200	58	100	183	51	207	65	46	8 x 19	F 07	3000	10	6,60	1
110	100	220	66	110	208	60	258	85	68	8 x 19	F 07	6500	10	6,60	1
125	110	250	73	125	221	69	258	111	92	8 x 23	F 07	11500	10	9,50	1
140	125	250	73	125	221	75	258	111	92	8 x 23	F 07	11500	10	9,90	1
160	150	285	76	142	235	86	258	138	122	8 x 24	F 07	16600	10	11,4	1
200	175	340	87	170	255	106	335	192	179	8 x 24	F 07	39600	10	17,1	1
225	200	340	87	170	255	120	335	192	179	8 x 24	F 07	39600	10	36,7	1
250	250	395	123	198	309	131	410	223	209	8 x 24	F 10	55200	10	36,7	1
280	250	395	119	198	309	146	410	223	209	12 x 24	F 10	55200	10	39,2	1
315	300	445	121	228	370	164	410	256	253	12 x 24	F 10	80000	10	44,5	1
*355	350	505	140	255	372	185	410	325	305	16 x 24	F 12	90000	6		1
*400	400	565	169	285	402	206	410	353	350	16 x 26	F 12	115000	6		1

* Redüktör Dişli Kelebek Vana / Reduction Gear Butterfly Valve

U-PVC Redüktör Dişli Kelebek Vana (Çıplak)

U-PVC Reduction Gear Butterfly Valve With Handwheel (Without Flange)

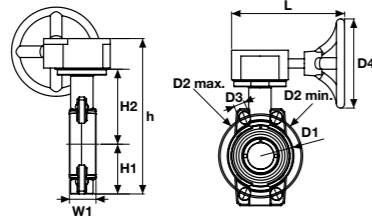

Su İçin / For Water

Asit İçin / For Acid

Çap Dia	Basınç PN	EPDM Conta Kod EPDM O-Ring Code	Fiyat (Adet) Price (Pcs)	FPM Conta Kod FPM O-Ring Code	Fiyat (Adet) Price (Pcs)	Kg /Adet Kg/Pcs	Koli/Ad. Box/Pcs
63	10	201 11 063 4		201 02 063 4			1
75	10	201 11 075 4		201 02 075 4			1
90	10	201 11 090 4		201 02 090 4			1
110	10	201 11 110 4		201 02 110 4			1
125	10	201 11 125 4		201 02 125 4			1
140	10	201 11 140 4		201 02 140 4			1
160	10	201 11 160 4		201 02 160 4			1
200	10	201 11 200 4		201 02 200 4			1
225	10	201 11 225 4		201 02 225 4			1
250	10	201 11 250 4		201 02 250 4			1
280	10	201 11 280 4		201 02 280 4			1
315	10	201 11 315 4		201 02 315 4			1
355	6	201 11 355 4		201 02 355 4			1
400	6	201 11 400 4		201 02 400 4			1

Çap Dia	DN	D1 (mm)	D2 min. (mm)	D2 max. (mm)	D3 (mm)	D4 (mm)	L (mm)	H (mm)	H1 (mm)	H2 (mm)	W1 (mm)	nØe	kv-value l/min.	ISO 5211 ISO 5211
63	50	104	120	125	115	19	192	279	82	126	45	4 x 19	1470	F 07
75	65	115	140	145	115	19	192	288	86	129	46	4 x 19	2200	F 07
90	80	131	150	160	115	19	192	290	89	132	48	8 x 19	3000	F 07
110	100	160	175	190	115	19	192	337	103	156	56	8 x 19	6500	F 07
125	110	190	210	216	115	23	192	353	116	169	63	8 x 23	11500	F 07
140	125	190	210	216	115	23	192	353	116	169	63	8 x 23	11500	F 07
160	150	214	241	241	115	24	192	375	129	182	66	8 x 24	16600	F 07
200	175	268	290	295	115	24	192	429	158	203	75	8 x 24	39600	F 07
225	200	268	290	295	115	24	192	429	158	203	75	8 x 24	39600	F 07
250	250	333	353	362	156	24	250	485	198	242	114	8 x 24	55200	F 10
280	250	333	353	362	156	24	250	485	198	242	114	12 x 24	55200	F 10
315	300	379	400	432	156	24	250	581	228	285	113	12 x 24	80000	F 10
355	350	535	445	477	156	26	250	581	268	305	140	16 x 24	90000	F 12
400	400	595	510	540	156	26	250	581	285	335	168	16 x 26	115000	F 12

U-PVC Redüktör Dişli Flanşlı Kelebek Vana (Takım)

U-PVC Reduction Gear Butterfly Valve With Handwheel and Flange

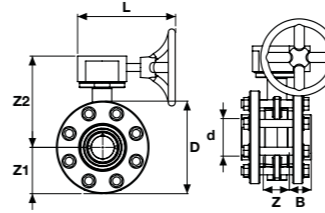

Su İçin / For Water

Asit İçin / For Acid

Çap Dia	Basınç PN	EPDM Conta Kod EPDM O-Ring Code	Fiyat (Adet) Price (Pcs)	FPM Conta Kod FPM O-Ring Code	Fiyat (Adet) Price (Pcs)	Kg /Adet Kg/Pcs	Koli/Ad. Box/Pcs
63	10	201 03 063 4		201 09 063 4		3,00	1
75	10	201 03 075 4		201 09 075 4		3,60	1
90	10	201 03 090 4		201 09 090 4		5,45	1
110	10	201 03 110 4		201 09 110 4		6,60	1
125	10	201 03 125 4		201 09 125 4		9,50	1
140	10	201 03 140 4		201 09 140 4		9,90	1
160	10	201 03 160 4		201 09 160 4		11,4	1
200	10	201 03 200 4		201 09 200 4		17,1	1
225	10	201 03 225 4		201 09 225 4		17,1	1
250	10	201 03 250 4		201 09 250 4		36,7	1
280	10	201 03 280 4		201 09 280 4			1
315	10	201 03 315 4		201 09 315 4		44,5	1
355	6	201 03 355 4		201 09 355 4			1
400	6	201 03 400 4		201 09 400 4			1

304 Paslanmaz Civata-Somun-Pul / 304.S.S.Screw,Nut,Washer

Su İçin / For Water

Asit İçin / For Acid

Çap Dia	EPDM Conta Kod EPDM O-Ring Code	Fiyat (Adet) Price (Pcs)	FPM Conta Kod FPM O-Ring Code	Fiyat (Adet) Price (Pcs)
63	201 05 063 4		201 06 063 4	
75	201 05 075 4		201 06 075 4	
90	201 05 090 4		201 06 090 4	
110	201 05 110 4		201 06 110 4	
125	201 05 125 4		201 06 125 4	
140	201 05 140 4		201 06 140 4	
160	201 05 160 4		201 06 160 4	
200	201 05 200 4		201 06 200 4	
225	201 05 225 4		201 06 225 4	
250	201 05 250 4		201 06 250 4	
280	201 05 280 4		201 06 280 4	
315	201 05 315 4		201 06 315 4	
355	201 05 355 4		201 06 355 4	
400	201 05 400 4		201 06 400 4	

316 Paslanmaz Civata-Somun-Pul / 316.S.S.Screw,Nut,Washer

Su İçin / For Water

Asit İçin / For Acid

Çap Dia	EPDM Conta Kod EPDM O-Ring Code	Fiyat (Adet) Price (Pcs)	FPM Conta Kod FPM O-Ring Code	Fiyat (Adet) Price (Pcs)
63	201 07 063 4		201 08 063 4	
75	201 07 075 4		201 08 075 4	
90	201 07 090 4		201 08 090 4	
110	201 07 110 4		201 08 110 4	
125	201 07 125 4		201 08 125 4	
140	201 07 140 4		201 08 140 4	
160	201 07 160 4		201 08 160 4	
200	201 07 200 4		201 08 200 4	
225	201 07 225 4		201 08 225 4	
250	201 07 250 4		201 08 250 4	
280	201 07 280 4		201 08 280 4	
315	201 07 315 4		201 08 315 4	
355	201 07 355 4		201 08 355 4	
400	201 07 400 4		201 08 400 4	

Çap Dia	DN	D (mm)	Z (mm)	Z1 (mm)	Z2 (mm)	B (mm)	L (mm)	Q1 (mm)	Q2 (mm)	nØe	ISO 5211 ISO 5211	kv-value l/min.
63	50	165	51	82	196	38	192	37		4 x 19	F 07	1470
75	65	185	52	92	191	43	192	50	40	4 x 19	F 07	2200
90	80	200	58	100	190	51	192	65	46	8 x 19	F 07	3000
110	100	220	66	110	227	60	192	85	68	8 x 19	F 07	6500
125	110	250	73	125	228	69	192	111	92	8 x 23	F 07	11500
140	125	250	73	125	228	75	192	111	92	8 x 23	F 07	11500
160	150	285	76	142	232	86	192	138	122	8 x 24	F 07	16600
200	175	340	87	170	259	106	192	192	179	8 x 24	F 07	39600
225	200	340	87	170	259	120	192	192	179	8 x 24	F 07	39600
250	250	395	123	198	287	131	250	223	209	8 x 24	F 10	55200
280	250	395	119	198	287	146	250	223	209	12 x 24	F 10	55200
315	300	445	121	228	353	164	250	256	253	12 x 24	F 10	80000
355	350	505	140	255	372	185	300	325	305	16 x 24	F 12	90000
400	400	565	169	285	402	206	300	353	350	16 x 26	F 12	115000

Not / Note

U-PVC

AKTÜATÖRLÜ KELEBEK VANA ACTUATOR BUTTERFLY VALVE

ÜRETİM STANDARDI

PRODUCTION STANDARD

TS EN ISO 16136

ÇAP / SIZE Ø20 - Ø400



 **PIMTA5**[®]

Since 1977

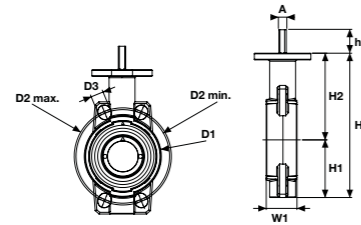
U-PVC Aktüatör Uyumlu Kelebek Vana (Çıplak)
 U-PVC Actuator Mountable Butterfly Valves (Without Flange)

Su İçin / For Water
Asit İçin / For Acid

Çap Dia	Basınç PN	EPDM Conta Kod EPDM O-Ring Code	Fiyat (Adet) Price (Pcs)	FPM Conta Kod FPM O-Ring Code	Fiyat (Adet) Price (Pcs)	Kg /Adet Kg/Pcs	Koli/Ad. Box/Pcs
63	10	300 00 063 4		300 01 063 4		0,89	1
75	10	300 00 075 4		300 01 075 4			1
90	10	300 00 090 4		300 01 090 4			1
110	10	300 00 110 4		300 01 110 4			1
125	10	300 00 125 4		300 01 125 4			1
140	10	300 00 140 4		300 01 140 4			1
160	10	300 00 160 4		300 01 160 4			1
200	10	300 00 200 4		300 01 200 4			1
225	10	300 00 225 4		300 01 225 4			1
250	10	300 00 250 4		300 01 250 4		30,5	1
280	10	300 00 280 4		300 01 280 4			1
315	10	300 00 315 4		300 01 315 4			1
355	6	300 00 355 4		300 01 355 4			1
400	6	300 00 400 4		300 01 400 4			1

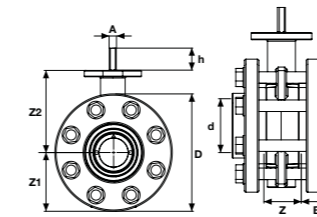
Çap Dia	DN (mm)	D1 (mm)	D2 min. (mm)	D2 max. (mm)	D3 (mm)	H (mm)	H1 (mm)	H2 (mm)	W1 (mm)	A (mm)	h (mm)	nØe	kv-value l/min.	ISO 5211 ISO 5211
63	50	104	120	125	19	256	82	126	45	11	15	4 x 19	1470	F 07
75	65	115	140	145	19	265	86	129	46	11	15	4 x 19	2200	F 07
90	80	131	150	160	19	272	89	132	48	11	15	8 x 19	3000	F 07
110	100	160	175	190	19	311	103	156	56	14	15	8 x 19	6500	F 07
125	110	190	210	216	23	338	116	169	63	14	15	8 x 23	11500	F 07
140	125	190	210	216	23	338	116	169	63	14	15	8 x 23	11500	F 07
160	150	214	241	241	24	364	129	182	66	14	15	8 x 24	16600	F 07
200	175	268	290	295	24	414	158	203	75	17	15	8 x 24	39600	F 07
225	200	268	290	295	24	414	158	203	75	17	15	8 x 24	39600	F 07
250	250	333	353	362	24	507	198	242	114	17	20	8 x 24	55200	F 10
280	250	333	353	362	24	507	198	242	114	17	20	12 x 24	55200	F 10
315	300	379	400	432	24	580	228	285	113	22	20	12 x 24	80000	F 10
355	350	535	445	477	26	620	268	305	140	22	20	16 x 24	90000	F 12
400	400	595	510	540	26	686	285	335	168	22	20	16 x 26	115000	F 12

U-PVC Aktüatör Uyumlu Kelebek Vana (Takım)
 U-PVC Actuator Mountable Butterfly Valves (With Flange Adaptor)

Su İçin / For Water
Asit İçin / For Acid

Çap Dia	Basınç PN	EPDM Conta Kod EPDM O-Ring Code	Fiyat (Adet) Price (Pcs)	FPM Conta Kod FPM O-Ring Code	Fiyat (Adet) Price (Pcs)	Kg /Adet Kg/Pcs	Koli/Ad. Box/Pcs
63	10	301 00 063 4		301 01 063 4			1
75	10	301 00 075 4		301 01 075 4			1
90	10	301 00 090 4		301 01 090 4			1
110	10	301 00 110 4		301 01 110 4			1
125	10	301 00 125 4		301 01 125 4			1
140	10	301 00 140 4		301 01 140 4			1
160	10	301 00 160 4		301 01 160 4			1
200	10	301 00 200 4		301 01 200 4			1
225	10	301 00 225 4		301 01 225 4			1
250	10	301 00 250 4		301 01 250 4			1
280	10	301 00 280 4		301 01 280 4			1
315	10	301 00 315 4		301 01 315 4			1
355	6	301 00 355 4		301 01 355 4			1
400	6	301 00 400 4		301 01 400 4			1

304 Paslanmaz Civata-Somun-Pul / 304.S.S.Screw,Nut,Washer
Su İçin / For Water
Asit İçin / For Acid

Çap Dia	EPDM Conta Kod EPDM O-Ring Code	Fiyat (Adet) Price (Pcs)	FPM Conta Kod FPM O-Ring Code	Fiyat (Adet) Price (Pcs)
63	308 00 063 2		308 10 063 2	
75	308 00 075 2		308 10 075 2	
90	308 00 090 2		308 10 090 2	
110	308 00 110 2		308 10 110 2	
125	308 00 125 2		308 10 125 2	
140	308 00 140 2		308 10 140 2	
160	308 00 160 2		308 10 160 2	
200	308 00 200 2		308 10 200 2	
225	308 00 225 2		308 10 225 2	
250	308 00 250 2		308 10 250 2	
280	308 00 280 2		308 10 280 2	
315	308 00 315 2		308 10 315 2	
355	308 00 355 2		308 10 355 2	
400	308 00 400 2		308 10 400 2	

316 Paslanmaz Civata-Somun-Pul / 316.S.S.Screw,Nut,Washer
Su İçin / For Water
Asit İçin / For Acid

Çap Dia	EPDM Conta Kod EPDM O-Ring Code	Fiyat (Adet) Price (Pcs)	FPM Conta Kod FPM O-Ring Code	Fiyat (Adet) Price (Pcs)
63	309 00 063 2		309 10 063 2	
75	309 00 075 2		309 10 075 2	
90	309 00 090 2		309 10 090 2	
110	309 00 110 2		309 10 110 2	
125	309 00 125 2		309 10 125 2	
140	309 00 140 2		309 10 140 2	
160	309 00 160 2		309 10 160 2	
200	309 00 200 2		309 10 200 2	
225	309 00 225 2		309 10 225 2	
250	309 00 250 2		309 10 250 2	
280	309 00 280 2		309 10 280 2	
315	309 00 315 2		309 10 315 2	
355	309 00 355 2		309 10 355 2	
400	309 00 400 2		309 10 400 2	

Çap Dia	DN (mm)	D (mm)	Z (mm)	Z1 (mm)	Z2 (mm)	B (mm)	Q1 (mm)	Q2 (mm)	A (mm)	h (mm)	nØe	ISO 5211 ISO 5211	kv-value l/min.
63	50	54	51	82	188	38	37	-	11	15	4 x 19	F 07	1470
75	65	57	52	92	180	43	50	40	11	15	4 x 19	F 07	2200
90	80	131	58	100	183	51	65	46	11	15	8 x 19	F 07	3000
110	100	160	66	110	208	60	85	68	14	15	8 x 19	F 07	6500
125	110	190	73	125	221	69	111	92	14	15	8 x 23	F 07	11500
140	125	190	73	125	221	75	111	92	14	15	8 x 23	F 07	11500
160	150	214	76	142	235	86	138	122	14	15	8 x 24	F 07	16600
200	175	268	87	170	255	106	192	179	17	15	8 x 24	F 07	39600
225	200	268	87	170	255	120	192	179	17	15	8 x 24	F 07	39600
250	250	333	123	198	309	131	223	209	17	20	8 x 24	F 10	55200
280	250	333	119	198	309	146	223	209	17	20	12 x 24	F 10	55200
315	300	379	121	228	370	164	256	253	22	20	12 x 24	F 10	80000
355	350	505	140	255	372	185	325	305	22	20	16 x 24	F 12	90000
400	400	565	169	285	402	206	353	350	22	20	16 x 26	F 12	115000

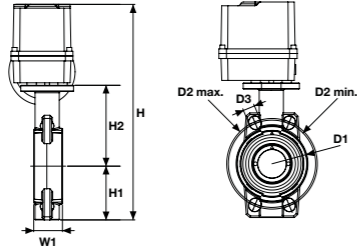
U-PVC Elektrik Aktüatörlü Kelebek Vana 24 V DC/24 V AC (Çıplak)
 U-PVC Butterfly Valve Electric Actuator 24 V DC/24 V AC (Without Flange)

Su için / For Water

Asit için / For Acid

Çap Dia	Basınç PN	EPDM Conta Kod EPDM O-Ring Code	Fiyat (Adet) Price (Pcs)	FPM Conta Kod FPM O-Ring Code	Fiyat (Adet) Price (Pcs)	Kg /Adet Kg/Pcs	Koli/Ad. Box/Pcs
63	10	302 00 063 4		302 01 063 4			1
75	10	302 00 075 4		302 01 075 4			1
90	10	302 00 090 4		302 01 090 4			1
110	10	302 00 110 4		302 01 110 4			1
125	10	302 00 125 4		302 01 125 4			1
140	10	302 00 140 4		302 01 140 4			1
160	10	302 00 160 4		302 01 160 4			1
200	10	302 00 200 4		302 01 200 4			1
225	10	302 00 225 4		302 01 225 4			1
250	10	302 00 250 4		302 01 250 4			1
280	10	302 00 280 4		302 01 280 4			1
315	10	302 00 315 4		302 01 315 4			1
355	6	302 00 355 4		302 01 355 4			1
400	6	302 00 400 4		302 01 400 4			1

Çap Dia	DN (mm)	D1 (mm)	D2 min. (mm)	D2 max. (mm)	D3 (mm)	H (mm)	H1 (mm)	H2 (mm)	W1 (mm)	nØe	kv-value l/min.	ISO 5211 ISO 5211
63	50	54	120	125	19	446	77	134	45	4 x 19	1470	F 07
75	65	57	140	145	19	451	86	129	46	4 x 19	2200	F 07
90	80	131	150	160	19	457	89	132	48	8 x 19	3000	F 07
110	100	160	175	190	19	504	103	156	56	8 x 19	6500	F 07
125	110	190	210	216	23	520	116	169	63	8 x 23	11500	F 07
140	125	190	210	216	23	520	116	169	63	8 x 23	11500	F 07
160	150	214	241	241	24	546	129	182	66	8 x 24	16600	F 07
200	175	268	290	295	24	596	158	203	75	8 x 24	39600	F 07
225	200	268	290	295	24	596	158	203	75	8 x 24	39600	F 07
250	250	333	341	362	24	748	198	242	114	8 x 24	55200	F 10
280	250	333	341	362	24	748	198	242	114	12 x 24	55200	F 10
315	300	379	400	432	25	923	228	285	113	12 x 24	80000	F 10
355	350	535	445	477	26	620	268	305	140	16 x 24	90000	F 12
400	400	595	510	540	26	686	285	335	168	16 x 26	115000	F 12

Opsiyonlar: Akülü açma/kapama emniyet kumandalı olabilir. Oransal kontrol ünitesi, potansiyometre, lokal kontrol ünitesi, pozisyon transmiyeri opsiyonları mevcuttur.

Boru flanş bağlantı ölçüleri: EN 1092 PN10, ISO 7005 PN10, ANSI B 16,5 class 150, BS 1560 1958

Aktüatör flanş bağlantı ölçüleri: ISO 5211/24V DC - 24V AC.

Options: Battery powered on/off can be safety controlled. Option control unit, potentiometer, local control unit, position transmitter options are available.

Pipe flange connection dimensions: EN 1092 PN10, ISO 7005 PN10, ANSI B 16,5 class 150, BS 1560 1958

Actuator flange connection measures: ISO 5211/24V DC - 24V AC.

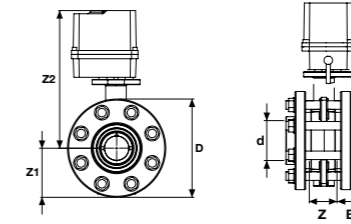
U-PVC Elektrik Aktüatörlü Kelebek Vana 24 V DC/24 V AC (Takım)
 U-PVC Butterfly Valve Electric Actuator 24 V DC/24 V AC (With Flange Adaptor)

Su için / For Water

Asit için / For Acid

Çap Dia	Basınç PN	EPDM Conta Kod EPDM O-Ring Code	Fiyat (Adet) Price (Pcs)	FPM Conta Kod FPM O-Ring Code	Fiyat (Adet) Price (Pcs)	Kg /Adet Kg/Pcs	Koli/Ad. Box/Pcs
63	10	304 00 063 4		304 01 063 4			1
75	10	304 00 075 4		304 01 075 4			1
90	10	304 00 090 4		304 01 090 4			1
110	10	304 00 110 4		304 01 110 4			1
125	10	304 00 125 4		304 01 125 4			1
140	10	304 00 140 4		304 01 140 4			1
160	10	304 00 160 4		304 01 160 4			1
200	10	304 00 200 4		304 01 200 4			1
225	10	304 00 225 4		304 01 225 4			1
250	10	304 00 250 4		304 01 250 4			1
280	10	304 00 280 4		304 01 280 4			1
315	10	304 00 315 4		304 01 315 4			1
355	6	304 00 355 4		304 01 355 4			1
400	6	304 00 400 4		304 01 400 4			1

Çap Dia	DN (mm)	D (mm)	Z (mm)	Z1 (mm)	Z2 (mm)	B (mm)	nØe	ISO 5211 ISO 5211
63	50	165	51	83	395	38	4 x 19	F 07
75	65	185	52	93	399	43	4 x 19	F 07
90	80	200	58	100	398	51	8 x 19	F 07
110	100	220	66	110	438	60	8 x 19	F 07
125	110	250	73	125	447	69	8 x 23	F 07
140	125	250	73	125	447	75	8 x 23	F 07
160	150	285	76	143	459	86	8 x 24	F 07
200	175	340	87	170	509	106	8 x 24	F 07
225	200	340	87	170	509	120	8 x 24	F 07
250	250	395	123	198	625	131	8 x 24	F 10
280	250	395	119	198	629	146	12 x 24	F 10
315	300	445	121	228	802	164	12 x 24	F 10
355	350	505	140	255	372	185	16 x 24	F 12
400	400	565	169	285	402	206	16 x 26	F 12

Opsiyonlar: Akülü açma/kapama emniyet kumandalı olabilir. Oransal kontrol ünitesi, potansiyometre, lokal kontrol ünitesi, pozisyon transmiyeri opsiyonları mevcuttur.

Boru flanş bağlantı ölçüleri: EN 1092 PN10, ISO 7005 PN10, ANSI B 16,5 class 150, BS 1560 1958

Aktüatör flanş bağlantı ölçüleri: ISO 5211/24V DC - 24V AC.

Options: Battery powered on/off can be safety controlled. Option control unit, potentiometer, local control unit, position transmitter options are available.

Pipe flange connection dimensions: EN 1092 PN10, ISO 7005 PN10, ANSI B 16,5 class 150, BS 1560 1958

Actuator flange connection measures: ISO 5211/24V DC - 24V AC.

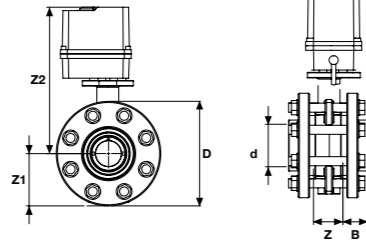
U-PVC Elektrik Aktüatörlü Kelebek Vana 24 V DC/24 V AC 304/316 Paslanmaz Civata-Somun-Pul
 U-PVC Butterfly Valves With Flange 304/316 S.S. Screw, Nut, Washer Electric Actuator 24 V DC/24 V AC

304 Paslanmaz Civata-Somun-Pul / 304.S.S.Screw,Nut,Washer

Çap Dia	Su için / For Water		Asit için / For Acid	
	EPDM Conta Kod EPDM O-Ring Code	Fiyat (Adet) Price (Pcs)	FPM Conta Kod FPM O-Ring Code	Fiyat (Adet) Price (Pcs)
63	306 00 063 4		306 01 063 4	
75	306 00 075 4		306 01 075 4	
90	306 00 090 4		306 01 090 4	
110	306 00 110 4		306 01 110 4	
125	306 00 125 4		306 01 125 4	
140	306 00 140 4		306 01 140 4	
160	306 00 160 4		306 01 160 4	
200	306 00 200 4		306 01 200 4	
225	306 00 225 4		306 01 225 4	
250	306 00 250 4		306 01 250 4	
280	306 00 280 4		306 01 280 4	
315	306 00 315 4		306 01 315 4	
355	306 00 355 4		306 01 355 4	
400	306 00 400 4		306 01 400 4	

316 Paslanmaz Civata-Somun-Pul / 316.S.S.Screw,Nut,Washer

Çap Dia	Su için / For Water		Asit için / For Acid	
	EPDM Conta Kod EPDM O-Ring Code	Fiyat (Adet) Price (Pcs)	FPM Conta Kod FPM O-Ring Code	Fiyat (Adet) Price (Pcs)
63	308 00 063 4		308 01 063 4	
75	308 00 075 4		308 01 075 4	
90	308 00 090 4		308 01 090 4	
110	308 00 110 4		308 01 110 4	
125	308 00 125 4		308 01 125 4	
140	308 00 140 4		308 01 140 4	
160	308 00 160 4		308 01 160 4	
200	308 00 200 4		308 01 200 4	
225	308 00 225 4		308 01 225 4	
250	308 00 250 4		308 01 250 4	
280	308 00 280 4		308 01 280 4	
315	308 00 315 4		308 01 315 4	
355	308 00 355 4		308 01 355 4	
400	308 00 400 4		308 01 400 4	

Çap Dia	DN (mm)	D (mm)	Z (mm)	Z1 (mm)	Z2 (mm)	B (mm)	Q1 (mm)	Q2 (mm)	nØe	ISO 5211 ISO 5211	Basınç PN	kv-value l/min.	Kg /Adet Kg/Pcs	Koli/Ad. Box/Pcs
63	50	165	51	82	395	38	37		4 x 19	F 07	10	1470		1
75	65	185	52	92	399	43	50	40	4 x 19	F 07	10	2200		1
90	80	200	58	100	398	51	65	46	8 x 19	F 07	10	3000		1
110	100	220	66	110	438	60	85	68	8 x 19	F 07	10	6500		1
125	110	250	73	125	447	69	111	92	8 x 23	F 07	10	11500		1
140	125	250	73	125	447	75	111	92	8 x 23	F 07	10	11500		1
160	150	285	76	142	459	86	138	122	8 x 24	F 07	10	16600		1
200	175	340	87	170	509	106	192	179	8 x 24	F 07	10	39600		1
225	200	340	87	170	509	120	192	179	8 x 24	F 07	10	39600		1
250	250	395	123	198	625	131	223	209	8 x 24	F 10	10	55200		1
280	250	395	119	198	629	146	223	209	12 x 24	F 10	10	55200		1
315	300	445	121	228	802	164	256	253	12 x 24	F 10	10	80000		1
355	350	505	140	255	372	185	325	305	16 x 24	F 12	6	90000		1
400	400	565	169	285	402	206	353	350	16 x 26	F 12	6	115000		1

Opsiyonlar: Akülü açma/kapama emniyet kumandalı olabilir. Oransal kontrol ünitesi, potansiyonetre, lokal kontrol ünitesi, pozisyon transmiyeri opsiyonları mevcuttur.

Boru flanş bağlantı ölçüleri: EN 1092 PN10, ISO 7005 PN10, ANSI B 16,5 class 150, BS 1560 1958

Aktüatör flanş bağlantı ölçüleri: ISO 5211/24V DC - 24V AC.

Options: Battery powered on/off can be safety controlled. Option control unit, potentiometer, local control unit, position transmitter options are available.

Pipe flange connection dimensions: EN 1092 PN10, ISO 7005 PN10, ANSI B 16,5 class 150, BS 1560 1958

Actuator flange connection measures: ISO 5211/24V DC - 24V AC.

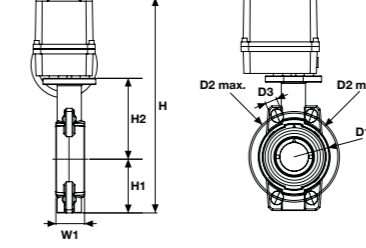
U-PVC Elektrik Aktüatörlü Kelebek Vana 100-260 V AC (Çıplak)
 U-PVC Butterfly Valves Electric Actuator 100 -260 V AC (With Out Flange)

Çap Dia	Basınç PN	Su için / For Water		Asit için / For Acid		Kg /Adet Kg/Pcs	Koli/Ad. Box/Pcs
		EPDM Conta Kod EPDM O-Ring Code	Fiyat (Adet) Price (Pcs)	FPM Conta Kod FPM O-Ring Code	Fiyat (Adet) Price (Pcs)		
63	10	303 00 063 1		303 10 063 1			1
75	10	303 00 075 1		303 10 075 1			1
90	10	303 00 090 1		303 10 090 1			1
110	10	303 00 110 1		303 10 110 1			1
125	10	303 00 125 1		303 10 125 1			1
140	10	303 00 140 1		303 10 140 1			1
160	10	303 00 160 1		303 10 160 1			1
200	10	303 00 200 1		303 10 200 1			1
225	10	303 00 225 1		303 10 225 1			1
250	10	303 00 250 1		303 10 250 1			1
280	10	303 00 280 1		303 10 280 1			1
315	10	303 00 315 1		303 10 315 1			1
355	6	303 00 355 1		303 10 355 1			1
400	6	303 00 400 1		303 10 400 1			1

Çap Dia	DN (mm)	D (mm)	Z (mm)	Z1 (mm)	Z2 (mm)	B (mm)	nØe	ISO 5211 ISO 5211
63	50	165	51	83	395	38	4 x 19	F 07
75	65	185	52	93	399	43	4 x 19	F 07
90	80	200	58	100	398	51	8 x 19	F 07
110	100	220	66	110	438	60	8 x 19	F 07
125	110	250	73	125	447	69	8 x 23	F 07
140	125	250	73	125	447	75	8 x 23	F 07
160	150	285	76	143	459	86	8 x 24	F 07
200	175	340	87	170	509	106	8 x 24	F 07
225	200	340	87	170	509	120	8 x 24	F 07
250	250	395	123	198	625	131	8 x 24	F 10
280	250	395	119	198	629	146	12 x 24	F 10
315	300	445	121	228	802	164	12 x 24	F 10
355	350	505	140	255	372	185	16 x 24	F 12
400	400	565	169	285	402	206	16 x 26	F 12

Opsiyonlar: Akülü açma/kapama emniyet kumandalı olabilir. Oransal kontrol ünitesi, potansiyonetre, lokal kontrol ünitesi, pozisyon transmiyeri opsiyonları mevcuttur.

Boru flanş bağlantı ölçüleri: EN 1092 PN10, ISO 7005 PN10, ANSI B 16,5 class 150, BS 1560 1958

Aktüatör flanş bağlantı ölçüleri: ISO 5211/24V DC - 24V AC.

Options: Battery powered on/off can be safety controlled. Option control unit, potentiometer, local control unit, position transmitter options are available.

Pipe flange connection dimensions: EN 1092 PN10, ISO 7005 PN10, ANSI B 16,5 class 150, BS 1560 1958

Actuator flange connection measures: ISO 5211/24V DC - 24V AC.

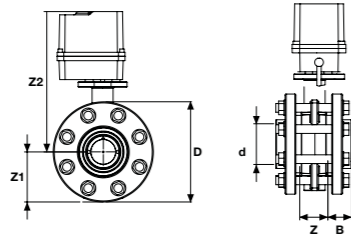
U-PVC Elektrik Aktüatörlü Kelebek Vana 100-260 V AC (Takım)
 U-PVC Butterfly Valves Electric Actuator 100 -260 V AC (With Flange)

Su İçin / For Water
Asit İçin / For Acid

Çap Dia	Basınç PN	EPDM Conta Kod EPDM O-Ring Code	Fiyat (Adet) Price (Pcs)	FPM Conta Kod FPM O-Ring Code	Fiyat (Adet) Price (Pcs)	Kg /Adet Kg/Pcs	Koli/Ad. Box/Pcs
63	10	305 00 063 4		305 01 063 4		3,10	1
75	10	305 00 075 4		305 01 075 4		3,33	1
90	10	305 00 090 4		305 01 090 4		3,83	1
110	10	305 00 110 4		305 01 110 4		4,32	1
125	10	305 00 125 4		305 01 125 4		6,60	1
140	10	305 00 140 4		305 01 140 4		8,95	1
160	10	305 00 160 4		305 01 160 4		9,18	1
200	10	305 00 200 4		305 01 200 4		12,2	1
225	10	305 00 225 4		305 01 225 4		14,9	1
250	10	305 00 250 4		305 01 250 4		28,5	1
280	10	305 00 280 4		305 01 280 4		28,5	1
315	10	305 00 315 4		305 01 315 4		36,1	1
355	6	305 00 355 4		305 01 355 4			1
400	6	305 00 400 4		305 01 400 4			1

Çap Dia	DN (mm)	D (mm)	Z (mm)	Z1 (mm)	Z2 (mm)	B (mm)	nØe	ISO 5211 ISO 5211
63	50	165	51	83	395	38	4 x 19	F 07
75	65	185	52	93	399	43	4 x 19	F 07
90	80	200	58	100	398	51	8 x 19	F 07
110	100	220	66	110	438	60	8 x 19	F 07
125	110	250	73	125	447	69	8 x 23	F 07
140	125	250	73	125	447	75	8 x 23	F 07
160	150	285	76	143	459	86	8 x 24	F 07
200	175	340	87	170	509	106	8 x 24	F 07
225	200	340	87	170	509	120	8 x 24	F 07
250	250	395	123	198	625	131	8 x 24	F 10
280	250	395	119	198	629	146	12 x 24	F 10
315	300	445	121	228	802	164	12 x 24	F 10
355	350	505	140	255	372	185	16 x 24	F 12
400	400	565	169	285	402	206	16 x 26	F 12

Opsiyonlar: Akülü açma/kapama emniyet kumandalı olabilir. Oransal kontrol ünitesi, potansiyometre, lokal kontrol ünitesi, pozisyon transmiyeri opsiyonları mevcuttur.

Boru flanş bağlantı ölçüleri: EN 1092 PN10, ISO 7005 PN10, ANSI B 16,5 class 150, BS 1560 1958

Aktüatör flanş bağlantı ölçüleri: ISO 5211/24V DC - 24V AC.

Options: Battery powered on/off can be safety controlled. Option control unit, potentiometer, local control unit, position transmitter options are available.

Pipe flange connection dimensions: EN 1092 PN10, ISO 7005 PN10, ANSI B 16,5 class 150, BS 1560 1958

Actuator flange connection measures: ISO 5211/24V DC - 24V AC.

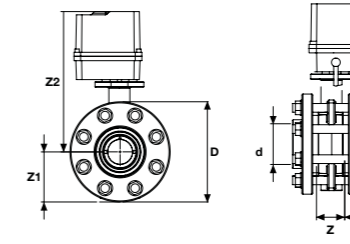
U-PVC Elektrik Aktüatörlü Kelebek Vana 100-260 V AC 304/316 Paslanmaz Civata-Somun-Pul
 U-PVC Butterfly Valves Electric Actuator 100 -260 V AC 304/316 Stainless Steel Screw-Nut-Washer (With Flange)

304 Paslanmaz Civata-Somun-Pul / 304.S.S.Screw,Nut,Washer
Su İçin / For Water
Asit İçin / For Acid

Çap Dia	EPDM Conta Kod EPDM O-Ring Code	Fiyat (Adet) Price (Pcs)	FPM Conta Kod FPM O-Ring Code	Fiyat (Adet) Price (Pcs)
63	307 00 063 4		307 01 063 4	
75	307 00 075 4		307 01 075 4	
90	307 00 090 4		307 01 090 4	
110	307 00 110 4		307 01 110 4	
125	307 00 125 4		307 01 125 4	
140	307 00 140 4		307 01 140 4	
160	307 00 160 4		307 01 160 4	
200	307 00 200 4		307 01 200 4	
225	307 00 225 4		307 01 225 4	
250	307 00 250 4		307 01 250 4	
280	307 00 280 4		307 01 280 4	
315	307 00 315 4		307 01 315 4	
355	307 00 355 4		307 01 355 4	
400	307 00 400 4		307 01 400 4	

316 Paslanmaz Civata-Somun-Pul / 316.S.S.Screw,Nut,Washer
Su İçin / For Water
Asit İçin / For Acid

Çap Dia	EPDM Conta Kod EPDM O-Ring Code	Fiyat (Adet) Price (Pcs)	FPM Conta Kod FPM O-Ring Code	Fiyat (Adet) Price (Pcs)
63	309 00 063 4		309 01 063 4	
75	309 00 075 4		309 01 075 4	
90	309 00 090 4		309 01 090 4	
110	309 00 110 4		309 01 110 4	
125	309 00 125 4		309 01 125 4	
140	309 00 140 4		309 01 140 4	
160	309 00 160 4		309 01 160 4	
200	309 00 200 4		309 01 200 4	
225	309 00 225 4		309 01 225 4	
250	309 00 250 4		309 01 250 4	
280	309 00 280 4		309 01 280 4	
315	309 00 315 4		309 01 315 4	
355	309 00 355 4		309 01 355 4	
400	309 00 400 4		309 01 400 4	

Çap Dia	DN (mm)	D (mm)	Z (mm)	Z1 (mm)	Z2 (mm)	B (mm)	Q1 (mm)	Q2 (mm)	nØe	ISO 5211 ISO 5211	Basınç PN	kv-value l/min.	Kg /Adet Kg/Pcs	Koli/Ad. Box/Pcs
63	50	165	51	82	395	38	37		4 x 19	F 07	10	1470	4,98	1
75	65	185	52	92	399	43	50	40	4 x 19	F 07	10	2200	5,58	1
90	80	200	58	100	398	51	65	46	8 x 19	F 07	10	3000	7,54	1
110	100	220	66	110	438	60	85	68	8 x 19	F 07	10	6500	9,65	1
125	110	250	73	125	447	69	111	92	8 x 23	F 07	10	11500	11,88	1
140	125	250	73	125	447	75	111	92	8 x 23	F 07	10	11500	14,63	1
160	150	285	76	142	459	86	138	122	8 x 24	F 07	10	16600	15,79	1
200	175	340	87	170	509	106	192	179	8 x 24	F 07	10	39600	24,69	1
225	200	340	87	170	509	120	192	179	8 x 24	F 07	10	39600	24,39	1
250	250	395	123	198	625	131	223	209	8 x 24	F 10	10	55200	45,56	1
280	250	395	119	198	629	146	223	209	12 x 24	F 10	10	55200	48,06	1
315	300	445	121	228	802	164	256	253	12 x 24	F 10	10	80000	56,32	1
355	350	505	140	255	372	185	325	305	16 x 24	F 12	6	90000		1
400	400	565	169	285	402	206	353	350	16 x 26	F 12	6	115000		1

Opsiyonlar: Akülü açma/kapama emniyet kumandalı olabilir. Oransal kontrol ünitesi, potansiyometre, lokal kontrol ünitesi, pozisyon transmiyeri opsiyonları mevcuttur.

Boru flanş bağlantı ölçüleri: EN 1092 PN10, ISO 7005 PN10, ANSI B 16,5 class 150, BS 1560 1958

Aktüatör flanş bağlantı ölçüleri: ISO 5211/24V DC - 24V AC.

Options: Battery powered on/off can be safety controlled. Option control unit, potentiometer, local control unit, position transmitter options are available.

Pipe flange connection dimensions: EN 1092 PN10, ISO 7005 PN10, ANSI B 16,5 class 150, BS 1560 1958

Actuator flange connection measures: ISO 5211/24V DC - 24V AC.

U-PVC Pnömatik Aktüatörlü Kelebek Vana Çift Etkili (Çıplak)

U-PVC Pneumatic Actuator Butterfly Valves Double Effect Without Flange

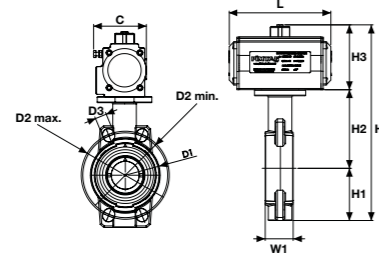

Su İçin / For Water

Asit İçin / For Acid

Çap Dia	Basınç PN	EPDM Conta Kod EPDM O-Ring Code	Fiyat (Adet) Price (Pcs)	FPM Conta Kod FPM O-Ring Code	Fiyat (Adet) Price (Pcs)	Kg /Adet Kg/Pcs	Koli/Ad. Box/Pcs
63	10	318 00 063 4		318 01 063 4		2,25	1
75	10	318 00 075 4		318 01 075 4		2,48	1
90	10	318 00 090 4		318 01 090 4		3,71	1
110	10	318 00 110 4		318 01 110 4		4,20	1
125	10	318 00 125 4		318 01 125 4		7,15	1
140	10	318 00 140 4		318 01 140 4		8,00	1
160	10	318 00 160 4		318 01 160 4		9,98	1
200	10	318 00 200 4		318 01 200 4		13,7	1
225	10	318 00 225 4		318 01 225 4		13,7	1
250	10	318 00 250 4		318 01 250 4		30,5	1
280	10	318 00 280 4		318 01 280 4		30,5	1
315	10	318 00 315 4		318 01 315 4		38,1	1
355	6	318 00 355 4		318 01 355 4			1
400	6	318 00 400 4		318 01 400 4			1

Çap Dia	DN (mm)	D1 (mm)	D2 min. (mm)	D2 max. (mm)	D3 (mm)	H (mm)	H1 (mm)	H2 (mm)	H3 (mm)	C (mm)	W1 (mm)	L (mm)	kv-value l/min.	ISO 5211 ISO 5211
63	50	54	120	125	19	303	77	134	92	72	45	147	1470	F 07
75	65	57	140	145	19	307	86	129	92	72	46	147	2200	F 07
90	80	131	150	160	19	307	89	132	108	83	48	168	3000	F 07
110	100	160	175	190	19	379	103	156	120	95	56	184	6500	F 07
125	110	190	210	216	23	405	116	169	120	95	63	184	11500	F 07
140	125	190	210	216	23	405	116	169	120	100	63	184	11500	F 07
160	150	214	241	241	24	441	129	182	130	100	66	204	16600	F 07
200	175	268	290	295	24	501	158	203	140	108	75	262	39600	F 07
225	200	268	290	295	24	501	158	203	140	108	75	262	39600	F 07
250	250	333	341	362	24	593	198	242	153	122	114	268	55200	F 10
280	250	333	341	362	24	593	198	242	153	122	114	268	55200	F 10
315	300	379	400	432	25	668	228	285	175	142	113	296	80000	F 10
355	350	345	460	-	25	670	345	410	260	226	88	525	90000	F 12
400													115000	F 12

Opsiyonlar: Kolay montaj/demontaj imkanı, pozisyoner, limit anahtar kutusu, namur solenoid vana, el kontrol ünitesi.

Aktüatör flanş bağlantı ölçüleri: ISO 5211.

İhtiyaca göre opsiyon ilave edilebilir.

Options: Easy assembly/disassembly, potentiometer, limit switch box, namur solenoid valve, hand control unit.

Actuator flange connection dimensions: ISO 5211

Options could be add according to the needs.

U-PVC Pnömatik Aktüatörlü Kelebek Vana Çift Etkili (Takım)

U-PVC Pneumatic Actuator Butterfly Valves Double Effect With Flange

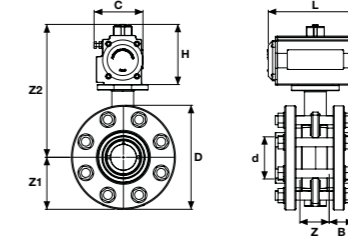

Su İçin / For Water

Asit İçin / For Acid

Çap Dia	Basınç PN	EPDM Conta Kod EPDM O-Ring Code	Fiyat (Adet) Price (Pcs)	FPM Conta Kod FPM O-Ring Code	Fiyat (Adet) Price (Pcs)	Kg /Adet Kg/Pcs	Koli/Ad. Box/Pcs
63	10	319 00 063 4		319 01 063 4		4,13	1
75	10	319 00 075 4		319 01 075 4		4,73	1
90	10	319 00 090 4		319 01 090 4		7,42	1
110	10	319 00 110 4		319 01 110 4		9,53	1
125	10	319 00 125 4		319 01 125 4		12,43	1
140	10	319 00 140 4		319 01 140 4		13,68	1
160	10	319 00 160 4		319 01 160 4		16,59	1
200	10	319 00 200 4		319 01 200 4		23,19	1
225	10	319 00 225 4		319 01 225 4		23,19	1
250	10	319 00 250 4		319 01 250 4		47,56	1
280	10	319 00 280 4		319 01 280 4		50,06	1
315	10	319 00 315 4		319 01 315 4		58,32	1
355	6	319 00 355 4		319 01 355 4			1
400	6	319 00 400 4		319 01 400 4			1

Çap Dia	DN (mm)	C (mm)	D (mm)	Z (mm)	Z1 (mm)	B (mm)	L (mm)	H (mm)	nØe (mm)	kv-value l/min.	ISO 5211 ISO 5211
63	50	72	165	51	82	38	147	90	4 x 19	1470	F 07
75	65	72	185	52	92	43	147	90	4 x 19	2200	F 07
90	80	63	200	58	100	51	168	108	8 x 19	3000	F 07
110	100	95	220	66	110	60	184	120	8 x 19	6500	F 07
125	110	95	250	73	125	69	184	120	8 x 23	11500	F 07
140	125	100	250	73	125	75	184	120	8 x 23	11500	F 07
160	150	100	285	76	142	86	204	130	8 x 24	16600	F 07
200	175	108	340	87	170	106	262	140	8 x 24	39600	F 07
225	200	108	340	87	170	120	262	140	8 x 24	39600	F 07
250	250	122	395	123	198	131	268	153	8 x 24	55200	F 10
280	250	122	395	119	198	146	268	153	12 x 24	55200	F 10
315	300	142	445	121	228	164	296	175	12 x 24	80000	F 10
355										90000	
400										115000	

Opsiyonlar: Kolay montaj/demontaj imkanı, pozisyoner, limit anahtar kutusu, namur solenoid vana, el kontrol ünitesi.

Aktüatör flanş bağlantı ölçüleri: ISO 5211.

İhtiyaca göre opsiyon ilave edilebilir.

Options: Easy assembly/disassembly, potentiometer, limit switch box, namur solenoid valve, hand control unit.

Actuator flange connection dimensions: ISO 5211

Options could be add according to the needs.

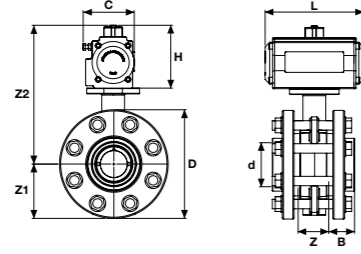
U-PVC Pnömatik Aktüatörlü Kelebek Vana Çift Etkili 304/316 Paslanmaz Civata-Somun-Pul
 U-PVC Pneumatic Actuator Butterfly Valves Double Effect 304/316 S.S. Screw, Nut, Washer

304 Paslanmaz Civata-Somun-Pul / 304.S.S.Screw,Nut,Washer

Çap Dia	Su İçin / For Water		Asit İçin / For Acid	
	EPDM Conta Kod EPDM O-Ring Code	Fiyat (Adet) Price (Pcs)	FPM Conta Kod FPM O-Ring Code	Fiyat (Adet) Price (Pcs)
63	320 00 063 4		320 01 063 4	
75	320 00 075 4		320 01 075 4	
90	320 00 090 4		320 01 090 4	
110	320 00 110 4		320 01 110 4	
125	320 00 125 4		320 01 125 4	
140	320 00 140 4		320 01 140 4	
160	320 00 160 4		320 01 160 4	
200	320 00 200 4		320 01 200 4	
225	320 00 225 4		320 01 225 4	
250	320 00 250 4		320 01 250 4	
280	320 00 280 4		320 01 280 4	
315	320 00 315 4		320 01 315 4	
355	320 00 355 4		320 01 355 4	
400	320 00 400 4		320 01 400 4	

316 Paslanmaz Civata-Somun-Pul / 316.S.S.Screw,Nut,Washer

Çap Dia	Su İçin / For Water		Asit İçin / For Acid	
	EPDM Conta Kod EPDM O-Ring Code	Fiyat (Adet) Price (Pcs)	FPM Conta Kod FPM O-Ring Code	Fiyat (Adet) Price (Pcs)
63	321 00 063 4		321 01 063 4	
75	321 00 075 4		321 01 075 4	
90	321 00 090 4		321 01 090 4	
110	321 00 110 4		321 01 110 4	
125	321 00 125 4		321 01 125 4	
140	321 00 140 4		321 01 140 4	
160	321 00 160 4		321 01 160 4	
200	321 00 200 4		321 01 200 4	
225	321 00 225 4		321 01 225 4	
250	321 00 250 4		321 01 250 4	
280	321 00 280 4		321 01 280 4	
315	321 00 315 4		321 01 315 4	
355	321 00 355 4		321 01 355 4	
400	321 00 400 4		321 01 400 4	

Çap Dia	DN (mm)	C (mm)	D (mm)	Z (mm)	Z1 (mm)	B (mm)	L (mm)	H (mm)	Q1 (mm)	Q2 (mm)	nØe (mm)	ISO 5211 ISO 5211	Basınç PN	kv-value l/min.	Kg /Adet Kg/Pcs	Koli/Ad. Box/Pcs
63	50	72	165	51	82	38	147	90	37		4 x 19	F 07	10	1470	4,13	1
75	65	72	185	52	92	43	147	90	50	40	4 x 19	F 07	10	2200	4,73	1
90	80	63	200	58	100	51	168	108	65	46	8 x 19	F 07	10	3000	7,42	1
110	100	95	220	66	110	60	184	120	85	68	8 x 19	F 07	10	6500	9,53	1
125	110	95	250	73	125	69	184	120	111	92	8 x 23	F 07	10	11500	12,43	1
140	125	100	250	73	125	75	184	120	111	92	8 x 23	F 07	10	11500	13,68	1
160	150	100	285	76	142	86	204	130	138	122	8 x 24	F 07	10	16600	16,59	1
200	175	108	340	87	170	106	262	140	192	179	8 x 24	F 07	10	39600	23,19	1
225	200	108	340	87	170	120	262	140	192	179	8 x 24	F 07	10	39600	23,19	1
250	250	122	395	123	198	131	268	153	223	209	8 x 24	F 10	10	55200	47,56	1
280	250	122	395	119	198	146	268	153	223	209	12 x 24	F 10	10	55200	50,06	1
315	300	142	445	121	228	164	296	175	256	253	12 x 24	F 10	10	80000	58,32	1
355									325	305			6	90000		1
400									353	350			6	115000		1

Opsiyonlar: Kolay montaj/demontaj imkanı, pozisyoner, limit anahtar kutusu, namur solenoid vana, el kontrol ünitesi.
Aktüatör flanş bağlantı ölçüleri: ISO 5211.
 İhtiyaca göre opsiyon ilave edilebilir.

Options: Easy assembly/disassembly, potentiometer, limit switch box, namur selenoid valve, hand control unit.
Actuator flange connection dimensions: ISO 5211
 Options could be add according to the needs.

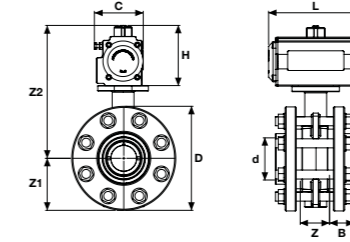
U-PVC Pnömatik Aktüatörlü Kelebek Vana Tek Etkili Takım
 U-PVC Pneumatic Actuator Butterfly Valves Single Effect Without Flange

Çap Dia	Basınç PN	Su İçin / For Water		Asit İçin / For Acid		Kg /Adet Kg/Pcs	Koli/Ad. Box/Pcs
		EPDM Conta Kod EPDM O-Ring Code	Fiyat (Adet) Price (Pcs)	FPM Conta Kod FPM O-Ring Code	Fiyat (Adet) Price (Pcs)		
63	10	312 00 063 4		312 01 063 4		4,13	1
75	10	312 00 075 4		312 01 075 4		4,73	1
90	10	312 00 090 4		312 01 090 4		7,42	1
110	10	312 00 110 4		312 01 110 4		9,53	1
125	10	312 00 125 4		312 01 125 4		12,43	1
140	10	312 00 140 4		312 01 140 4		13,68	1
160	10	312 00 160 4		312 01 160 4		16,59	1
200	10	312 00 200 4		312 01 200 4		23,19	1
225	10	312 00 225 4		312 01 225 4		23,19	1
250	10	312 00 250 4		312 01 250 4		47,56	1
280	10	312 00 280 4		312 01 280 4		50,06	1
315	10	312 00 315 4		312 01 315 4		58,32	1
355	6	312 00 355 4		312 01 355 4			1
400	6	312 00 400 4		312 01 400 4			1

Çap Dia	DN (mm)	C (mm)	D (mm)	Z (mm)	Z1 (mm)	B (mm)	L (mm)	H (mm)	nØe (mm)	kv-value l/min.	ISO 5211 ISO 5211
63	50	72	165	51	82	38	147	90	4 x 19	1470	F 07
75	65	72	185	52	92	43	147	90	4 x 19	2200	F 07
90	80	63	200	58	100	51	168	108	8 x 19	3000	F 07
110	100	95	220	66	110	60	184	120	8 x 19	6500	F 07
125	110	95	250	73	125	69	184	120	8 x 23	11500	F 07
140	125	100	250	73	125	75	184	120	8 x 23	11500	F 07
160	150	100	285	76	142	86	204	130	8 x 24	16600	F 07
200	175	108	340	87	170	106	262	140	8 x 24	39600	F 07
225	200	108	340	87	170	120	262	140	8 x 24	39600	F 07
250	250	122	395	123	198	131	268	153	8 x 24	55200	F 10
280	250	122	395	119	198	146	268	153	12 x 24	55200	F 10
315	300	142	445	121	228	164	296	175	12 x 24	80000	F 10
355										90000	
400										115000	

Opsiyonlar: Kolay montaj/demontaj imkanı, pozisyoner, limit anahtar kutusu, namur solenoid vana, el kontrol ünitesi.
Aktüatör flanş bağlantı ölçüleri: ISO 5211.
 İhtiyaca göre opsiyon ilave edilebilir.

Options: Easy assembly/disassembly, potentiometer, limit switch box, namur selenoid valve, hand control unit.
Actuator flange connection dimensions: ISO 5211
 Options could be add according to the needs.

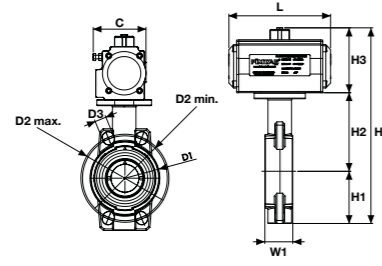
U-PVC Pnömatik Aktüatörlü Kelebek Vana Tek Etkili Çıplak
 U-PVC Pneumatic Actuator Butterfly Valves Single Effect Without Flange

Su İçin / For Water
Asit İçin / For Acid

Çap Dia	Basınç PN	EPDM Conta Kod EPDM O-Ring Code	Fiyat (Adet) Price (Pcs)	FPM Conta Kod FPM O-Ring Code	Fiyat (Adet) Price (Pcs)	Kg /Adet Kg/Pcs	Koli/Ad. Box/Pcs
63	10	310 00 063 4		310 01 063 4		2,25	1
75	10	310 00 075 4		310 01 075 4		2,48	1
90	10	310 00 090 4		310 01 090 4		3,71	1
110	10	310 00 110 4		310 01 110 4		4,20	1
125	10	310 00 125 4		310 01 125 4		7,15	1
140	10	310 00 140 4		310 01 140 4		8,00	1
160	10	310 00 160 4		310 01 160 4		9,98	1
200	10	310 00 200 4		310 01 200 4		13,7	1
225	10	310 00 225 4		310 01 225 4		13,7	1
250	10	310 00 250 4		310 01 250 4		30,5	1
280	10	310 00 280 4		310 01 280 4		30,5	1
315	10	310 00 315 4		310 01 315 4		38,1	1
355	6	310 00 355 4		310 01 355 4			1
400	6	310 00 400 4		310 01 400 4			1

Çap Dia	DN (mm)	D1 (mm)	D2 min. (mm)	D2 max. (mm)	D3 (mm)	H (mm)	H1 (mm)	H2 (mm)	H3 (mm)	C (mm)	W1 (mm)	L (mm)	kv-value l/min.	ISO 5211 ISO 5211
63	50	54	120	125	19	303	77	134	92	72	45	147	1470	F 07
75	65	57	140	145	19	307	86	129	92	72	46	147	2200	F 07
90	80	131	150	160	19	307	89	132	108	83	48	168	3000	F 07
110	100	160	175	190	19	379	103	156	120	95	56	184	6500	F 07
125	110	190	210	216	23	405	116	169	120	95	63	184	11500	F 07
140	125	190	210	216	23	405	116	169	120	100	63	184	11500	F 07
160	150	214	241	241	24	441	129	182	130	100	66	204	16600	F 07
200	175	268	290	295	24	501	158	203	140	108	75	262	39600	F 07
225	200	268	290	295	24	501	158	203	140	108	75	262	39600	F 07
250	250	333	341	362	24	593	198	242	153	122	114	268	55200	F 10
280	250	333	341	362	24	593	198	242	153	122	114	268	55200	F 10
315	300	379	400	432	25	668	228	285	175	142	113	296	80000	F 10
355													90000	
400													115000	

Opsiyonlar: Kolay montaj/demontaj imkanı, pozisyoner, limit anahtar kutusu, namur solenoid vana, el kontrol ünitesi.
Aktüatör flanş bağlantı ölçüleri: ISO 5211.
 İhtiyaca göre opsiyon ilave edilebilir.

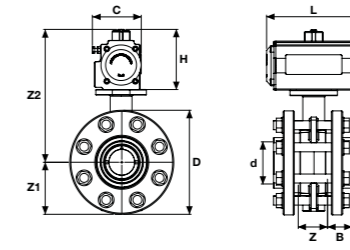
Options: Easy assembly/disassembly, potentiometer, limit switch box, namur solenoid valve, hand control unit.
Actuator flange connection dimensions: ISO 5211
 Options could be add according to the needs.

U-PVC Pnömatik Aktüatörlü Kelebek Vana Tek Etkili 304/316 Paslanmaz Civata-Somun-Pul
 U-PVC Pneumatic Actuator Butterfly Valves Double Effect 304/316 S.S. Screw, Nut,Washer

304 Paslanmaz Civata-Somun-Pul / 304.S.S.Screw,Nut,Washer
316 Paslanmaz Civata-Somun-Pul / 316.S.S.Screw,Nut,Washer
Su İçin / For Water
Asit İçin / For Acid
Su İçin / For Water
Asit İçin / For Acid

Çap Dia	EPDM Conta Kod EPDM O-Ring Code	Fiyat (Adet) Price (Pcs)	FPM Conta Kod FPM O-Ring Code	Fiyat (Adet) Price (Pcs)	Çap Dia	EPDM Conta Kod EPDM O-Ring Code	Fiyat (Adet) Price (Pcs)	FPM Conta Kod FPM O-Ring Code	Fiyat (Adet) Price (Pcs)
63	314 00 063 4		314 01 063 4		63	316 00 063 4		316 01 063 4	
75	314 00 075 4		314 01 075 4		75	316 00 075 4		316 01 075 4	
90	314 00 090 4		314 01 090 4		90	316 00 090 4		316 01 090 4	
110	314 00 110 4		314 01 110 4		110	316 00 110 4		316 01 110 4	
125	314 00 125 4		314 01 125 4		125	316 00 125 4		316 01 125 4	
140	314 00 140 4		314 01 140 4		140	316 00 140 4		316 01 140 4	
160	314 00 160 4		314 01 160 4		160	316 00 160 4		316 01 160 4	
200	314 00 200 4		314 01 200 4		200	316 00 200 4		316 01 200 4	
225	314 00 225 4		314 01 225 4		225	316 00 225 4		316 01 225 4	
250	314 00 250 4		314 01 250 4		250	316 00 250 4		316 01 250 4	
280	314 00 280 4		314 01 280 4		280	316 00 280 4		316 01 280 4	
315	314 00 315 4		314 01 315 4		315	316 00 315 4		316 01 315 4	
355	314 00 355 4		314 01 355 4		355	316 00 355 4		316 01 355 4	
400	314 00 400 4		314 01 400 4		400	316 00 400 4		316 01 400 4	

Çap Dia	DN (mm)	C (mm)	D (mm)	Z (mm)	Z1 (mm)	B (mm)	L (mm)	H (mm)	nØe (mm)	ISO 5211 ISO 5211	Basınç PN	kv-value l/min.	Q1 (mm)	Q2 (mm)	Kg /Adet Kg/Pcs	Koli/Ad. Box/Pcs
63	50	72	165	51	82	38	147	90	4 x 19	F 07	10	1470	37		4,13	1
75	65	72	185	52	92	43	147	90	4 x 19	F 07	10	2200	50	40	4,73	1
90	80	63	200	58	100	51	168	108	8 x 19	F 07	10	3000	65	46	7,42	1
110	100	95	220	66	110	60	184	120	8 x 19	F 07	10	6500	85	68	9,53	1
125	110	95	250	73	125	69	184	120	8 x 23	F 07	10	11500	111	92	12,43	1
140	125	100	250	73	125	75	184	120	8 x 23	F 07	10	11500	111	92	13,68	1
160	150	100	285	76	142	86	204	130	8 x 24	F 07	10	16600	138	122	16,59	1
200	175	108	340	87	170	106	262	140	8 x 24	F 07	10	39600	192	179	23,19	1
225	200	108	340	87	170	120	262	140	8 x 24	F 07	10	39600	192	179	23,19	1
250	250	122	395	123	198	131	268	153	8 x 24	F 10	10	55200	223	209	47,56	1
280	250	122	395	119	198	146	268	153	12 x 24	F 10	10	55200	223	209	50,06	1
315	300	142	445	121	228	164	296	175	12 x 24	F 10	10	80000	256	253	58,32	1
355											6	90000	325	305		1
400											6	115000	353	350		1

Opsiyonlar: Kolay montaj/demontaj imkanı, pozisyoner, limit anahtar kutusu, namur solenoid vana, el kontrol ünitesi.
Aktüatör flanş bağlantı ölçüleri: ISO 5211.
 İhtiyaca göre opsiyon ilave edilebilir.

Options: Easy assembly/disassembly, potentiometer, limit switch box, namur solenoid valve, hand control unit.
Actuator flange connection dimensions: ISO 5211
 Options could be add according to the needs.

Limit Switch Kutusu
 Limit Switch Box

Kod Code	Fiyat (Adet) Price (Pcs)	Koli/Adet Box/Pcs
201 19 063 9		1

Gövde / Body : Alüminyum / Aluminium
 Koruma / Protection Class : IP67

Namur Valf (Yön Valf)
 Solenoid Valve

Model	Kod Code	Fiyat (Adet) Price (Pcs)	Koli/Adet Box/Pcs
220VAC 1/4" 5-2	201 18 063 9		1
24VDC 1/4" 5-2	201 18 163 9		1
12VDC-AC 1/4"5-2	201 18 263 9		1

Gövde / Body : Alüminyum / Aluminium
 Koruma / Protection Class : IP67
 Pozisyon / Positions : 3/2-5/2
 Model : Tek ve Çift Bobinli /Single Coil and Double Coils

Rotary Elektro Pnömatik Pozisyoner
 Rotary Elektro Pneumatic Positioner

Kod Code	Fiyat (Adet) Price (Pcs)	Koli/Adet Box/Pcs
201 21 063 9		1

Solenoid Valf (Normalde Kapalı)
 Solenoid Valf (Normally Close)

Ölçü Size	Basınç PN	Kod Code	Fiyat (Adet) Price (Pcs)	Model
1/8"	0-16 bar	T00000400		GEM 1110
1/4"	0-16 bar	T00000401		GEM 1111
3/8"	0.5-16 bar	T00000402		GEM 1112
1/2"	0.5-16 bar	T00000403		GEM 1113
3/4"	0.5-16 bar	T00000404		GEM 1114
1"	0.5-16 bar	T00000405		GEM 1115
1 1/4"	0.5-16 bar	T00000406		GEM 1116
1 1/2"	0.5-16 bar	T00000407		GEM 1117
2"	0.5-16 bar	T00000408		GEM 1118

Conta / Gasket : NBR
 Kovan / Shell : Paslanmaz / Rustproof
 Gövde / Body : Piriç
 Çekirdek / Core : Paslanmaz / Rustproof
 Sıcaklık / Heat : -10/+90°C
 Bobin / Coil : Soketli / Socket

Solenoid Valf (Normalde Açık)
 Solenoid Valf (Normally Open)

Ölçü Size	Basınç PN	Kod Code	Fiyat (Adet) Price (Pcs)	Model
3/8"	0.5-16 bar	T00000409		GEM 1112 A
1/2"	0.5-16 bar	T00000410		GEM 1113 A
3/4"	0.5-16 bar	T00000411		GEM 1114 A
1"	0.5-16 bar	T00000412		GEM 1115 A
1 1/4"	0.5-16 bar	T00000413		GEM 1116 A
1 1/2"	0.5-16 bar	T00000414		GEM 1117 A
2"	0.5-16 bar	T00000415		GEM 1118 A

Conta / Gasket : NBR
 Kovan / Shell : Piriç
 Gövde / Body : Piriç
 Çekirdek / Core : Paslanmaz / Rustproof
 Sıcaklık / Heat : -10/+90°C
 Bobin / Coil : Soketli / Socket



Not / Note

U-PVC

KÜRESEL VANA

BALL VALVE

ÜRETİM STANDARDI
PRODUCTION STANDARD

TS EN ISO 16135

ÇAP / SIZE Ø20 - Ø110



 **PIMTAŞ®**

Since 1977

U-PVC Yapıştırma Muflu Küresel Su Vanası

U-PVC Solvent Cement True Union Ball Valve For Water

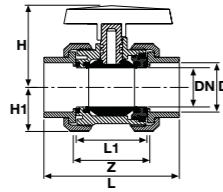

Çap Dia	Basınç PN	EPDM Conta Kod EPDM O-Ring Code	Fiyat (Adet) Price (Pcs)	Kg/Adet Kg/Pcs	Koli/Adet Box/Pcs	DN (mm)	kv l/min	Z mm	L1 (mm)	L (mm)	H (mm)	H1 (mm)
16	16	202 00 016 2		1	55	12	70	50	42	80	47	27
20	16	202 00 020 2		0,14	55	15	185	52	45	85	47	27
25	16	202 00 025 2		0,18	75	20	350	58	49	95	51	31
32	16	202 00 032 2		0,25	60	25	700	61	54	107	63	33
40	16	202 00 040 2		0,43	30	32	1000	73	66	128	67	41
50	16	202 00 050 2		0,65	20	40	1600	82	75	154	86	46
63	16	202 00 063 2		1,13	12	50	3100	95	89	172	101	58
75	16	202 00 075 2		1,47	5	65	5000	118	111	196	110	73
90	16	202 00 090 2		3,58	4	80	7000	139	126	241	137	89
110	16	202 00 110 2		5,43	2	100	11000	165	153	289	150	105

U-PVC Küresel Su Vanası Tek Taraf İçten Dışlı

U-PVC One Side Female Threaded True Union Ball Valve For Water

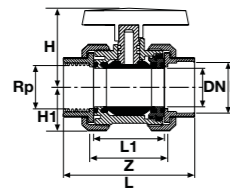

Çap Dia	Rp (Inch)	Basınç PN	EPDM Conta Kod EPDM O-Ring Code	Fiyat (Adet) Price (Pcs)	Kg/Adet Kg/Pcs	Koli/Adet Box/Pcs	DN (mm)	kv l/min	Z mm	L1 (mm)	L (mm)	H (mm)	H1 (mm)
16	3/8"	16	203 00 016 2		0	55	12	70	50	42	80	47	27
20	1/2"	16	203 00 020 2		0,14	55	15	185	52	45	85	47	27
25	3/4"	16	203 00 025 2		0,19	75	20	350	58	49	95	51	31
32	1"	16	203 00 032 2		0,24	60	25	700	61	54	107	63	33
40	1 1/4"	16	203 00 040 2		0,42	30	32	1000	73	66	128	67	41
50	1 1/2"	16	203 00 050 2		0,66	20	40	1600	82	75	154	86	46
63	2"	16	203 00 063 2		1,17	12	50	3100	95	89	172	101	58
75	2 1/2"	16	203 00 075 2		1,48	9	65	5000	118	111	196	110	73
90	3"	16	203 00 090 2		3,56	4	80	7000	139	126	241	137	89
110	4"	16	203 00 110 2		5,35	2	100	11000	165	153	289	150	105

U-PVC Küresel Su Vanası Çift Taraf İçten Dışlı

U-PVC Both Sides Female Threaded True Union Ball Valve For Water

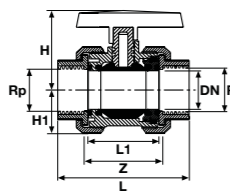

Çap Dia	Rp (Inch)	Basınç PN	EPDM Conta Kod EPDM O-Ring Code	Fiyat (Adet) Price (Pcs)	Kg/Adet Kg/Pcs	Koli/Adet Box/Pcs	DN (mm)	kv l/min	Z mm	L1 (mm)	L (mm)	H (mm)	H1 (mm)
16	3/8"	16	204 00 016 2		0,19	55	12	70	50	42	80	47	27
20	1/2"	16	204 00 020 2		0,14	55	15	185	52	45	85	47	27
25	3/4"	16	204 00 025 2		0,19	75	20	350	58	49	95	51	31
32	1"	16	204 00 032 2		0,24	60	25	700	61	54	107	63	33
40	1 1/4"	16	204 00 040 2		0,42	30	32	1000	73	66	128	67	41
50	1 1/2"	16	204 00 050 2		0,66	20	40	1600	82	75	154	86	46
63	2"	16	204 00 063 2		1,17	12	50	3100	95	89	172	101	58
75	2 1/2"	16	204 00 075 2		1,48	9	65	5000	118	111	196	110	73
90	3"	16	204 00 090 2		3,56	4	80	7000	139	126	241	137	89
110	4"	16	204 00 110 2		5,35	2	100	11000	165	153	289	150	105

U-PVC Küresel Su Vanası Çift Taraf Flanş Bağlantılı

U-PVC Both Sides Female Threaded Ball Valve For Water

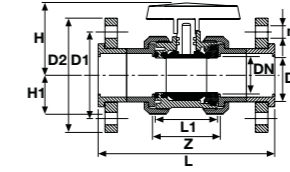

Çap Dia	Basınç PN	EPDM Conta Kod EPDM O-Ring Code	Fiyat (Adet) Price (Pcs)	Kg/Adet Kg/Pcs	Koli/Adet Box/Pcs	DN (mm)	kv l/min	Z mm	L1 (mm)	L (mm)	H (mm)	H1 (mm)	D1 (mm)	D2 (mm)	n (mmxAdet)
20	16	208 00 020 2		0,36	40	15	185	52	45	123	47	27	65	95	14 x 4
25	16	208 00 025 2		0,47	30	20	350	58	49	140	51	31	75	105	14 x 4
32	16	208 00 032 2		0,66	25	25	700	61	54	158	63	33	85	115	14 x 4
40	16	208 00 040 2		1,08	20	32	1000	73	66	186	67	42	100	140	18 x 4
50	16	208 00 050 2		1,44	10	40	1600	82	75	231	86	46	110	150	18 x 4
63	16	208 00 063 2		2,29	10	50	3100	95	89	253	101	58	125	165	18 x 4
75	16	208 00 075 2		2,99	4	65	5000	118	111	291	110	73	145	185	18 x 4
90	16	208 00 090 2		5,7	2	80	7000	139	126	353	137	90	160	200	18 x 8
110	16	208 00 110 2		8,05	1	100	11000	165	153	431	150	106	180	220	18 x 8

U-PVC Üç Yollu Küresel Vana (T Port)

U-PVC Three Ways Ball Valve (T Port)

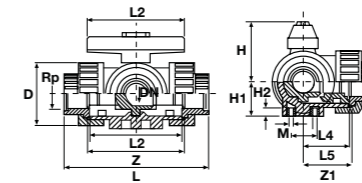

Çap Dia	Basınç PN	Kod Code	Fiyat (Adet) Price (Pcs)	Kg/Adet Kg/Pcs	Koli/Adet Box/Pcs	D (mm)	L (mm)	L1 (mm)	L2 (mm)	L3 (mm)	L4 (mm)	L5 (mm)	L6 (mm)	L7 (mm)	H (mm)
20	10	210 01 020 4		0,25	55	45	134	78	72	139	25	36	67	70	50
25	10	210 01 025 4		0,36	75	53	156	92	86	161	25	43	78	81	60
32	10	210 01 032 4		0,54	60	65	172	100	96	177	25	48	86	89	68
40	10	210 01 040 4		0,93	30	78	202	110	116	207	45	58	101	104	79
50	10	210 01 050 4		1,36	20	92	238	120	137	242	45	69	119	121	90
63	10	210 01 063 4		2,66	12	116	290	146	179	294	45	90	145	147	109

U-PVC Üç Yollu Üç Taraf İçten Dışlı Küresel Vana (T Port)

U-PVC Three Ways Female Threaded Ball Valve (T Port)

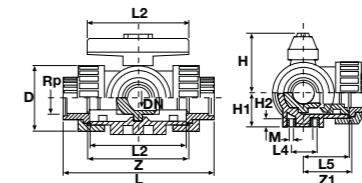

Çap Dia	Basınç PN	Kod Code	Fiyat (Adet) Price (Pcs)	Kg/Adet Kg/Pcs	Koli/Adet Box/Pcs	D (mm)	L (mm)	L1 (mm)	L2 (mm)	L4 (mm)	L5 (mm)	H (mm)	H1 (mm)
20	10	211 00 020 4		0,25	55	45	111	78	72	25	36	50	27
25	10	211 00 025 4		0,36	75	53	131	92	86	25	43	60	33
32	10	211 00 032 4		0,54	60	65	148	100	96	25	48	68	36
40	10	211 00 040 4		0,93	30	78	176	110	116	45	58	79	44
50	10	211 00 050 4		1,4	20	92	206	120	137	45	69	90	49
63	10	211 00 063 4		2,66	12	116	262	146	179	45	90	109	61

U-PVC Yapıştırma Muflu Küresel Su Vanası (Pozisyon Ayarlı)

U-PVC Solvent Cement True Union Ball Valve Position Regulated For Water

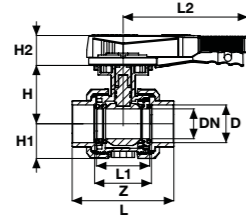

Çap Dia	Basınç PN	EPDM Conta Kod EPDM O-Ring Code	Fiyat (Adet) Price (Pcs)	Kg/Adet Kg/Pcs	Koli/Adet Box/Pcs	DN (mm)	Z (mm)	L1 (mm)	L2 (mm)	L (mm)	H (mm)	H1 (mm)	H2 (mm)	kv l/min
63	16	202 10 063 2		1,16	12	50	95	89	207,5	172	101	58	48	3100
75	16	202 10 075 2		1,45	9	65	118	111	207,5	196	110	73	50	5000
90	16	202 10 090 2		3,51	2	80	139	126	207,5	241	137	89	52	7000
110	16	202 10 110 2		5,40	2	100	165	153	259,5	289	150	105	52	11000

U-PVC Yapıştırma Muflu Küresel Su Vanası Tek Taraf İçten Dişli (Pozisyon Ayarlı)

U-PVC True Union Ball Valves Position Regulated For Water One Side Female Threaded

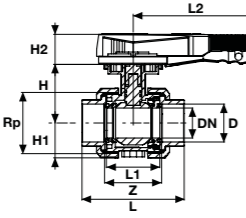

Çap Dia	Rp (Inch)	Basınç PN	EPDM Conta Kod EPDM O-Ring Code	Fiyat (Adet) Price (Pcs)	Kg/Adet Kg/Pcs	Koli/Adet Box/Pcs	DN (mm)	Z (mm)	L1 (mm)	L2 (mm)	L (mm)	H (mm)	H1 (mm)	H2 (mm)	kv l/min
63	2"	16	203 10 063 2		1,16	12	50	95	89	207,5	172	101	58	48	3100
75	2 1/2"	16	203 10 075 2		1,45	9	65	118	111	207,5	196	110	73	50	5000
90	3"	16	203 10 090 2		3,51	4	80	139	126	207,5	241	137	89	52	7000
110	4"	16	203 10 110 2		5,40	2	100	165	153	259,5	289	150	105	52	11000

U-PVC Küresel Su Vanası Çift Taraf İçten Dişli (Pozisyon Ayarlı)

U-PVC True Union Ball Valves Position Regulated For Water One Side Female Threaded

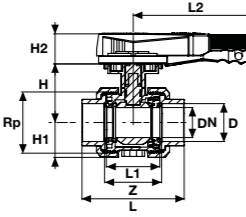

Çap Dia	Rp (Inch)	Basınç PN	EPDM Conta Kod EPDM O-Ring Code	Fiyat (Adet) Price (Pcs)	Kg/Adet Kg/Pcs	Koli/Adet Box/Pcs	DN (mm)	Z (mm)	L1 (mm)	L2 (mm)	L (mm)	H (mm)	H1 (mm)	H2 (mm)	kv l/min
63	2"	16	204 10 063 2		1,16	12	50	95	89	207,5	172	101	58	48	3100
75	2 1/2"	16	204 10 075 2		1,45	9	65	118	111	207,5	196	110	73	50	5000
90	3"	16	204 10 090 2		3,51	4	80	139	126	207,5	241	137	89	52	7000
110	4"	16	204 10 110 2		5,40	2	100	165	153	259,5	289	150	105	52	11000

U-PVC Küresel Su Vanası Çift Taraf Flanş Bağlantılı (Pozisyon Ayarlı)

U-PVC Solvent Cement Both Sides Flanged True Union Ball Valve Position Regulated For Water

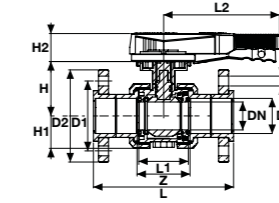

Çap Dia	Basınç PN	EPDM Conta Kod EPDM O-Ring Code	Fiyat (Adet) Price (Pcs)	Kg/Adet Kg/Pcs	Koli/Adet Box/Pcs	DN (mm)	Z (mm)	L1 (mm)	L2 (mm)	L (mm)	H (mm)	H1 (mm)	H2 (mm)	D1 (mm)	D2 (mm)	n (mm)	kv l/min
63	16	208 10 063 2		0,36	12	50	95	89	207,5	253	101	58	48	125	165	18x4	3100
75	16	208 10 075 2		0,47	9	65	118	111	207,5	291	110	64	50	145	185	22x4	5000
90	16	208 10 090 2		0,66	4	80	139	126	207,5	353	137	90	52	160	200	22x8	7000
110	16	208 10 110 2		1,08	2	100	165	153	259,5	431	150	106	52	180	220	24x8	11000



U-PVC Yapıştırma Muflu Küresel Su Vanası (Tek Tarafı Piriç İç Diş)

U-PVC One Side Brass Female Threaded Solvent Cement True Union Ball Valve For Water

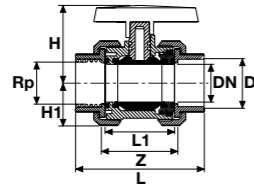

Çap Dia	Rp (Inch)	Basınç PN	Kod Code	Fiyat (Adet) Price (Pcs)	Kg/Adet Kg/Pcs	Koli/Adet Box/Pcs	DN (mm)	kv l/min	Z (mm)	L1 (mm)	L (mm)	H (mm)	H1 (mm)
20	1/2"	16	243 00 020 2		0,18	55	15	185	52	45	86	47	27
25	3/4"	16	243 00 025 2		0,24	75	20	350	58	49	96	51	31
32	1"	16	243 00 032 2		0,31	60	25	700	61	54	106	63	33
40	1 1/4"	16	243 00 040 2		0,50	30	32	1000	73	66	127	67	42
50	1 1/2"	16	243 00 050 2		0,80	20	40	1600	82	75	153	86	46
63	2"	16	243 00 063 2		1,36	12	50	3100	95	89	172	101	58

U-PVC İç Dişli Küresel Su Vanası (Tek Tarafı Piriç İç Diş)

U-PVC One Side Brass Female Threaded Other Side Female Threaded True Union Ball Valve For Water

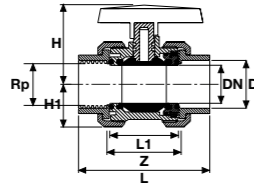

Çap Dia	Rp (Inch)	Basınç PN	Kod Code	Fiyat (Adet) Price (Pcs)	Kg/Adet Kg/Pcs	Koli/Adet Box/Pcs	DN (mm)	kv l/min	Z (mm)	L1 (mm)	L (mm)	H (mm)	H1 (mm)
20	1/2"	16	244 00 020 2		0,20	55	15	185	52	45	86	47	27
25	3/4"	16	244 00 025 2		0,35	75	20	350	58	49	96	51	31
32	1"	16	244 00 032 2		0,31	60	25	700	61	54	106	63	33
40	1 1/4"	16	244 00 040 2			30	32	1000	73	66	127	67	42
50	1 1/2"	16	244 00 050 2			20	40	1600	82	75	153	86	46
63	2"	16	244 00 063 2		1,53	12	50	3100	95	89	172	101	58

U-PVC Küresel Su Vanası (Çift Tarafı Piriç İç Diş)

U-PVC Both Sides Brass Female Threaded True Union Ball Valve For Water

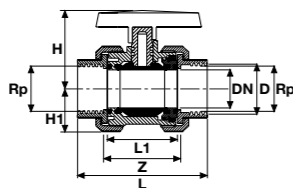

Çap Dia	Rp (Inch)	Basınç PN	Kod Code	Fiyat (Adet) Price (Pcs)	Kg/Adet Kg/Pcs	Koli/Adet Box/Pcs	DN (mm)	kv l/min	Z (mm)	L1 (mm)	L (mm)	H (mm)	H1 (mm)
20	1/2"	16	244 10 020 2		0,20	55	15	185	52	45	86	47	27
25	3/4"	16	244 10 025 2		0,35	75	20	350	58	49	96	51	31
32	1"	16	244 10 032 2		0,31	60	25	700	61	54	106	63	33
40	1 1/4"	16	244 10 040 2			30	32	1000	73	66	127	67	42
50	1 1/2"	16	244 10 050 2		1	20	40	1600	82	75	153	86	46
63	2"	16	244 10 063 2		1,53	12	50	3100	95	89	172	101	58

U-PVC Küresel Su Vanası (Tek Tarafı Piriç Dış Diş)

U-PVC One Side Brass Male Threaded Solvent Cement True Union Ball Valve For Water

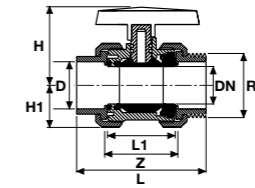

Çap Dia	Rp (Inch)	Basınç PN	Kod Code	Fiyat (Adet) Price (Pcs)	Kg/Adet Kg/Pcs	Koli/Adet Box/Pcs	DN (mm)	kv l/min	Z (mm)	L1 (mm)	L (mm)	H (mm)	H1 (mm)
20	1/2"	16	243 20 020 2		0,19	55	15	185	52	45	112	47	27
25	3/4"	16	243 20 025 2		0,26	75	20	350	58	49	113	51	31
32	1"	16	243 20 032 2		0,34	60	25	700	61	54	136	63	33
40	1 1/4"	16	243 20 040 2		0,57	30	32	1000	73	66	158	67	42
50	1 1/2"	16	243 20 050 2		0,86	20	40	1600	82	75	173	86	46
63	2"	16	243 20 063 2		1,45	12	50	3100	95	89	203	101	58

U-PVC İç Diş Küresel Su Vanası (Tek Taraf Piriç Dış Diş)

U-PVC One Side Female Threaded Other Side Brass Male Threaded True Union Ball Valve For Water

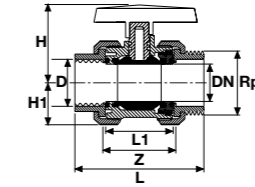

Çap Dia	Rp (Inch)	Basınç PN	Kod Code	Fiyat (Adet) Price (Pcs)	Kg/Adet Kg/Pcs	Koli/Adet Box/Pcs	DN (mm)	kv l/min	Z (mm)	L1 (mm)	L (mm)	H (mm)	H1 (mm)
20	1/2"	16	244 20 020 2		0,19	55	15	185	52	45	112	47	27
25	3/4"	16	244 20 025 2		0,26	75	20	350	58	49	113	51	31
32	1"	16	244 20 032 2		0,34	60	25	700	61	54	136	63	33
40	1 1/4"	16	244 20 040 2		0,57	30	32	1000	73	66	158	67	42
50	1 1/2"	16	244 20 050 2		0,87	20	40	1600	82	75	173	86	46
63	2"	16	244 20 063 2		1,48	12	50	3100	95	89	203	101	58

U-PVC Küresel Su Vanası (Tek Tarafı İç Diş Tek Tarafı Piriç Dış Diş)

U-PVC One Side Brass Female Threaded One Side Brass Male Threaded True Union Ball Valve For Water

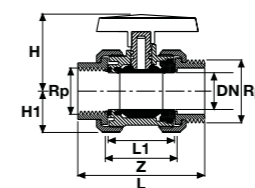

Çap Dia	Rp (Inch)	Basınç PN	Kod Code	Fiyat (Adet) Price (Pcs)	Kg/Adet Kg/Pcs	Koli/Adet Box/Pcs	DN (mm)	kv l/min	Z (mm)	L1 (mm)	L (mm)	H (mm)	H1 (mm)
20	1/2"	16	245 20 020 2		0,21	55	15	185	52	45	112	47	27
25	3/4"	16	245 20 025 2		0,36	75	20	350	58	49	113	51	31
32	1"	16	245 20 032 2		0,33	60	25	700	61	54	136	63	33
40	1 1/4"	16	245 20 040 2		0,66	30	32	1000	73	66	158	67	42
50	1 1/2"	16	245 20 050 2		0,96	20	40	1600	82	75	173	86	46
63	2"	16	245 20 063 2		1,62	12	50	3100	95	89	203	101	58

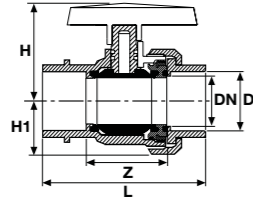
U-PVC Tek Tarafli Küresel Vana Çift Tarafli Yapıştırma
 U-PVC Solvent Cement Single Union Ball Valve

Çap Dia	Basınç PN	EPDM Conta Kod EPDM O-Ring Code	Fiyat (Adet) Price (Pcs)	Kg/Adet Kg/Pcs	Koli/Adet Box/Pcs	DN (mm)	Z (mm)	L (mm)	H (mm)	H1 (mm)
20	16	232 00 020 2		0,10	55	15	52	78	47	27
25	16	232 00 025 2		0,13	56	20	58	87	52	31
32	16	232 00 032 2		0,19	60	25	61	100	63	33
40	16	232 00 040 2		0,30	40	32	73	114	66	42
50	16	232 00 050 2		0,51	20	40	82	146	89	41
63	16	232 00 063 2		0,90	12	50	95	160	100	58
75	16	232 00 075 2		1,19	9	65	118	195	110	65
90	16	232 00 090 2		2,78	4	80	139	228	137	89
110	16	232 00 110 2		4,47	2	100	165	275	150	105

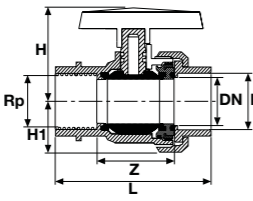
U-PVC Y.M. Küresel Tek Tarafli Vana Tek Taraf İçten Dişli
 U-PVC Solvent Cement Single Union Ball Valve One Side Female Threaded

Çap Dia	Rp (Inch)	Basınç PN	EPDM Conta Kod EPDM O-Ring Code	Fiyat (Adet) Price (Pcs)	Kg/Adet Kg/Pcs	Koli/Adet Box/Pcs	DN (mm)	Z (mm)	L (mm)	H (mm)	H1 (mm)
20	1/2"	16	232 20 020 2		0,10	55	15	52	78	47	27
25	3/4"	16	232 20 025 2		0,14	56	20	58	87	52	31
32	1"	16	232 20 032 2		0,19	60	25	61	100	63	33
40	1 1/4"	16	232 20 040 2		0,31	30	32	73	114	66	42
50	1 1/2"	16	232 20 050 2		0,50	20	40	82	146	89	41
63	2"	16	232 20 063 2		0,91	12	50	95	160	100	58
75	2 1/2"	16	232 20 075 2		1,12	9	65	118	195	110	65
90	3"	16	232 20 090 2		2,82	4	80	139	228	137	89
110	4"	16	232 20 110 2		4,30	2	100	165	275	150	105

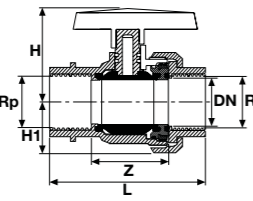
U-PVC Y.M. Küresel Tek Tarafli Vana Çift Taraf İçten Dişli
 U-PVC Solvent Cement Single Union Ball Valve Both Sides Female Threaded

Rp (Inch)	Basınç PN	EPDM Conta Kod EPDM O-Ring Code	Fiyat (Adet) Price (Pcs)	Kg/Adet Kg/Pcs	Koli/Adet Box/Pcs	DN (mm)	Z (mm)	L (mm)	H (mm)	H1 (mm)
1/2"	16	232 40 020 2		0,10	55	15	52	78	47	27
3/4"	16	232 40 025 2		0,14	50	20	58	87	52	31
1"	16	232 40 032 2		0,19	60	25	61	100	63	33
1 1/4"	16	232 40 040 2		0,30	30	32	73	114	66	42
1 1/2"	16	232 40 050 2		0,51	20	40	82	146	89	41
2"	16	232 40 063 2		0,91	12	50	95	160	100	58
2 1/2"	16	232 40 075 2		1,22	9	65	118	195	110	65
3"	16	232 40 090 2		2,82	4	80	139	228	137	89
4"	16	232 40 110 2		4,37	2	100	165	275	150	105

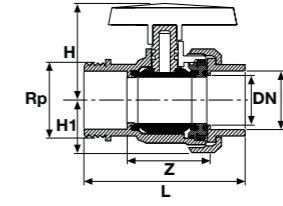
U-PVC Y.M. Küresel Tek Tarafli Vana Tek Taraf Dıştan Dişli
 U-PVC Solvent Cement Single Union Ball Valve One Side Male Threaded

Çap Dia	Rp (Inch)	Basınç PN	EPDM Conta Kod EPDM O-Ring Code	Fiyat (Adet) Price (Pcs)	Kg/Adet Kg/Pcs	Koli/Adet Box/Pcs	DN (mm)	Z (mm)	L (mm)	H (mm)	H1 (mm)
20	1/2"	16	232 60 020 2		0,11	55	15	50	82	47	27
25	3/4"	16	232 60 025 2		0,14	50	20	52	92	52	31
32	1"	16	232 60 032 2		0,19	60	25	58	105	63	33
40	1 1/4"	16	232 60 040 2		0,31	40	32	73	125	66	42
50	1 1/2"	16	232 60 050 2		0,52	20	40	82	146	89	41
63	2"	16	232 60 063 2		0,90	12	50	95	160	100	58
75	2 1/2"	16	232 60 075 2			9	65	118	195	110	65
90	3"	16	232 60 090 2			4	80	139	228	137	89
110	4"	16	232 60 110 2			2	100	165	275	150	105

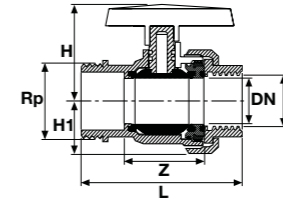
U-PVC Küresel Tek Tarafli Vana Tek Taraf İçten Dişli Tek Taraf Dış Dişli
 U-PVC One Side Female Threaded Other Side Male Threaded Single Union Ball Valve

Çap Dia	Rp (Inch)	Basınç PN	EPDM Conta Kod EPDM O-Ring Code	Fiyat (Adet) Price (Pcs)	Kg/Adet Kg/Pcs	Koli/Adet Box/Pcs	DN (mm)	Z (mm)	L (mm)	H (mm)	H1 (mm)
20	1/2"	16	232 80 020 2		0,10	55	15	50	85	47	27
25	3/4"	16	232 80 025 2		0,14	56	20	52	92	52	31
32	1"	16	232 80 032 2		0,19	60	25	58	107	63	33
40	1 1/4"	16	232 80 040 2		0,31	30	32	73	114	66	42
50	1 1/2"	16	232 80 050 2		0,52	20	40	82	140	89	41
63	2"	16	232 80 063 2		0,92	12	50	95	163	100	58
75	2 1/2"	16	232 80 075 2			9	65	118	195	110	65
90	3"	16	232 80 090 2			4	80	139	228	137	89
110	4"	16	232 80 110 2			2	100	165	275	150	105

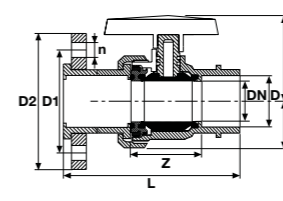
U-PVC Yapıştırma Mufli Küresel Tek Tarafli Vana Tek Taraf Flanş Çıkışlı
 U-PVC Solvent Cement Single Union Ball Valve One Side Flange Outlet

Çap Dia	Basınç PN	EPDM Conta Kod EPDM O-Ring Code	Fiyat (Adet) Price (Pcs)	Kg/Adet Kg/Pcs	Koli/Adet Box/Pcs	DN (mm)	Z (mm)	L (mm)	H (mm)	H1 (mm)	D1 (mm)	D2 (mm)	n (mm)	kv l/min
20	16	232 10 020 2			55	15	52	101	47	27	65	96	14x4	185
25	16	232 10 025 2			56	20	58	114	51	31	75	105	14x4	350
32	16	232 10 032 2			60	25	61	129	63	33	85	115	14x4	700
40	16	232 10 040 2			30	32	73	150	67	42	100	140	14x4	1000
50	16	232 10 050 2			24	40	82	188	86	46	100	150	18x4	1600
63	16	232 10 063 2			12	50	95	206	101	58	125	165	18x4	3100
75	16	232 10 075 2			9	65	118	242	110	64	145	185	22x4	5000
90	16	232 10 090 2			4	80	139	290	137	90	160	200	22x8	7000
110	16	232 10 110 2			2	100	165	353	150	106	180	220	24x8	11000

U-PVC Y.M. Küresel Asit Vanası

U-PVC Solvent Cement True Union Ball Valve For Acid

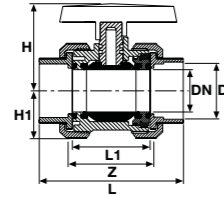

Düşük Dayanımlı Asit İçin
For Low Strength Acid

Yüksek Dayanımlı Asit İçin
For High Strength Acid

Çap Dia	Basınç PN	Kod / Code EPDM & PTFE O-Ring	Fiyat (Adet) Price (Pcs)	Kod / Code FPM & PTFE O-Ring	Fiyat (Adet) Price (Pcs)	Kg/Adet Kg/Pcs	Koli/Adet Box/Pcs	DN (mm)	Z (mm)	L1 (mm)	L (mm)	H (mm)	H1 (mm)	kv l/min
20	16	205 00 020 2		234 00 020 2		0,14	55	15	52	45	85	47	27	185
25	16	205 00 025 2		234 00 025 2		0,19	75	20	58	49	95	51	31	350
32	16	205 00 032 2		234 00 032 2		0,25	60	25	61	54	107	63	33	700
40	16	205 00 040 2		234 00 040 2		0,43	30	32	73	66	128	67	41	1000
50	16	205 00 050 2		234 00 050 2		0,66	24	40	82	75	154	86	46	1600
63	16	205 00 063 2		234 00 063 2		1,11	12	50	95	89	172	101	58	3100
75	16	205 00 075 2		234 00 075 2		1,48	6	65	118	111	196	110	73	5000
90	16	205 00 090 2		234 00 090 2		3,55	4	80	139	126	241	137	89	7000
110	16	205 00 110 2		234 00 110 2		5,48	2	100	165	153	289	150	105	11000

U-PVC Küresel Asit Vanası (Tek Taraf İçten Dişli)

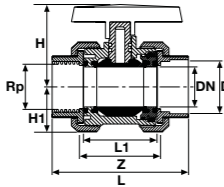
U-PVC One Side Female Threaded True Union Ball Valves For Acid



Düşük Dayanımlı Asit İçin
For Low Strength Acid

Yüksek Dayanımlı Asit İçin
For High Strength Acid

Çap Dia	Rp (Inch)	Basınç PN	Kod / Code EPDM & PTFE O-Ring	Fiyat (Adet) Price (Pcs)	Kod / Code FPM & PTFE O-Ring	Fiyat (Adet) Price (Pcs)	Kg/Adet Kg/Pcs	Koli/Adet Box/Pcs	DN (mm)	kv l/min	Z (mm)	L1 (mm)	L (mm)	H (mm)	H1 (mm)
20	1/2"	16	206 00 020 2		235 00 020 2		0,14	55	15	185	52	45	85	47	27
25	3/4"	16	206 00 025 2		235 00 025 2		0,19	75	20	350	58	49	95	51	31
32	1"	16	206 00 032 2		235 00 032 2		0,24	60	25	700	61	54	107	63	33
40	1 1/4"	16	206 00 040 2		235 00 040 2		0,42	30	32	1000	73	66	128	67	41
50	1 1/2"	16	206 00 050 2		235 00 050 2		0,66	24	40	1600	82	75	154	86	46
63	2"	16	206 00 063 2		235 00 063 2		1,19	12	50	3100	95	89	172	101	58
75	2 1/2"	16	206 00 075 2		235 00 075 2		1,51	6	65	5000	118	111	196	110	73
90	3"	16	206 00 090 2		235 00 090 2		3,57	4	80	7000	139	126	241	137	89
110	4"	16	206 00 110 2		235 00 110 2		5,36	2	100	11000	165	153	289	150	105

U-PVC Küresel Asit Vanası (Çift Taraf İçten Dişli)

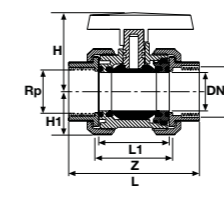
U-PVC Both Sides Female Threaded True Union Ball Valve For Acid



Düşük Dayanımlı Asit İçin
For Low Strength Acid

Yüksek Dayanımlı Asit İçin
For High Strength Acid

Rp (Inch)	Basınç PN	Kod / Code EPDM & PTFE O-Ring	Fiyat (Adet) Price (Pcs)	Kod / Code FPM & PTFE O-Ring	Fiyat (Adet) Price (Pcs)	Kg/Adet Kg/Pcs	Koli/Adet Box/Pcs	DN (mm)	Z (mm)	L1 (mm)	L (mm)	H (mm)	H1 (mm)	kv l/min
1/2"	16	207 00 020 2		236 00 020 2		0,14	55	15	52	45	85	47	27	185
3/4"	16	207 00 025 2		236 00 025 2		0,19	75	20	58	49	95	51	31	350
1"	16	207 00 032 2		236 00 032 2		0,24	60	25	61	54	107	63	33	700
1 1/4"	16	207 00 040 2		236 00 040 2		0,42	30	32	73	66	128	67	41	1000
1 1/2"	16	207 00 050 2		236 00 050 2		0,67	24	40	82	75	154	86	46	1600
2"	16	207 00 063 2		236 00 063 2		1,21	12	50	95	89	172	101	58	3100
2 1/2"	16	207 00 075 2		236 00 075 2		1,53	6	65	118	111	196	110	73	5000
3"	16	207 00 090 2		236 00 090 2		3,61	4	80	139	126	241	137	89	7000
4"	16	207 00 110 2		236 00 110 2		5,30	2	100	165	153	289	150	105	11000

U-PVC Küresel Asit Vanası (Çift Taraf Flanş Bağlantılı)

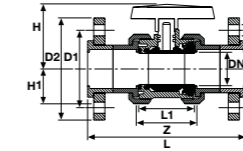
U-PVC Both Sides Female Threaded Ball Valves For Acid

Düşük Dayanımlı Asit İçin
For Low Strength Acid

Yüksek Dayanımlı Asit İçin
For High Strength Acid

Çap Dia	Basınç PN	Kod / Code EPDM PTFE O-Ring	Fiyat (Adet) Price (Pcs)	Kod / Code FPM & PTFE O-Ring	Fiyat (Adet) Price (Pcs)	Kg/Adet Kg/Pcs	Koli/Adet Box/Pcs	DN (mm)	Z (mm)	L1 (mm)	L (mm)	H (mm)	H1 (mm)	D1 (mm)	D2 (mm)	n (mmxAdet)
20	16	209 00 020 2		237 00 020 2		0,35	55	15	52	45	123	47	27	65	95	14 x 4
25	16	209 00 025 2		237 00 025 2		0,52	75	20	58	49	140	51	31	75	105	14 x 4
32	16	209 00 032 2		237 00 032 2		0,60	60	25	61	54	158	63	33	85	115	14 x 4
40	16	209 00 040 2		237 00 040 2		1,02	30	32	73	66	186	67	42	100	140	18 x 4
50	16	209 00 050 2		237 00 050 2		1,25	24	40	82	75	231	86	46	110	150	18 x 4
63	16	209 00 063 2		237 00 063 2		1,99	12	50	95	89	253	101	58	125	165	18 x 4
75	16	209 00 075 2		237 00 075 2		2,65	10	65	118	111	291	110	73	145	185	18 x 4
90	16	209 00 090 2		237 00 090 2		5,13	4	80	139	126	353	137	90	160	200	18 x 8
110	16	209 00 110 2		237 00 110 2		7,05	2	100	165	153	431	150	106	180	220	18 x 8

U-PVC Üç Yollu Küresel Asit Vanası (T Port)
U-PVC Three Ways Ball Valve (T Port)

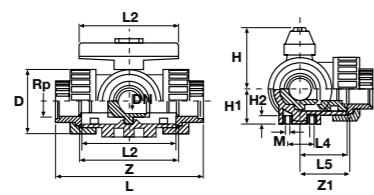

Çap Dia	Basınç PN	Kod Code	Fiyat (Adet) Price (Pcs)	Kg/Adet Kg/Pcs	Koli/Adet Box/Pcs	D (mm)	L (mm)	L1 (mm)	L2 (mm)	L3 (mm)	L4 (mm)	L5 (mm)	L6 (mm)	L7 (mm)	H (mm)
20	10	210 00 020 4		0,25	55	45	134	78	72	139	25	36	67	70	50
25	10	210 00 025 4		0,36	75	53	156	92	86	161	25	43	78	81	60
32	10	210 00 032 4		0,54	60	65	172	100	96	177	25	48	86	89	68
40	10	210 00 040 4		0,93	30	78	202	110	116	207	45	58	101	104	79
50	10	210 00 050 4		1,36	20	92	238	120	137	242	45	69	119	121	90
63	10	210 00 063 4		2,66	12	116	290	146	179	294	45	90	145	147	109

U-PVC Üç Yollu İçten Dişli Küresel Asit Vanası (T Port)
U-PVC Three Ways Female Threaded Ball Valve (T Port)

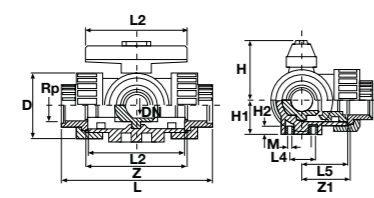

Çap Dia	Basınç PN	Kod Code	Fiyat (Adet) Price (Pcs)	Kg/Adet Kg/Pcs	Koli/Adet Box/Pcs	D (mm)	L (mm)	L1 (mm)	L2 (mm)	L4 (mm)	L5 (mm)	H (mm)	H1 (mm)
20	10	211 00 020 4		0,25	55	45	111	78	72	25	36	50	27
25	10	211 00 025 4		0,36	75	53	131	92	86	25	43	60	33
32	10	211 00 032 4		0,54	60	65	148	100	96	25	48	68	36
40	10	211 00 040 4		0,93	30	78	176	110	116	45	58	79	44
50	10	211 00 050 4		1,4	20	92	206	120	137	45	69	90	49
63	10	211 00 063 4		2,66	12	116	262	146	179	45	90	109	61

U-PVC Küresel Asit Vanası Çift Taraf Flanş Bağlantılı (Pozisyon Ayarlı)
U-PVC Both Sides Female Flanged True Union Ball Valve Position Regulated For Acid

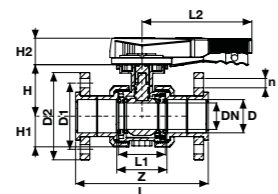

Düşük Dayanımlı Asit İçin For Low Strength Acid
Yüksek Dayanımlı Asit İçin For High Strength Acid

Çap Dia	Basınç PN	Kod / Code EPDM PTFE O-Ring	Fiyat (Adet) Price (Pcs)	Kod / Code FPM & PTFE O-Ring	Fiyat (Adet) Price (Pcs)	Koli/Adet Box/Pcs	DN (mm)	Z (mm)	L1 (mm)	L2 (mm)	L (mm)	H (mm)	H1 (mm)	H2 (mm)	D1 (mm)	D2 (mm)	n (mmxAdet)
63	16	209 10 063 2		237 10 063 2		12	50	98	87	207,5	172	101	58	48	125	165	18 x 4
75	16	209 10 075 2		237 10 075 2		9	65	119	98	207,5	196	110	73	50	145	185	18 x 4
90	16	209 10 090 2		237 10 090 2		4	80	156	126	207,5	241	137	90	52	160	200	18 x 8
110	16	209 10 110 2		237 10 110 2		2	100	185	150	259,5	289	150	106	52	180	220	18 x 8

U-PVC Küresel Asit Vanası (Pozisyon Ayarlı)
U-PVC True Union Ball Valve Position Regulated For Acid

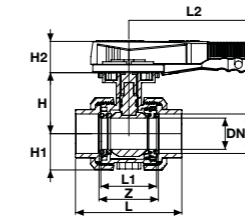

Düşük Dayanımlı Asit İçin For Low Strength Acid
Yüksek Dayanımlı Asit İçin For High Strength Acid

Çap Dia	Basınç PN	Kod / Code EPDM PTFE O-Ring	Fiyat (Adet) Price (Pcs)	Kod / Code FPM & PTFE O-Ring	Fiyat (Adet) Price (Pcs)	Kg/Adet Kg/Pcs	Koli/Adet Box/Pcs	DN (mm)	Z (mm)	L1 (mm)	L2 (mm)	L (mm)	H (mm)	H1 (mm)	H2 (mm)	kv l/min
63	16	205 10 063 2		234 10 063 2		1,16	12	50	98	87	207,5	172	101	58	48	3100
75	16	205 10 075 2		234 10 075 2		1,46	9	65	119	98	207,5	196	110	73	50	5000
90	16	205 10 090 2		234 10 090 2		3,51	4	80	156	126	207,5	241	137	89	52	7000
110	16	205 10 110 2		234 10 110 2		3,40	2	100	185	150	259,5	289	150	105	52	11000

U-PVC Küresel Asit Vanası Tek Taraf İç Dişli (Pozisyon Ayarlı)
U-PVC One Side Female Threaded True Union Ball Valve Position Regulated For Acid

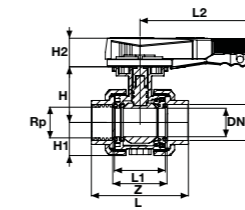

Düşük Dayanımlı Asit İçin For Low Strength Acid
Yüksek Dayanımlı Asit İçin For High Strength Acid

Çap Dia (Inch)	Rp (Inch)	Basınç PN	Kod / Code EPDM PTFE O-Ring	Fiyat (Adet) Price (Pcs)	Kod / Code FPM & PTFE O-Ring	Fiyat (Adet) Price (Pcs)	Kg/Adet Kg/Pcs	Koli/Adet Box/Pcs	DN (mm)	kv l/min	Z (mm)	L1 (mm)	L2 (mm)	L (mm)	H (mm)	H1 (mm)	H2 (mm)
63	2"	16	206 10 063 2		235 10 063 2		1,16	12	50	3100	98	87	207,5	172	101	58	48
75	2 1/2"	16	206 10 075 2		235 10 075 2		1,46	9	65	5000	119	98	207,5	196	110	73	50
90	3"	16	206 10 090 2		235 10 090 2		3,54	4	80	7000	156	126	207,5	241	137	89	52
110	4"	16	206 10 110 2		235 10 110 2		5,29	2	100	11000	185	150	259,5	289	150	105	52

U-PVC Küresel Asit Vanası Çift Taraf İç Dişli (Pozisyon Ayarlı)
U-PVC Both Sides Female Threaded True Union Ball Valve Position Regulated For Acid

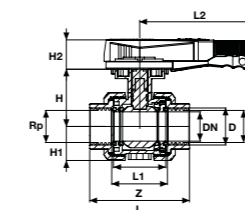

Düşük Dayanımlı Asit İçin For Low Strength Acid
Yüksek Dayanımlı Asit İçin For High Strength Acid

Rp (Inch)	Basınç PN	Kod / Code EPDM PTFE O-Ring	Fiyat (Adet) Price (Pcs)	Kod / Code FPM & PTFE O-Ring	Fiyat (Adet) Price (Pcs)	Kg/Adet Kg/Pcs	Koli/Adet Box/Pcs	DN (mm)	Z (mm)	L1 (mm)	L2 (mm)	L (mm)	H (mm)	H1 (mm)	H2 (mm)	kv l/min
2"	16	207 10 063 2		236 10 063 2		1,19	12	50	98	87	207,5	172	101	58	48	3100
2 1/2"	16	207 10 075 2		236 10 075 2		1,19	9	65	119	98	207,5	196	110	73	50	5000
3"	16	207 10 090 2		236 10 090 2		1,19	4	80	156	126	207,5	241	137	89	52	7000
4"	16	207 10 110 2		236 10 110 2		1,19	2	100	185	150	259,5	289	150	105	52	11000

Not / Note

U-PVC

AKTÜATÖRLÜ KÜRESEL VANA AKTUATOR BALL VALVE

ÜRETİM STANDARDI
PRODUCTION STANDARD | TS EN ISO 16135

ÇAP / SIZE Ø20 - Ø400



 **PIMTAŞ®**

Since 1977

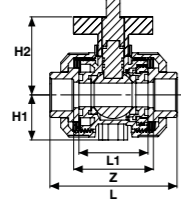
U-PVC Aktüatör Uyumlu Küresel Vana
 U-PVC Actuator Mountable True Union Ball Valves

Çap Dia	Basınç PN	DN (mm)	kv l/min	Z mm	L1 (mm)	L (mm)	H1 (mm)	H2 (mm)	ISO 5211 Flanş ISO 5211 Interface	Kg/Adet Kg/Pcs	Koli/Adet Box/Pcs
20	16	15	185	52	45	85	27	79	F 03	0,156	1
25	16	20	350	58	49	95	31	87	F 03	0,206	1
32	16	25	700	61	54	107	33	91	F 05	0,267	1
40	16	32	1000	73	66	128	41	107	F 05	0,442	1
50	16	40	1600	82	75	154	46	127	F 05	0,69	1
63	16	50	3100	95	89	172	58	164	F 07	1,145	1
75	16	65	5000	118	111	196	65	178	F 07	1,51	1
90	16	80	7000	139	126	241	89	226	F 07	3,58	1
110	16	100	11000	165	153	289	105	258	F 07	5,48	1

Su İçin
 For Water

Düşük Dayanımlı Asit İçin
 For Low Strength Acid

Yüksek Dayanımlı Asit İçin
 For High Strength Acid

Çap Dia	EPDM Conta Kod EPDM O-Ring Code	Fiyat (Adet) Price (Pcs)	EPDM & PTFE Conta Kod EPDM & PTFE O-Ring Code	Fiyat (Adet) Price (Pcs)	FPM & PTFE Conta Kod FPM & PTFE O-Ring Code	Fiyat (€/Adet) Price (€/Pcs)
20	300 01 020 2		300 02 020 2		301 02 020 2	
25	300 01 025 2		300 02 025 2		301 02 025 2	
32	300 01 032 2		300 02 032 2		301 02 032 2	
40	300 01 040 2		300 02 040 2		301 02 040 2	
50	300 01 050 2		300 02 050 2		301 02 050 2	
63	300 01 063 2		300 02 063 2		301 02 063 2	
75	300 01 075 2		300 02 075 2		301 02 075 2	
90	300 01 090 2		300 02 090 2		301 02 090 2	
110	300 01 110 2		300 02 110 2		301 02 110 2	

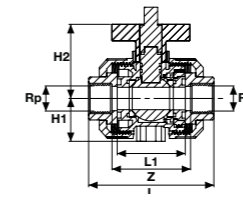
U-PVC Aktüatör Uyumlu Küresel Vana (Çift Taraf İçten Dişli)
 U-PVC Actuator Mountable True Union Ball Valves (Both Sides Female Threaded)

Çap Dia	Rp (Inch)	Basınç PN	DN (mm)	kv l/min	Z mm	L1 (mm)	L (mm)	H1 (mm)	H2 (mm)	ISO 5211 Flanş ISO 5211 Interface	Kg/Adet Kg/Pcs	Koli/Adet Box/Pcs
20	1/2"	16	15	185	52	45	85	27	79	F 03	0,15	1
25	3/4"	16	20	350	58	49	95	31	87	F 03	0,20	1
32	1"	16	25	700	61	54	107	33	91	F 05	0,26	1
40	1 1/4"	16	32	1000	73	66	128	41	107	F 05	0,44	1
50	1 1/2"	16	40	1600	82	75	154	46	127	F 05	0,69	1
63	2"	16	50	3100	95	89	172	58	164	F 07	1,14	1
75	2 1/2"	16	65	5000	118	111	196	65	178	F 07	1,51	1
90	3"	16	80	7000	139	126	241	89	226	F 07	3,58	1
110	4"	16	100	11000	165	153	289	105	258	F 07	5,48	1

Su İçin
 For Water

Düşük Dayanımlı Asit İçin
 For Low Strength Acid

Yüksek Dayanımlı Asit İçin
 For High Strength Acid

Rp (Inch)	EPDM Conta Kod EPDM O-Ring Code	Fiyat (Adet) Price (Pcs)	EPDM & PTFE Conta Kod EPDM & PTFE O-Ring Code	Fiyat (Adet) Price (Pcs)	FPM & PTFE Conta Kod FPM & PTFE O-Ring Code	Fiyat (Adet) Price (Pcs)
1/2"	300 05 020 2		300 06 020 2		301 06 020 2	
3/4"	300 05 025 2		300 06 025 2		301 06 025 2	
1"	300 05 032 2		300 06 032 2		301 06 032 2	
1 1/4"	300 05 040 2		300 06 040 2		301 06 040 2	
1 1/2"	300 05 050 2		300 06 050 2		301 06 050 2	
2"	300 05 063 2		300 06 063 2		301 06 063 2	
2 1/2"	300 05 075 2		300 06 075 2		301 06 075 2	
3"	300 05 090 2		300 06 090 2		301 06 090 2	
4"	300 05 110 2		300 06 110 2		301 06 110 2	

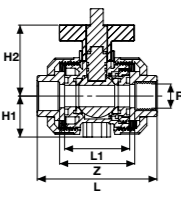
U-PVC Aktüatör Uyumlu Küresel Vana (Tek Taraf İçten Dişli)
 U-PVC Actuator Mountable True Union Ball Valves (One Sides Female Threaded)

Çap Dia	Rp (Inch)	Basınç PN	DN (mm)	kv l/min	Z mm	L1 (mm)	L (mm)	H1 (mm)	H2 (mm)	ISO 5211 Flanş ISO 5211 Interface	Kg/Adet Kg/Pcs	Koli/Adet Box/Pcs
20	1/2"	16	15	185	52	45	85	27	79	F 03	0,15	1
25	3/4"	16	20	350	58	49	95	31	87	F 03	0,20	1
32	1"	16	25	700	61	54	107	33	91	F 05	0,26	1
40	1 1/4"	16	32	1000	73	66	128	41	107	F 05	0,44	1
50	1 1/2"	16	40	1600	82	75	154	46	127	F 05	0,69	1
63	2"	16	50	3100	95	89	172	58	164	F 07	1,14	1
75	2 1/2"	16	65	5000	118	111	196	65	178	F 07	1,51	1
90	3"	16	80	7000	139	126	241	89	226	F 07	3,58	1
110	4"	16	100	11000	165	153	289	105	258	F 07	5,48	1

Su İçin
 For Water

Düşük Dayanımlı Asit İçin
 For Low Strength Acid

Yüksek Dayanımlı Asit İçin
 For High Strength Acid

Çap Dia	Rp (Inch)	EPDM Conta Kod EPDM O-Ring Code	Fiyat (Adet) Price (Pcs)	EPDM & PTFE Conta Kod EPDM & PTFE O-Ring Code	Fiyat (Adet) Price (Pcs)	FPM & PTFE Conta Kod FPM & PTFE O-Ring Code	Fiyat (Adet) Price (Pcs)
20	1/2"	300 03 020 2		300 04 020 2		301 04 020 2	
25	3/4"	300 03 025 2		300 04 025 2		301 04 025 2	
32	1"	300 03 032 2		300 04 032 2		301 04 032 2	
40	1 1/4"	300 03 040 2		300 04 040 2		301 04 040 2	
50	1 1/2"	300 03 050 2		300 04 050 2		301 04 050 2	
63	2"	300 03 063 2		300 04 063 2		301 04 063 2	
75	2 1/2"	300 03 075 2		300 04 075 2		301 04 075 2	
90	3"	300 03 090 2		300 04 090 2		301 04 090 2	
110	4"	300 03 110 2		300 04 110 2		301 04 110 2	

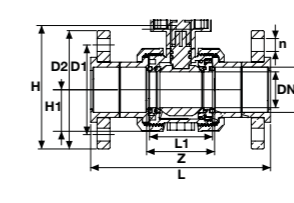
U-PVC Aktüatör Uyumlu Küresel Vana (Çift Taraf Flanş Bağlantılı)
 U-PVC Actuator Mountable True Union Ball Valves (Both Sides Flanged)

Çap Dia	Basınç PN	DN (mm)	kv l/min	Z (mm)	L1 (mm)	L (mm)	H (mm)	H1 (mm)	D1 (mm)	D2 (mm)	n (mm)	ISO 5211 Flanş ISO 5211 Interface	Kg/Adet Kg/Pcs	Koli/Adet Box/Pcs
20	16	15	185	52	45	123	131	27	65	96	14x4	F 03	0,37	1
25	16	20	350	58	49	140	133	31	75	105	14x4	F 03	0,49	1
32	16	25	700	61	54	158	141	33	85	115	14x4	F 05	0,68	1
40	16	32	1000	73	66	186	157	41	100	140	14x4	F 05	1,10	1
50	16	40	1600	82	75	231	182	46	100	150	18x4	F 05	1,48	1
63	16	50	3100	95	89	253	218	58	125	165	18x4	F 07	2,34	1
75	16	65	5000	118	111	291	228	65	145	185	22x4	F 07	3,03	1
90	16	80	7000	139	126	353	252	89	160	200	22x8	F 07	5,54	1
110	16	100	11000	165	153	431	276	105	180	220	24x8	F 07	8,10	1

Su İçin
 For Water

Düşük Dayanımlı Asit İçin
 For Low Strength Acid

Yüksek Dayanımlı Asit İçin
 For High Strength Acid

Çap Dia	EPDM Conta Kod EPDM O-Ring Code	Fiyat (Adet) Price (Pcs)	EPDM & PTFE Conta Kod EPDM & PTFE O-Ring Code	Fiyat (Adet) Price (Pcs)	FPM & PTFE Conta Kod FPM & PTFE O-Ring Code	Fiyat (Adet) Price (Pcs)
20	300 07 020 2		300 08 020 2		301 08 020 2	
25	300 07 025 2		300 08 025 2		301 08 025 2	
32	300 07 032 2		300 08 032 2		301 08 032 2	
40	300 07 040 2		300 08 040 2		301 08 040 2	
50	300 07 050 2		300 08 050 2		301 08 050 2	
63	300 07 063 2		300 08 063 2		301 08 063 2	
75	300 07 075 2		300 08 075 2		301 08 075 2	
90	300 07 090 2		300 08 090 2		301 08 090 2	
110	300 07 110 2		300 08 110 2		301 08 110 2	

U-PVC Elektrik Aktüatörlü Yapıştırma Muflu Küresel Vana 24 V DC/24 V AC
 U-PVC Electric Actuator Solvent Cement True Union Ball Valve 24 V DC/24 V AC

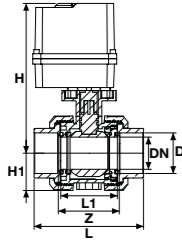

Çap Dia	Basınç PN	DN (mm)	kv l/min	Z (mm)	L1 (mm)	L (mm)	H (mm)	H1 (mm)	ISO 5211 Flanş ISO 5211 Interface	Kg/Adet Kg/Pcs	Koli/Adet Box/Pcs
20	16	15	185	52	45	85	27	27	F 03	1,44	1
25	16	20	350	58	49	95	31	31	F 03	1,49	1
32	16	25	700	61	54	107	33	33	F 05	1,54	1
40	16	32	1000	73	66	128	41	41	F 05	1,72	1
50	16	40	1600	82	75	154	46	46	F 05	1,95	1
63	16	50	3100	95	89	172	58	58	F 07	2,40	1
75	16	65	5000	118	111	196	65	65	F 07	3,96	1
90	16	80	7000	139	126	241	89	89	F 07	6,01	1
110	16	100	11000	165	153	289	105	105	F 07	7,91	1



Çap Dia	Su İçin For Water		Düşük Dayanımlı Asit İçin For Low Strength Acid		Yüksek Dayanımlı Asit İçin For High Strength Acid	
	EPDM Conta Kod EPDM O-Ring Code	Fiyat (Adet) Price (Pcs)	EPDM & PTFE Conta Kod EPDM & PTFE O-Ring Code	Fiyat (Adet) Price (Pcs)	FPM & PTFE Conta Kod FPM & PTFE O-Ring Code	Fiyat (Adet) Price (Pcs)
20	300 00 020 2		300 10 020 2		301 10 020 2	
25	300 00 025 2		300 10 025 2		301 10 025 2	
32	300 00 032 2		300 10 032 2		301 10 032 2	
40	300 00 040 2		300 10 040 2		301 10 040 2	
50	300 00 050 2		300 10 050 2		301 10 050 2	
63	300 00 063 2		300 10 063 2		301 10 063 2	
75	300 00 075 2		300 10 075 2		301 10 075 2	
90	300 00 090 2		300 10 090 2		301 10 090 2	
110	300 00 110 2		300 10 110 2		301 10 110 2	

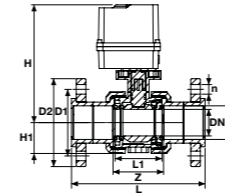

Çap Dia	Basınç PN	DN (mm)	kv l/min	Z (mm)	L1 (mm)	L (mm)	H (mm)	H1 (mm)	D1 (mm)	D2 (mm)	n (mm)	ISO 5211 Flanş ISO 5211 Interface	Kg/Adet Kg/Pcs	Koli/Adet Box/Pcs
20	16	15	185	60	48	123	209	27	65	96	14x4	F 03	1,66	1
25	16	20	350	58	45	140	215	31	75	105	14x4	F 03	1,77	1
32	16	25	700	68	49	158	225	33	85	115	14x4	F 05	1,96	1
40	16	32	1000	82	54	186	238	41	100	140	14x4	F 05	2,38	1
50	16	40	1600	94	65	231	253	46	100	150	18x4	F 05	2,74	1
63	16	50	3100	98	74	253	288	58	125	165	18x4	F 07	3,59	1
75	16	65	5000	119	87	291	305	65	145	185	22x4	F 07	5,49	1
90	16	80	7000	156	98	353	352	89	160	200	22x8	F 07	7,97	1
110	16	100	11000	185	150	431	385	105	180	220	24x8	F 07	10,5	1



Çap Dia	Su İçin For Water		Düşük Dayanımlı Asit İçin For Low Strength Acid		Yüksek Dayanımlı Asit İçin For High Strength Acid	
	EPDM Conta Kod EPDM O-Ring Code	Fiyat (Adet) Price (Pcs)	EPDM & PTFE Conta Kod EPDM & PTFE O-Ring Code	Fiyat (Adet) Price (Pcs)	FPM & PTFE Conta Kod FPM & PTFE O-Ring Code	Fiyat (Adet) Price (Pcs)
20	306 00 020 2		306 10 020 2		306 20 020 2	
25	306 00 025 2		306 10 025 2		306 20 025 2	
32	306 00 032 2		306 10 032 2		306 20 032 2	
40	306 00 040 2		306 10 040 2		306 20 040 2	
50	306 00 050 2		306 10 050 2		306 20 050 2	
63	306 00 063 2		306 10 063 2		306 20 063 2	
75	306 00 075 2		306 10 075 2		306 20 075 2	
90	306 00 090 2		306 10 090 2		306 20 090 2	
110	306 00 110 2		306 10 110 2		306 20 110 2	

U-PVC Elektrik Aktüatörlü Yapıştırma Muflu Küresel Vana 110-260 V AC
 U-PVC Electric Actuator Solvent Cement True Union Ball Valve 110-260 V AC

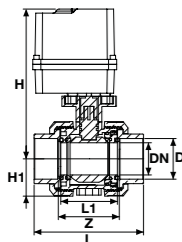

Çap Dia	Basınç PN	DN (mm)	kv l/min	Z (mm)	L1 (mm)	L (mm)	H (mm)	H1 (mm)	ISO 5211 Flanş ISO 5211 Interface	Kg/Adet Kg/Pcs	Koli/Adet Box/Pcs
20	16	15	185	52	45	85	209	27	F 03	1,44	1
25	16	20	350	58	49	95	215	31	F 03	1,49	1
32	16	25	700	61	54	107	225	33	F 05	1,54	1
40	16	32	1000	73	66	128	238	41	F 05	1,72	1
50	16	40	1600	82	75	154	253	46	F 05	1,95	1
63	16	50	3100	95	89	172	288	58	F 07	2,40	1
75	16	65	5000	118	111	196	305	65	F 07	3,96	1
90	16	80	7000	139	126	241	352	89	F 07	6,01	1
110	16	100	11000	165	153	289	385	105	F 07	7,91	1



Çap Dia	Su İçin For Water		Düşük Dayanımlı Asit İçin For Low Strength Acid		Yüksek Dayanımlı Asit İçin For High Strength Acid	
	EPDM Conta Kod EPDM O-Ring Code	Fiyat (Adet) Price (Pcs)	EPDM & PTFE Conta Kod EPDM & PTFE O-Ring Code	Fiyat (Adet) Price (Pcs)	FPM & PTFE Conta Kod FPM & PTFE O-Ring Code	Fiyat (Adet) Price (Pcs)
20	301 00 020 2		301 30 020 2		301 20 020 2	
25	301 00 025 2		301 30 025 2		301 20 025 2	
32	301 00 032 2		301 30 032 2		301 20 032 2	
40	301 00 040 2		301 30 040 2		301 20 040 2	
50	301 00 050 2		301 30 050 2		301 20 050 2	
63	301 00 063 2		301 30 063 2		301 20 063 2	
75	301 00 075 2		301 30 075 2		301 20 075 2	
90	301 00 090 2		301 30 090 2		301 20 090 2	
110	301 00 110 2		301 30 110 2		301 20 110 2	

U-PVC Elektrik Aktüatörlü Yapıştırma Muflu Çift Taraf Flanşlı Küresel Vana 110- 260 V AC
 U-PVC Both Sides Flanged Electric Actuator Ball Valve 110-260 V AC

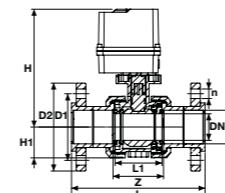

Çap Dia	Basınç PN	DN (mm)	kv l/min	Z (mm)	L1 (mm)	L (mm)	H (mm)	H1 (mm)	D1 (mm)	D2 (mm)	n (mm)	ISO 5211 Flanş ISO 5211 Interface	Kg/Adet Kg/Pcs	Koli/Adet Box/Pcs
20	16	15	185	60	48	123	209	27	65	96	14x4	F 03	1,66	1
25	16	20	350	58	45	140	215	31	75	105	14x4	F 03	1,77	1
32	16	25	700	68	49	158	225	33	85	115	14x4	F 05	1,96	1
40	16	32	1000	82	54	186	238	41	100	140	14x4	F 05	2,38	1
50	16	40	1600	94	65	231	253	46	100	150	18x4	F 05	2,74	1
63	16	50	3100	98	74	253	288	58	125	165	18x4	F 07	3,59	1
75	16	65	5000	119	87	291	305	65	145	185	22x4	F 07	5,49	1
90	16	80	7000	156	98	353	352	89	160	200	22x8	F 07	7,97	1
110	16	100	11000	185	150	431	385	105	180	220	24x8	F 07	10,5	1



Çap Dia	Su İçin For Water		Düşük Dayanımlı Asit İçin For Low Strength Acid		Yüksek Dayanımlı Asit İçin For High Strength Acid	
	EPDM Conta Kod EPDM O-Ring Code	Fiyat (Adet) Price (Pcs)	EPDM & PTFE Conta Kod EPDM & PTFE O-Ring Code	Fiyat (Adet) Price (Pcs)	FPM & PTFE Conta Kod FPM & PTFE O-Ring Code	Fiyat (Adet) Price (Pcs)
20	307 00 020 2		307 10 020 2		307 20 020 2	
25	307 00 025 2		307 10 025 2		307 20 025 2	
32	307 00 032 2		307 10 032 2		307 20 032 2	
40	307 00 040 2		307 10 040 2		307 20 040 2	
50	307 00 050 2		307 10 050 2		307 20 050 2	
63	307 00 063 2		307 10 063 2		307 20 063 2	
75	307 00 075 2		307 10 075 2		307 20 075 2	
90	307 00 090 2		307 10 090 2		307 20 090 2	
110	307 00 110 2		307 10 110 2		307 20 110 2	

U-PVC Elektrik Aktüatörlü Yapıştırma Muflu Küresel Vana Tek Taraf İç Dişli 24 V DC
 U-PVC True Union Ball Valve With Electric Actuator One Side Female Threaded 24 V DC

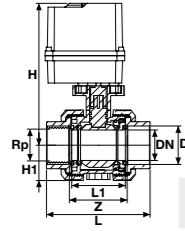
Çap Dia	Rp (Inch)	Basınç PN	DN (mm)	kv l/min	Z (mm)	L1 (mm)	L (mm)	H (mm)	H1 (mm)	ISO 5211 Flanş ISO 5211 Interface	Kg/Adet Kg/Pcs	Koli/Adet Box/Pcs
20	1/2"	16	15	185	52	45	85	209	27	F 03	1,44	1
25	3/4"	16	20	350	58	49	95	215	31	F 03	1,49	1
32	1"	16	25	700	61	54	107	225	33	F 05	1,54	1
40	1 1/4"	16	32	1000	73	66	128	238	41	F 05	1,72	1
50	1 1/2"	16	40	1600	82	75	154	253	46	F 05	1,95	1
63	2"	16	50	3100	95	89	172	288	58	F 07	2,40	1
75	2 1/2"	16	65	5000	118	111	196	305	65	F 07	3,96	1
90	3"	16	80	7000	139	126	241	352	89	F 07	6,01	1
110	4"	16	100	11000	165	153	289	385	105	F 07	7,91	1



Su İçin
For Water

Düşük Dayanımlı Asit İçin
For Low Strength Acid

Yüksek Dayanımlı Asit İçin
For High Strength Acid

Çap Dia	Rp (Inch)	EPDM Conta Kod EPDM O-Ring Code	Fiyat (Adet) Price (Pcs)	EPDM & PTFE Conta Kod EPDM & PTFE O-Ring Code	Fiyat (Adet) Price (Pcs)	FPM & PTFE Conta Kod FPM & PTFE O-Ring Code	Fiyat (Adet) Price (Pcs)
20	1/2"	302 00 020 2		302 10 020 2		302 20 020 2	
25	3/4"	302 00 025 2		302 10 025 2		302 20 025 2	
32	1"	302 00 032 2		302 10 032 2		302 20 032 2	
40	1 1/4"	302 00 040 2		302 10 040 2		302 20 040 2	
50	1 1/2"	302 00 050 2		302 10 050 2		302 20 050 2	
63	2"	302 00 063 2		302 10 063 2		302 20 063 2	
75	2 1/2"	302 00 075 2		302 10 075 2		302 20 075 2	
90	3"	302 00 090 2		302 10 090 2		302 20 090 2	
110	4"	302 00 110 2		302 10 110 2		302 20 110 2	

U-PVC Elektrik Aktüatörlü Yapıştırma Muflu Küresel Vana Çift Taraf İç Dişli 24 V DC/24 V AC
 U-PVC True Union Ball Valve With Electric Actuator Both Sides Female Threaded 24 V DC/24 V AC

Rp (Inch)	Basınç PN	DN (mm)	kv l/min	Z (mm)	L1 (mm)	L (mm)	H (mm)	H1 (mm)	ISO 5211 Flanş ISO 5211 Interface	Kg/Adet Kg/Pcs	Koli/Adet Box/Pcs
1/2"	16	15	185	52	45	85	209	27	F 03	1,44	1
3/4"	16	20	350	58	49	95	215	31	F 03	1,49	1
1"	16	25	700	61	54	107	225	33	F 05	1,54	1
1 1/4"	16	32	1000	73	66	128	238	41	F 05	1,72	1
1 1/2"	16	40	1600	82	75	154	253	46	F 05	1,95	1
2"	16	50	3100	95	89	172	288	58	F 07	2,40	1
2 1/2"	16	65	5000	118	111	196	305	65	F 07	3,96	1
3"	16	80	7000	139	126	241	352	89	F 07	6,01	1
4"	16	100	11000	165	153	289	385	105	F 07	7,91	1

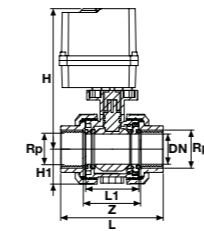

Su İçin
For Water

Düşük Dayanımlı Asit İçin
For Low Strength Acid

Yüksek Dayanımlı Asit İçin
For High Strength Acid

Rp (Inch)	EPDM Conta Kod EPDM O-Ring Code	Fiyat (Adet) Price (Pcs)	EPDM & PTFE Conta Kod EPDM & PTFE O-Ring Code	Fiyat (Adet) Price (Pcs)	FPM & PTFE Conta Kod FPM & PTFE O-Ring Code	Fiyat (Adet) Price (Pcs)
1/2"	304 00 020 2		304 10 020 2		304 20 020 2	
3/4"	304 00 025 2		304 10 025 2		304 20 025 2	
1"	304 00 032 2		304 10 032 2		304 20 032 2	
1 1/4"	304 00 040 2		304 10 040 2		304 20 040 2	
1 1/2"	304 00 050 2		304 10 050 2		304 20 050 2	
2"	304 00 063 2		304 10 063 2		304 20 063 2	
2 1/2"	304 00 075 2		304 10 075 2		304 20 075 2	
3"	304 00 090 2		304 10 090 2		304 20 090 2	
4"	304 00 110 2		304 10 110 2		304 20 110 2	

U-PVC Elektrik Aktüatörlü Yapıştırma Muflu Küresel Vana Tek Taraf İç Dişli 110-260 V AC
 U-PVC True Union Ball Valve With Electric Actuator One Side Female Threaded 110-260 V AC

Çap Dia	Rp (Inch)	Basınç PN	DN (mm)	kv l/min	Z (mm)	L1 (mm)	L (mm)	H (mm)	H1 (mm)	ISO 5211 Flanş ISO 5211 Interface	Kg/Adet Kg/Pcs	Koli/Adet Box/Pcs
20	1/2"	16	15	185	52	45	85	209	27	F 03	1,44	1
25	3/4"	16	20	350	58	49	95	215	31	F 03	1,49	1
32	1"	16	25	700	61	54	107	225	33	F 05	1,54	1
40	1 1/4"	16	32	1000	73	66	128	238	41	F 05	1,72	1
50	1 1/2"	16	40	1600	82	75	154	253	46	F 05	1,95	1
63	2"	16	50	3100	95	89	172	288	58	F 07	2,40	1
75	2 1/2"	16	65	5000	118	111	196	305	65	F 07	3,96	1
90	3"	16	80	7000	139	126	241	352	89	F 07	6,01	1
110	4"	16	100	11000	165	153	289	385	105	F 07	7,91	1

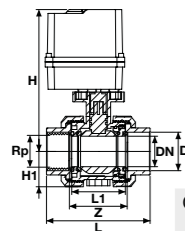

Su İçin
For Water

Düşük Dayanımlı Asit İçin
For Low Strength Acid

Yüksek Dayanımlı Asit İçin
For High Strength Acid

Çap Dia	Rp (Inch)	EPDM Conta Kod EPDM O-Ring Code	Fiyat (Adet) Price (Pcs)	EPDM & PTFE Conta Kod EPDM & PTFE O-Ring Code	Fiyat (Adet) Price (Pcs)	FPM & PTFE Conta Kod FPM & PTFE O-Ring Code	Fiyat (Adet) Price (Pcs)
20	1/2"	303 00 020 2		303 10 020 2		303 20 020 2	
25	3/4"	303 00 025 2		303 10 025 2		303 20 025 2	
32	1"	303 00 032 2		303 10 032 2		303 20 032 2	
40	1 1/4"	303 00 040 2		303 10 040 2		303 20 040 2	
50	1 1/2"	303 00 050 2		303 10 050 2		303 20 050 2	
63	2"	303 00 063 2		303 10 063 2		303 20 063 2	
75	2 1/2"	303 00 075 2		303 10 075 2		303 20 075 2	
90	3"	303 00 090 2		303 10 090 2		303 20 090 2	
110	4"	303 00 110 2		303 10 110 2		303 20 110 2	

U-PVC Elektrik Aktüatörlü Yapıştırma Muflu Küresel Vana Çift Taraf İç Dişli 110-260 V AC
 U-PVC True Union Ball Valve With Electric Actuator Both Sides Female Threaded 110-260 V AC

Rp (Inch)	Basınç PN	DN (mm)	kv l/min	Z (mm)	L1 (mm)	L (mm)	H (mm)	H1 (mm)	ISO 5211 Flanş ISO 5211 Interface	Kg/Adet Kg/Pcs	Koli/Adet Box/Pcs
1/2"	16	15	185	52	45	85	209	27	F 03	1,44	1
3/4"	16	20	350	58	49	95	215	31	F 03	1,49	1
1"	16	25	700	61	54	107	225	33	F 05	1,54	1
1 1/4"	16	32	1000	73	66	128	238	41	F 05	1,72	1
1 1/2"	16	40	1600	82	75	154	253	46	F 05	1,95	1
2"	16	50	3100	95	89	172	288	58	F 07	2,40	1
2 1/2"	16	65	5000	118	111	196	305	65	F 07	3,96	1
3"	16	80	7000	139	126	241	352	89	F 07	6,01	1
4"	16	100	11000	165	153	289	385	105	F 07	7,91	1

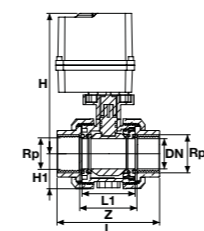

Su İçin
For Water

Düşük Dayanımlı Asit İçin
For Low Strength Acid

Yüksek Dayanımlı Asit İçin
For High Strength Acid

Rp (Inch)	EPDM Conta Kod EPDM O-Ring Code	Fiyat (Adet) Price (Pcs)	EPDM & PTFE Conta Kod EPDM & PTFE O-Ring Code	Fiyat (Adet) Price (Pcs)	FPM & PTFE Conta Kod FPM & PTFE O-Ring Code	Fiyat (Adet) Price (Pcs)
1/2"	305 00 020 2		305 10 020 2		305 20 020 2	
3/4"	305 00 025 2		305 10 025 2		305 20 025 2	
1"	305 00 032 2		305 10 032 2		305 20 032 2	
1 1/4"	305 00 040 2		305 10 040 2		305 20 040 2	
1 1/2"	305 00 050 2		305 10 050 2		305 20 050 2	
2"	305 00 063 2		305 10 063 2		305 20 063 2	
2 1/2"	305 00 075 2		305 10 075 2		305 20 075 2	
3"	305 00 090 2		305 10 090 2		305 20 090 2	
4"	305 00 110 2		305 10 110 2		305 20 110 2	

U-PVC Pnömatik Aktüatörlü Tek Etkili Küresel Vana

U-PVC Pneumatic Actuator True Union Ball Valve Single Effect



Çap Dia	Basınç PN	DN (mm)	kv l/min	Z (mm)	L1 (mm)	L (mm)	H (mm)	H1 (mm)	ISO 5211 Flanş ISO 5211 Interface	Kg/Adet Kg/Pcs	Koli/Adet Box/Pcs
20	16	15	185	52	45	85	131	27	F 03	0,61	1
25	16	20	350	58	49	95	133	31	F 03	0,66	1
32	16	25	700	61	54	107	141	33	F 05	0,71	1
40	16	32	1000	73	66	128	157	41	F 05	1,55	1
50	16	40	1600	82	75	154	182	46	F 05	1,78	1
63	16	50	3100	95	89	172	218	58	F 07	2,23	1
75	16	65	5000	118	111	196	228	65	F 07	3,43	1
90	16	80	7000	139	126	241	252	89	F 07	6,44	1
110	16	100	11000	165	153	289	276	105	F 07	9,19	1

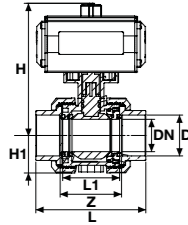

Su İçin
For Water

Düşük Dayanımlı Asit İçin
For Low Strength Acid

Yüksek Dayanımlı Asit İçin
For High Strength Acid

Çap Dia	EPDM Conta Kod EPDM O-Ring Code	Fiyat (Adet) Price (Pcs)	EPDM & PTFE Conta Kod EPDM & PTFE O-Ring Code	Fiyat (Adet) Price (Pcs)	FPM & PTFE Conta Kod FPM & PTFE O-Ring Code	Fiyat (Adet) Price (Pcs)
20	318 00 020 2		318 10 020 2		318 20 020 2	
25	318 00 025 2		318 10 025 2		318 20 025 2	
32	318 00 032 2		318 10 032 2		318 20 032 2	
40	318 00 040 2		318 10 040 2		318 20 040 2	
50	318 00 050 2		318 10 050 2		318 20 050 2	
63	318 00 063 2		318 10 063 2		318 20 063 2	
75	318 00 075 2		318 10 075 2		318 20 075 2	
90	318 00 090 2		318 10 090 2		318 20 090 2	
110	318 00 110 2		318 10 110 2		318 20 110 2	



Çap Dia	Basınç PN	DN (mm)	kv l/min	Z (mm)	L1 (mm)	L (mm)	H (mm)	H1 (mm)	D1 (mm)	D2 (mm)	n (mm)	ISO 5211 Flanş ISO 5211 Interface	Kg/Adet Kg/Pcs	Koli/Adet Box/Pcs
20	16	15	185	52	45	123	131	27	65	96	14x4	F 03	0,83	1
25	16	20	350	58	49	140	133	31	75	105	14x4	F 03	0,94	1
32	16	25	700	61	54	158	141	33	85	115	14x4	F 05	1,13	1
40	16	32	1000	73	66	186	157	41	100	140	14x4	F 05	2,21	1
50	16	40	1600	82	75	231	182	46	100	150	18x4	F 05	2,57	1
63	16	50	3100	95	89	253	218	58	125	165	18x4	F 07	3,42	1
75	16	65	5000	118	111	291	228	65	145	185	22x4	F 07	4,96	1
90	16	80	7000	139	126	353	252	89	160	200	22x8	F 07	8,40	1
110	16	100	11000	165	153	431	276	105	180	220	24x8	F 07	11,8	1

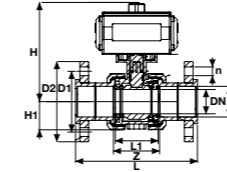

Su İçin
For Water

Düşük Dayanımlı Asit İçin
For Low Strength Acid

Yüksek Dayanımlı Asit İçin
For High Strength Acid

Çap Dia	EPDM Conta Kod EPDM O-Ring Code	Fiyat (Adet) Price (Pcs)	EPDM & PTFE Conta Kod EPDM & PTFE O-Ring Code	Fiyat (Adet) Price (Pcs)	FPM & PTFE Conta Kod FPM & PTFE O-Ring Code	Fiyat (Adet) Price (Pcs)
20	324 00 020 2		324 10 020 2		324 20 020 2	
25	324 00 025 2		324 10 025 2		324 20 025 2	
32	324 00 032 2		324 10 032 2		324 20 032 2	
40	324 00 040 2		324 10 040 2		324 20 040 2	
50	324 00 050 2		324 10 050 2		324 20 050 2	
63	324 00 063 2		324 10 063 2		324 20 063 2	
75	324 00 075 2		324 10 075 2		324 20 075 2	
90	324 00 090 2		324 10 090 2		324 20 090 2	
110	324 00 110 2		324 10 110 2		324 20 110 2	

U-PVC Pnömatik Aktüatörlü Çift Etkili Küresel Vana

U-PVC Pneumatic Actuator True Union Ball Valve Double Effect



Çap Dia	Basınç PN	DN (mm)	kv l/min	Z (mm)	L1 (mm)	L (mm)	H (mm)	H1 (mm)	ISO 5211 Flanş ISO 5211 Interface	Kg/Adet Kg/Pcs	Koli/Adet Box/Pcs
20	16	15	185	52	45	85	131	27	F 03	0,61	1
25	16	20	350	58	49	95	133	31	F 03	0,66	1
32	16	25	700	61	54	107	141	33	F 05	0,71	1
40	16	32	1000	73	66	128	157	41	F 05	1,55	1
50	16	40	1600	82	75	154	182	46	F 05	1,78	1
63	16	50	3100	95	89	172	218	58	F 07	2,23	1
75	16	65	5000	118	111	196	228	65	F 07	3,43	1
90	16	80	7000	139	126	241	252	89	F 07	6,44	1
110	16	100	11000	165	153	289	276	105	F 07	9,19	1

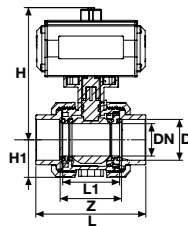

Su İçin
For Water

Düşük Dayanımlı Asit İçin
For Low Strength Acid

Yüksek Dayanımlı Asit İçin
For High Strength Acid

Çap Dia	EPDM Conta Kod EPDM O-Ring Code	Fiyat (Adet) Price (Pcs)	EPDM & PTFE Conta Kod EPDM & PTFE O-Ring Code	Fiyat (Adet) Price (Pcs)	FPM & PTFE Conta Kod FPM & PTFE O-Ring Code	Fiyat (Adet) Price (Pcs)
20	336 00 020 2		336 10 020 2		336 20 020 2	
25	336 00 025 2		336 10 025 2		336 20 025 2	
32	336 00 032 2		336 10 032 2		336 20 032 2	
40	336 00 040 2		336 10 040 2		336 20 040 2	
50	336 00 050 2		336 10 050 2		336 20 050 2	
63	336 00 063 2		336 10 063 2		336 20 063 2	
75	336 00 075 2		336 10 075 2		336 20 075 2	
90	336 00 090 2		336 10 090 2		336 20 090 2	
110	336 00 110 2		336 10 110 2		336 20 110 2	

U-PVC Çift Etkili Pnömatik Aktüatörlü Küresel Vana Çift Taraf Flanş Bağlantılı

U-PVC Pneumatic Actuator True Union Ball Valve Both Sides Flanged Double Effect



Çap Dia	Basınç PN	DN (mm)	kv l/min	Z (mm)	L1 (mm)	L (mm)	H (mm)	H1 (mm)	D1 (mm)	D2 (mm)	n (mm)	ISO 5211 Flanş ISO 5211 Interface	Kg/Adet Kg/Pcs	Koli/Adet Box/Pcs
20	16	15	185	52	45	123	131	27	65	96	14x4	F 03	0,83	1
25	16	20	350	58	49	140	133	31	75	105	14x4	F 03	0,94	1
32	16	25	700	61	54	158	141	33	85	115	14x4	F 05	1,13	1
40	16	32	1000	73	66	186	157	41	100	140	14x4	F 05	2,21	1
50	16	40	1600	82	75	231	182	46	100	150	18x4	F 05	2,57	1
63	16	50	3100	95	89	253	218	58	125	165	18x4	F 07	3,42	1
75	16	65	5000	118	111	291	228	65	145	185	22x4	F 07	4,96	1
90	16	80	7000	139	126	353	252	89	160	200	22x8	F 07	8,40	1
110	16	100	11000	165	153	431	276	105	180	220	24x8	F 07	11,8	1

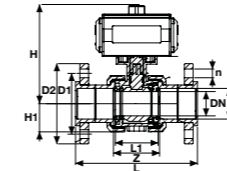

Su İçin
For Water

Düşük Dayanımlı Asit İçin
For Low Strength Acid

Yüksek Dayanımlı Asit İçin
For High Strength Acid

Çap Dia	EPDM Conta Kod EPDM O-Ring Code	Fiyat (Adet) Price (Pcs)	EPDM & PTFE Conta Kod EPDM & PTFE O-Ring Code	Fiyat (Adet) Price (Pcs)	FPM & PTFE Conta Kod FPM & PTFE O-Ring Code	Fiyat (Adet) Price (Pcs)
20	336 30 020 2		336 40 020 2		336 50 020 2	
25	336 30 025 2		336 40 025 2		336 50 025 2	
32	336 30 032 2		336 40 032 2		336 50 032 2	
40	336 30 040 2		336 40 040 2		336 50 040 2	
50	336 30 050 2		336 40 050 2		336 50 050 2	
63	336 30 063 2		336 40 063 2		336 50 063 2	
75	336 30 075 2		336 40 075 2		336 50 075 2	
90	336 30 090 2		336 40 090 2		336 50 090 2	
110	336 30 110 2		336 40 110 2		336 50 110 2	

U-PVC Pnömatik Aktüatörlü Tek Etkili Küresel Vana (Tek Taraf İçten Dışlı)

U-PVC Pneumatic Actuator True Union Ball Valve One Side Female Threaded Single Effect

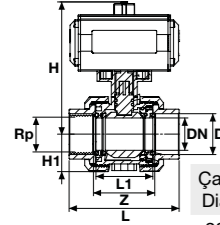

Çap Dia (mm)	Rp (Inch)	Basınç PN	DN (mm)	kv l/min	Z (mm)	L1 (mm)	L (mm)	H (mm)	H1 (mm)	ISO 5211 Flanş ISO 5211 Interface	Kg/Adet Kg/Pcs	Koli/Adet Box/Pcs
20	1/2"	16	15	185	52	45	85	131	27	F 03	0,61	1
25	3/4"	16	20	350	58	49	95	133	31	F 03	0,66	1
32	1"	16	25	700	61	54	107	141	33	F 05	0,71	1
40	1 1/4"	16	32	1000	73	66	128	157	41	F 05	1,55	1
50	1 1/2"	16	40	1600	82	75	154	182	46	F 05	1,78	1
63	2"	16	50	3100	95	89	172	218	58	F 07	2,23	1
75	2 1/2"	16	65	5000	118	111	196	228	65	F 07	3,43	1
90	3"	16	80	7000	139	126	241	252	89	F 07	6,44	1
110	4"	16	100	11000	165	153	289	276	105	F 07	9,19	1

Su İçin
For Water

Düşük Dayanımlı Asit İçin
For Low Strength Acid

Yüksek Dayanımlı Asit İçin
For High Strength Acid

Çap Dia (mm)	Rp (Inch)	EPDM Conta Kod EPDM O-Ring Code	Fiyat (Adet) Price (Pcs)	EPDM & PTFE Conta Kod EPDM & PTFE O-Ring Code	Fiyat (Adet) Price (Pcs)	FPM & PTFE Conta Kod FPM & PTFE O-Ring Code	Fiyat (Adet) Price (Pcs)
20	1/2"	336 60 020 2		336 70 020 2		336 80 020 2	
25	3/4"	336 60 025 2		336 70 025 2		336 80 025 2	
32	1"	336 60 032 2		336 70 032 2		336 80 032 2	
40	1 1/4"	336 60 040 2		336 70 040 2		336 80 040 2	
50	1 1/2"	336 60 050 2		336 70 050 2		336 80 050 2	
63	2"	336 60 063 2		336 70 063 2		336 80 063 2	
75	2 1/2"	336 60 075 2		336 70 075 2		336 80 075 2	
90	3"	336 60 090 2		336 70 090 2		336 80 090 2	
110	4"	336 60 110 2		336 70 110 2		336 80 110 2	

U-PVC Pnömatik Aktüatörlü Tek Etkili Küresel Vana (Çift Taraf İçten Dışlı)

U-PVC Pneumatic Actuator True Union Ball Valve Both Sides Female Threaded Single Effect

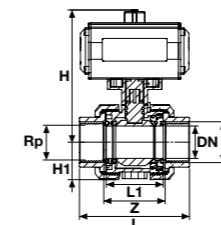

Rp (Inch)	Basınç PN	DN (mm)	kv l/min	Z (mm)	L1 (mm)	L (mm)	H (mm)	H1 (mm)	ISO 5211 Flanş ISO 5211 Interface	Kg/Adet Kg/Pcs	Koli/Adet Box/Pcs
1/2"	16	15	185	52	45	85	131	27	F 03	0,61	1
3/4"	16	20	350	58	49	95	133	31	F 03	0,66	1
1"	16	25	700	61	54	107	141	33	F 05	0,71	1
1 1/4"	16	32	1000	73	66	128	157	41	F 05	1,55	1
1 1/2"	16	40	1600	82	75	154	182	46	F 05	1,78	1
2"	16	50	3100	95	89	172	218	58	F 07	2,23	1
2 1/2"	16	65	5000	118	111	196	228	65	F 07	3,43	1
3"	16	80	7000	139	126	241	252	89	F 07	6,44	1
4"	16	100	11000	165	153	289	276	105	F 07	9,19	1

Su İçin
For Water

Düşük Dayanımlı Asit İçin
For Low Strength Acid

Yüksek Dayanımlı Asit İçin
For High Strength Acid

Rp (Inch)	EPDM Conta Kod EPDM O-Ring Code	Fiyat (Adet) Price (Pcs)	EPDM & PTFE Conta Kod EPDM & PTFE O-Ring Code	Fiyat (Adet) Price (Pcs)	FPM & PTFE Conta Kod FPM & PTFE O-Ring Code	Fiyat (Adet) Price (Pcs)
1/2"	337 30 020 2		337 40 020 2		337 50 020 2	
3/4"	337 30 025 2		337 40 025 2		337 50 025 2	
1"	337 30 032 2		337 40 032 2		337 50 032 2	
1 1/4"	337 30 040 2		337 40 040 2		337 50 040 2	
1 1/2"	337 30 050 2		337 40 050 2		337 50 050 2	
2"	337 30 063 2		337 40 063 2		337 50 063 2	
2 1/2"	337 30 075 2		337 40 075 2		337 50 075 2	
3"	337 30 090 2		337 40 090 2		337 50 090 2	
4"	337 30 110 2		337 40 110 2		337 50 110 2	

U-PVC Pnömatik Aktüatörlü Çift Etkili Küresel Vana (Tek Taraf İçten Dışlı)

U-PVC Pneumatic Actuator True Union Ball Valve One Side Female Threaded Double Effect

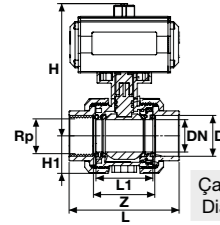

Çap Dia (mm)	Rp (Inch)	Basınç PN	DN (mm)	kv l/min	Z (mm)	L1 (mm)	L (mm)	H (mm)	H1 (mm)	ISO 5211 Flanş ISO 5211 Interface	Kg/Adet Kg/Pcs	Koli/Adet Box/Pcs
20	1/2"	16	15	185	52	45	85	131	27	F 03	0,61	1
25	3/4"	16	20	350	58	49	95	133	31	F 03	0,66	1
32	1"	16	25	700	61	54	107	141	33	F 05	0,71	1
40	1 1/4"	16	32	1000	73	66	128	157	41	F 05	1,55	1
50	1 1/2"	16	40	1600	82	75	154	182	46	F 05	1,78	1
63	2"	16	50	3100	95	89	172	218	58	F 07	2,23	1
75	2 1/2"	16	65	5000	118	111	196	228	65	F 07	3,43	1
90	3"	16	80	7000	139	126	241	252	89	F 07	6,44	1
110	4"	16	100	11000	165	153	289	276	105	F 07	9,19	1

Su İçin
For Water

Düşük Dayanımlı Asit İçin
For Low Strength Acid

Yüksek Dayanımlı Asit İçin
For High Strength Acid

Çap Dia (mm)	Rp (Inch)	EPDM Conta Kod EPDM O-Ring Code	Fiyat (Adet) Price (Pcs)	EPDM & PTFE Conta Kod EPDM & PTFE O-Ring Code	Fiyat (Adet) Price (Pcs)	FPM & PTFE Conta Kod FPM & PTFE O-Ring Code	Fiyat (Adet) Price (Pcs)
20	1/2"	339 00 020 2		339 10 020 2		339 20 020 2	
25	3/4"	339 00 025 2		339 10 025 2		339 20 025 2	
32	1"	339 00 032 2		339 10 032 2		339 20 032 2	
40	1 1/4"	339 00 040 2		339 10 040 2		339 20 040 2	
50	1 1/2"	339 00 050 2		339 10 050 2		339 20 050 2	
63	2"	339 00 063 2		339 10 063 2		339 20 063 2	
75	2 1/2"	339 00 075 2		339 10 075 2		339 20 075 2	
90	3"	339 00 090 2		339 10 090 2		339 20 090 2	
110	4"	339 00 110 2		339 10 110 2		339 20 110 2	

U-PVC Pnömatik Aktüatörlü Çift Etkili Küresel Vana (Çift Taraf İçten Dışlı)

U-PVC Pneumatic Actuator True Union Ball Valve Both Sides Female Threaded Double Effect

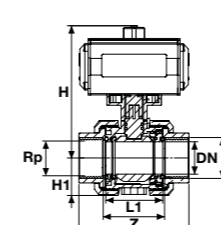

Rp (Inch)	Basınç PN	DN (mm)	kv l/min	Z (mm)	L1 (mm)	L (mm)	H (mm)	H1 (mm)	ISO 5211 Flanş ISO 5211 Interface	Kg/Adet Kg/Pcs	Koli/Adet Box/Pcs
1/2"	16	15	185	52	45	85	131	27	F 03	0,61	1
3/4"	16	20	350	58	49	95	133	31	F 03	0,66	1
1"	16	25	700	61	54	107	141	33	F 05	0,71	1
1 1/4"	16	32	1000	73	66	128	157	41	F 05	1,55	1
1 1/2"	16	40	1600	82	75	154	182	46	F 05	1,78	1
2"	16	50	3100	95	89	172	218	58	F 07	2,23	1
2 1/2"	16	65	5000	118	111	196	228	65	F 07	3,43	1
3"	16	80	7000	139	126	241	252	89	F 07	6,44	1
4"	16	100	11000	165	153	289	276	105	F 07	9,19	1

Su İçin
For Water

Düşük Dayanımlı Asit İçin
For Low Strength Acid

Yüksek Dayanımlı Asit İçin
For High Strength Acid

Rp (Inch)	EPDM Conta Kod EPDM O-Ring Code	Fiyat (Adet) Price (Pcs)	EPDM & PTFE Conta Kod EPDM & PTFE O-Ring Code	Fiyat (Adet) Price (Pcs)	FPM & PTFE Conta Kod FPM & PTFE O-Ring Code	Fiyat (Adet) Price (Pcs)
1/2"	337 60 020 2		337 70 020 2		337 80 020 2	
3/4"	337 60 025 2		337 70 025 2		337 80 025 2	
1"	337 60 032 2		337 70 032 2		337 80 032 2	
1 1/4"	337 60 040 2		337 70 040 2		337 80 040 2	
1 1/2"	337 60 050 2		337 70 050 2		337 80 050 2	
2"	337 60 063 2		337 70 063 2		337 80 063 2	
2 1/2"	337 60 075 2		337 70 075 2		337 80 075 2	
3"	337 60 090 2		337 70 090 2		337 80 090 2	
4"	337 60 110 2		337 70 110 2		337 80 110 2	

Not / Note

HDPE

BORU

PIPE

ÜRETİM STANDARDI

PRODUCTION STANDARD

TS EN 12201-2

ÇAP / SIZE Ø20 - Ø630



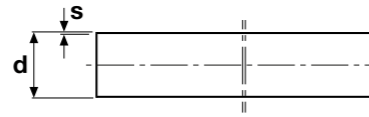

PE 100 Boru SDR 41 - PN4
 PE 100 Pipe SDR 41 - PN4

Çap Dia	Kod / Code 6 m	Fiyat (m) Price (m)	Kod / Code 12 m	Fiyat (m) Price (m)	s (mm) Et Kalınlığı Wall thickness	Kg / Mt
90	900 04 090 2		12900 04 090 2		2,3	0,643
110	900 04 110 2		12900 04 110 2		2,7	0,943
125	900 04 125 2		12900 04 125 2		3,1	1,23
140	900 04 140 2		12900 04 140 2		3,5	1,54
160	900 04 160 2		12900 04 160 2		4	2
180	900 04 180 2		12900 04 180 2		4,4	2,49
200	900 04 200 2		12900 04 200 2		4,9	3,05
225	900 04 225 2		12900 04 225 2		5,5	3,86
250	900 04 250 2		12900 04 250 2		6,2	4,83
280	900 04 280 2		12900 04 280 2		6,9	5,98
315	900 04 315 2		12900 04 315 2		7,7	7,52
355	900 04 355 2		12900 04 355 2		8,7	9,55
400	900 04 400 2		12900 04 400 2		9,8	12,1
450	900 04 450 2		12900 04 450 2		11	1,3
500	900 04 500 2		12900 04 500 2		12,3	19
560	900 04 560 2		12900 04 560 2		13,7	23,6
630	900 04 630 2		12900 04 630 2		15,4	29,9

PE 100 Boru SDR 33 - PN5
 PE 100 Pipe SDR 33 - PN5

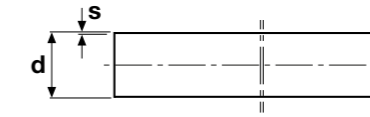
Çap Dia	Kod / Code 6 m	Fiyat (m) Price (m)	Kod / Code 12 m	Fiyat (m) Price (m)	s (mm) Et Kalınlığı Wall thickness	Kg / Mt
63	900 33 063 2		12900 33 063 2		2	0,399
75	900 33 075 2		12900 33 075 2		2,3	0,551
90	900 33 090 2		12900 33 090 2		2,8	0,791
110	900 33 110 2		12900 33 110 2		3,4	1,17
125	900 33 125 2		12900 33 125 2		3,9	1,51
140	900 33 140 2		12900 33 140 2		4,3	1,88
160	900 33 160 2		12900 33 160 2		4,9	2,42
180	900 33 180 2		12900 33 180 2		5,5	3,07
200	900 33 200 2		12900 33 200 2		6,2	3,84
225	900 33 225 2		12900 33 225 2		6,9	4,77
250	900 33 250 2		12900 33 250 2		7,7	5,92
280	900 33 280 2		12900 33 280 2		8,6	7,4
315	900 33 315 2		12900 33 315 2		9,7	9,37
355	900 33 355 2		12900 33 355 2		10,9	11,8
400	900 33 400 2		12900 33 400 2		12,3	15,1
450	900 33 450 2		12900 33 450 2		13,8	19
500	900 33 500 2		12900 33 500 2		15,3	23,4
560	900 33 560 2		12900 33 560 2		17,2	29,4
630	900 33 630 2		12900 33 630 2		19,3	27,1

PE 100 Boru SDR 26 - PN6
 PE 100 Pipe SDR 26 - PN6

Çap Dia	Kod / Code 6 m	Fiyat (m) Price (m)	Kod / Code 12 m	Fiyat (m) Price (m)	s (mm) Et Kalınlığı Wall thickness	Kg / Mt
50	906 00 050 2		906 12 050 2		2	0,314
63	906 00 063 2		906 12 063 2		2,5	0,494
75	906 00 075 2		906 12 075 2		2,9	0,675
90	906 00 090 2		906 12 090 2		3,5	0,978
110	906 00 110 2		906 12 110 2		4,2	1,43
125	906 00 125 2		906 12 125 2		4,8	1,84
140	906 00 140 2		906 12 140 2		5,4	2,32
160	906 00 160 2		906 12 160 2		6,2	3,04
180	906 00 180 2		906 12 180 2		6,9	3,79
200	906 00 200 2		906 12 200 2		7,7	4,69
225	906 00 225 2		906 12 225 2		8,6	5,89
250	906 00 250 2		906 12 250 2		9,6	7,3
280	906 00 280 2		906 12 280 2		10,7	9,1
315	906 00 315 2		906 12 315 2		12,1	11,6
355	906 00 355 2		906 12 355 2		13,6	14,6
400	906 00 400 2		906 12 400 2		15,3	18,6
450	906 00 450 2		906 12 450 2		17,2	23,5
500	906 00 500 2		906 12 500 2		19,1	28,9
560	906 00 560 2		906 12 560 2		21,4	36,2
630	906 00 630 2		906 12 630 2		24,1	45,9

PE 100 Boru SDR 21 - PN8
 PE 100 Pipe SDR 21 - PN8

Çap Dia	Kod / Code 6 m	Fiyat (m) Price (m)	Kod / Code 12 m	Fiyat (m) Price (m)	s (mm) Et Kalınlığı Wall thickness	Kg / Mt
40	900 08 040 2		900 21 040 2		2	0,239
50	900 08 050 2		900 21 050 2		2,4	0,359
63	900 08 063 2		900 21 063 2		3	0,565
75	900 08 075 2		900 21 075 2		3,6	0,807
90	900 08 090 2		900 21 090 2		4,3	1,16
110	900 08 110 2		900 21 110 2		5,3	1,74
125	900 08 125 2		900 21 125 2		6	2,2
140	900 08 140 2		900 21 140 2		6,7	2,8
160	900 08 160 2		900 21 160 2		7,7	3,68
180	900 08 180 2		900 21 180 2		8,6	4,63
200	900 08 200 2		900 21 200 2		9,6	5,73
225	900 08 225 2		900 21 225 2		10,8	7,26
250	900 08 250 2		900 21 250 2		11,9	8,9
280	900 08 280 2		900 21 280 2		13,4	11,22
315	900 08 315 2		900 21 315 2		15	14,13
355	900 08 355 2		900 21 355 2		16,9	17,94
400	900 08 400 2		900 21 400 2		19,1	22,84
450	900 08 450 2		900 21 450 2		21,5	28,9
500	900 08 500 2		900 21 500 2		23,9	35,7
560	900 08 560 2		900 21 560 2		26,7	44,7
630	900 08 630 2		900 21 630 2		30	56,5

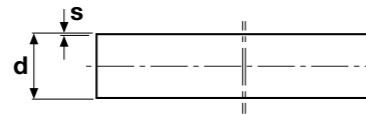
PE 100 Boru SDR 17 - PN10
 PE 100 Pipe SDR 17 - PN10

Çap Dia	Kod / Code 6 m	Fiyat (m) Price (m)	Kod / Code 12 m	Fiyat (m) Price (m)	s (mm) Et Kalınlığı Wall thickness	Kg / Mt
20	900 00 020 2		900 12 020 2			
25	900 00 025 2		900 12 025 2			
32	900 00 032 2		900 12 032 2		2	0,187
40	900 00 040 2		900 12 040 2		2,4	0,295
50	900 00 050 2		900 12 050 2		3	0,453
63	900 00 063 2		900 12 063 2		3,8	0,721
75	900 00 075 2		900 12 075 2		4,5	1,02
90	900 00 090 2		900 12 090 2		5,4	1,46
110	900 00 110 2		900 12 110 2		6,6	2,17
125	900 00 125 2		900 12 125 2		7,4	2,76
140	900 00 140 2		900 12 140 2		8,3	3,46
160	900 00 160 2		900 12 160 2		9,5	4,52
180	900 00 180 2		900 12 180 2		10,7	5,71
200	900 00 200 2		900 12 200 2		11,9	7,05
225	900 00 225 2		900 12 225 2		13,4	8,93
250	900 00 250 2		900 12 250 2		14,8	11
280	900 00 280 2		900 12 280 2		16,6	13,7
315	900 00 315 2		900 12 315 2		18,7	17,4
355	900 00 355 2		900 12 355 2		21,1	22,1
400	900 00 400 2		900 12 400 2		23,7	28
450	900 00 450 2		900 12 450 2		26,7	35,4
500	900 00 500 2		900 12 500 2		29,7	43,8
560	900 00 560 2		900 12 560 2		33,2	54,8
630	900 00 630 2		900 12 630 2		37,2	69,4

PE 100 Boru SDR 13,6 - PN12,5
 PE 100 Pipe SDR 13,6 - PN12,5

Çap Dia	Kod / Code 6 m	Fiyat (m) Price (m)	Kod / Code 12 m	Fiyat (m) Price (m)	s (mm) Et Kalınlığı Wall thickness	Kg / Mt
25	900 10 025 2		12900 10 025 2		2,0	0,152
32	900 10 032 2		12900 10 032 2		2,4	0,232
40	900 10 040 2		12900 10 040 2		3,0	0,356
50	900 10 050 2		12900 10 050 2		3,7	0,549
63	900 10 063 2		12900 10 063 2		4,7	0,873
75	900 10 075 2		12900 10 075 2		5,6	1,24
90	900 10 090 2		12900 10 090 2		6,7	1,77
110	900 10 110 2		12900 10 110 2		8,1	2,62
125	900 10 125 2		12900 10 125 2		9,2	3,37
140	900 10 140 2		12900 10 140 2		10,03	4,22
160	900 10 160 2		12900 10 160 2		11,8	5,5
180	900 10 180 2		12900 10 180 2		13,3	6,98
200	900 10 200 2		12900 10 200 2		14,7	8,56
225	900 10 225 2		12900 10 225 2		16,6	10,9
250	900 10 250 2		12900 10 250 2		18,4	13,4
280	900 10 280 2		12900 10 280 2		20,06	16,8
315	900 10 315 2		12900 10 315 2		23,2	21,2
355	900 10 355 2		12900 10 355 2		26,1	26,9
400	900 10 400 2		12900 10 400 2		29,4	34,1
450	900 10 450 2		12900 10 450 2		33,1	43,2
500	900 10 500 2		12900 10 500 2		36,8	53,3
560	900 10 560 2		12900 10 560 2		41,2	66,9
630	900 10 630 2		12900 10 630 2		46,3	84,6

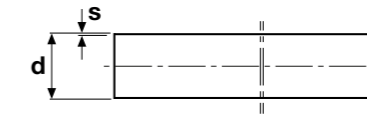
PE 100 Boru SDR 11 - PN16
 PE 100 Pipe SDR 11 - PN16

Çap Dia	Kod / Code 6 m	Fiyat (m) Price (m)	Kod / Code 12 m	Fiyat (m) Price (m)	s (mm) Et Kalınlığı Wall thickness	Kg / Mt
20	900 20 020 2		900 21 020		2,0	0,112
25	900 20 025 2		900 21 025		2,3	0,171
32	900 20 032 2		900 21 032		3,0	0,272
40	900 20 040 2		900 21 040		3,7	0,43
50	900 20 050 2		900 21 050		4,6	0,666
63	900 20 063 2		900 21 063		5,8	1,05
75	900 20 075 2		900 21 075		6,8	1,47
90	900 20 090 2		900 21 090		8,2	2,12
110	900 20 110 2		900 21 110		10,0	3,14
125	900 20 125 2		900 21 125		11,4	4,08
140	900 20 140 2		900 21 140		12,7	5,08
160	900 20 160 2		900 21 160		14,6	6,67
180	900 20 180 2		900 21 180		16,4	8,42
200	900 20 200 2		900 21 200		18,2	10,4
225	900 20 225 2		900 21 225		20,5	13,1
250	900 20 250 2		900 21 250		22,7	16,2
280	900 20 280 2		900 21 280		25,4	20,3
315	900 20 315 2		900 21 315		28,6	25,6
355	900 20 355 2		900 21 355		32,2	32,5
400	900 20 400 2		900 21 400		36,3	41,3
450	900 20 450 2		900 21 450		40,9	52,3
500	900 20 500 2		900 21 500		45,4	64,5
560	900 20 560 2		900 21 560		50,8	80,8
630	900 20 630 2		900 21 630		57,2	102

PE 100 Boru SDR 9 - PN20
 PE 100 Pipe SDR 9 - PN20

Çap Dia	Kod / Code 6 m	Fiyat (m) Price (m)	Kod / Code 12 m	Fiyat (m) Price (m)	s (mm) Et Kalınlığı Wall thickness	Kg / Mt
20	900 09 020 2		12900 09 020 2		2,3	0,133
25	900 09 025 2		12900 09 025 2		3,0	0,22
32	900 09 032 2		12900 09 032 2		3,6	0,327
40	900 09 040 2		12900 09 040 2		4,5	0,509
50	900 09 050 2		12900 09 050 2		5,6	0,788
63	900 09 063 2		12900 09 063 2		7,1	1,26
75	900 09 075 2		12900 09 075 2		8,4	1,76
90	900 09 090 2		12900 09 090 2		10,1	2,54
110	900 09 110 2		12900 09 110 2		12,3	3,78
125	900 09 125 2		12900 09 125 2		14,0	4,87
140	900 10 140 2		12900 10 140 2		15,7	6,11
160	900 10 160 2		12900 10 160 2		17,9	7,96
180	900 10 180 2		12900 10 180 2		20,1	10,1
200	900 10 200 2		12900 10 200 2		22,4	12,4
225	900 09 225 2		12900 09 225 2		25,2	15,8
250	900 09 250 2		12900 09 250 2		27,9	19,4
280	900 09 280 2		12900 09 280 2		31,3	24,3
315	900 09 315 2		12900 09 315 2		35,2	30,8
355	900 09 355 2		12900 09 355 2		39,7	39,1
400	900 09 400 2		12900 09 400 2		44,7	49,6
450	900 09 450 2		12900 09 450 2		50,3	62,7
500	900 09 500 2		12900 09 500 2		55,8	77,3
560	900 09 560 2		12900 09 560 2		62,5	97
630	900 09 630 2		12900 09 630 2		70,3	125

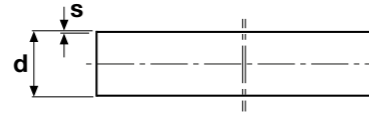
PE 100 Boru SDR 7,4 - PN25
 PE 100 Pipe SDR 7,4 - PN25

Çap Dia	Kod / Code 6 m	Fiyat (m) Price (m)	Kod / Code 12 m	Fiyat (m) Price (m)	s (mm) Et Kalınlığı Wall thickness	Kg / Mt
20	900 25 020 2		12900 25 020 2		3,0	0,15
25	900 25 025 2		12900 25 025 2		3,5	0,24
32	900 25 032 2		12900 25 032 2		4,4	0,38
40	900 25 040 2		12900 25 040 2		5,5	0,60
50	900 25 050 2		12900 25 050 2		6,9	0,93
63	900 25 063 2		12900 25 063 2		8,6	1,47
75	900 25 075 2		12900 25 075 2		10,3	2,09
90	900 25 090 2		12900 25 090 2		12,3	3,00
110	900 25 110 2		12900 25 110 2		15,1	4,49
125	900 25 125 2		12900 25 125 2		17,1	5,77
140	900 25 140 2		12900 25 140 2		19,2	7,25
160	900 25 160 2		12900 25 160 2		21,9	9,44
180	900 25 180 2		12900 25 180 2		24,6	11,9
200	900 25 200 2		12900 25 200 2		27,4	14,8
225	900 25 225 2		12900 25 225 2		30,8	18,6
250	900 25 250 2		12900 25 250 2		34,2	23,0
280	900 25 280 2		12900 25 280 2		38,3	28,9
315	900 25 315 2		12900 25 315 2		43,1	36,5
355	900 25 355 2		12900 25 355 2		48,5	46,3
400	900 25 400 2		12900 25 400 2		54,7	58,8
450	900 25 450 2		12900 25 450 2		61,5	74,4
500	900 25 500 2		12900 25 500 2		68,3	91,8

PE 100 Boru SDR 6 - PN32
 PE 100 Pipe SDR 6 - PN32

Çap Dia	Kod / Code 6 m	Fiyat (m) Price (m)	Kod / Code 12 m	Fiyat (m) Price (m)	s (mm) Et Kalınlığı Wall thickness	Kg / Mt
20	900 10 020 1		12900 10 020 1		3,4	0,18
25	900 10 025 1		12900 10 025 1		4,2	0,27
32	900 10 032 1		12900 10 032 1		5,4	0,45
40	900 10 040 1		12900 10 040 1		6,7	0,70
50	900 10 050 1		12900 10 050 1		8,3	1,09
63	900 10 063 1		12900 10 063 1		10,5	1,73
75	900 10 075 1		12900 10 075 1		12,5	2,44
90	900 10 090 1		12900 10 090 1		15,0	3,51
110	900 10 110 1		12900 10 110 1		18,3	5,24
125	900 10 125 1		12900 10 125 1		20,8	6,75
140	900 10 140 1		12900 10 140 1		23,3	8,47
160	900 10 160 1		12900 10 160 1		26,6	11,0
180	900 10 180 1		12900 10 180 1		29,9	14,0
200	900 10 200 1		12900 10 200 1		33,2	17,2
225	900 10 225 1		12900 10 225 1		37,4	21,8
250	900 10 250 1		12900 10 250 1		41,5	27,0
280	900 10 280 1		12900 10 280 1		46,5	33,8
315	900 10 315 1		12900 10 315 1		52,3	42,7
355	900 10 355 1		12900 10 355 1		59,0	54,3
400	900 10 400 1		12900 10 400 1		66,5	68,9

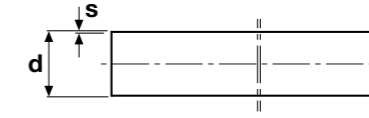
PE 100 Kangal Boru SDR 41 - PN4
 PE 100 Pipe SDR 41 - PN4

Çap Dia	Kod Code	Fiyat (m) Price (m)	s (mm) Et Kalınlığı Wall thickness	Kg / Mt
90	950 04 090		2,3	0,643
110	950 04 110		2,7	0,943

PE 100 Kangal Boru SDR 33 - PN5
 PE 100 Coil Pipe SDR 33 - PN5

Çap Dia	Kod Code	Fiyat (m) Price (m)	s (mm) Et Kalınlığı Wall thickness	Kg / Mt
63	950 05 063		2,0	0,399
75	950 05 075		2,3	0,551
90	950 05 090		2,8	0,791
110	950 05 110		3,4	1,17

PE 100 Kangal Boru SDR 26 - PN6
 PE 100 Coil Pipe SDR 26 - PN6

Çap Dia	Kod Code	Fiyat (m) Price (m)	s (mm) Et Kalınlığı Wall thickness	Kg / Mt
50	950 06 050		2,0	0,314
63	950 06 063		2,5	0,494
75	950 06 075		2,9	0,675
90	950 06 090		3,5	0,978
110	950 06 110		4,2	1,43

PE 100 Kangal Boru SDR 21 - PN8
 PE 100 Coil Pipe SDR 21 - PN8

Çap Dia	Kod Code	Fiyat (m) Price (m)	s (mm) Et Kalınlığı Wall thickness	Kg / Mt
40	950 08 040		2	0,239
50	950 08 050		2,4	0,359
63	950 08 063		3	0,565
75	950 08 075		3,6	0,807
90	950 08 090		4,3	1,16
110	950 08 110		5,3	1,74

PE 100 Kangal Boru SDR 17 - PN10
 PE 100 Coil Pipe SDR 17 - PN10

Çap Dia	Kod Code	Fiyat (m) Price (m)	s (mm) Et Kalınlığı Wall thickness	Kg / Mt
32	950 00 032		2	0,187
40	950 00 040		2,4	0,295
50	950 00 050		3	0,453
63	950 00 063		3,8	0,721
75	950 00 075		4,5	1,02
90	950 00 090		5,4	1,46
110	950 00 110		6,6	2,17

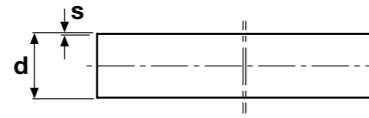
**PE 100 Kangal Boru SDR 13,6 - PN12,5**

PE 100 Coil Pipe SDR 13,6 - PN12,5

Çap Dia	Kod Code	Fiyat (m) Price (m)	s (mm) Et Kalınlığı Wall thickness	Kg / Mt	Kangal 100 m
25	950 12 025		2	0,152	
32	950 12 032		2,4	0,232	
40	950 12 040		3	0,356	
50	950 12 050		3,7	0,549	
63	950 12 063		4,7	0,873	
75	950 12 075		5,6	1,24	
90	950 12 090		6,7	1,77	
110	950 12 110		8,1	2,62	

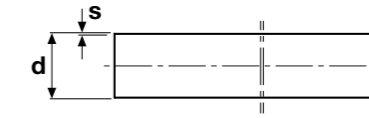
**PE 100 Kangal Boru SDR 7,4 - PN25**

PE 100 Coil Pipe SDR 7,4 - PN25

Çap Dia	Kod Code	Fiyat (m) Price (m)	s (mm) Et Kalınlığı Wall thickness	Kg / Mt	Kangal 100 m
20	950 25 020		3	0,154	
25	950 25 025		3,5	0,24	
32	950 25 032		4,4	0,386	
40	950 25 040		5,5	0,6	
50	950 25 050		6,9	0,936	
63	950 25 063		8,6	1,47	
75	950 25 075		10,3	2,09	
90	950 25 090		12,3	3	
110	950 25 110		15,1	4,49	

PE 100 Kangal Boru SDR 11 - PN16

PE 100 Coil Pipe SDR 11 - PN16

Çap Dia	Kod Code	Fiyat (m) Price (m)	s (mm) Et Kalınlığı Wall thickness	Kg / Mt	Kangal 100 m
20	950 20 020		2	0,112	
25	950 20 025		2,3	0,171	
32	950 20 032		3	0,272	
40	950 20 040		3,7	0,43	
50	950 20 050		4,6	0,666	
63	950 20 063		5,8	1,05	
75	950 20 075		6,8	1,47	
90	950 20 090		8,2	2,12	
110	950 20 110		10	3,14	

PE 100 Kangal Boru SDR 6 - PN32

PE 100 Coil Pipe SDR 6 - PN32

Çap Dia	Kod Code	Fiyat (m) Price (m)	s (mm) Et Kalınlığı Wall thickness	Kg / Mt	Kangal 100 m
20	950 32 020		3,4	0,18	
25	950 32 025		4,2	0,278	
32	950 32 032		5,4	0,454	
40	950 32 040		6,7	0,701	
50	950 32 050		8,3	1,09	
63	950 32 063		10,5	1,73	
75	950 32 075		12,5	2,44	
90	950 32 090		15	3,51	
110	950 32 110		18,3	5,24	

PE 100 Kangal Boru SDR 9 - PN20

PE 100 Coil Pipe SDR 9 - PN20

Çap Dia	Kod Code	Fiyat (m) Price (m)	s (mm) Et Kalınlığı Wall thickness	Kg / Mt	Kangal 100 m
20	950 30 020		2,3	0,133	
25	950 30 025		3	0,22	
32	950 30 032		3,6	0,327	
40	950 30 040		4,5	0,509	
50	950 30 050		5,6	0,788	
63	950 30 063		7,1	1,26	
75	950 30 075		8,4	1,76	
90	950 30 090		10,1	2,54	
110	950 30 110		12,3	3,78	

Not / Note

HDPE

VANA

VALVE

ÜRETİM STANDARDI

PRODUCTION STANDARD

TS EN 12201-4

ÇAP / SIZE Ø20 - Ø400



U-PVC Kelebek Vana (Takım) HDPE Çıkışlı PP Kaplı Çelik Flanşlı
U-PVC Butterfly Valve Set HDPE Soketed PP Coated S.S. Flange

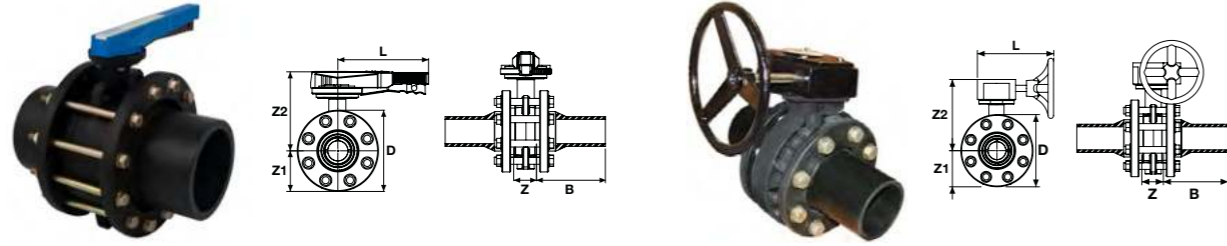

Ø63-225

Ø250-280

Çap Dia	Basınç PN	Kod Code	Fiyat (Adet) Price (Pcs)	Kg /Adet Kg/Pcs	Koli/Ad. Box/Pcs	DN (mm)	D (mm)	Z (mm)	Z1 (mm)	Z2 (mm)	B (mm)	L (mm)	nØe (mm)	ISO 5211 ISO 5211	kv-value l/min.
63	10	200 60 063 2		3,00	4	50	165	51	82	188	100	207	4 x 19	F 07	1470
75	10	200 60 075 2		5,00	4	65	185	52	92	180	120	207	4 x 19	F 07	2200
90	10	200 60 090 2		6,60	4	80	200	58	100	183	125	207	8 x 19	F 07	3000
110	10	200 60 110 2		6,60	2	100	220	66	110	208	128	258	8 x 19	F 07	6500
125	10	200 60 125 2		9,50	2	110	250	73	125	221	138	258	8 x 23	F 07	11500
140	10	200 60 140 2		9,90	2	125	250	73	125	221	145	258	8 x 23	F 07	11500
160	10	200 60 160 2		11,4	2	150	285	76	142	235	160	258	8 x 24	F 07	16600
200	10	200 60 200 2		17,1	1	175	340	87	170	255	175	335	8 x 24	F 07	39600
225	10	200 60 225 2		36,7	1	200	340	87	170	255	196	335	8 x 24	F 07	39600
*250	10	200 60 250 2		36,7	1	250	395	123	198	309	205	410	8 x 24	F 10	55200
*280	10	200 60 280 2		39,2	1	250	395	119	198	309	215	410	12 x 24	F 10	55200
*315	10	200 60 315 2		44,5	1	300	445	121	228	370	220	410	12 x 24	F 10	80000
*355	6	200 60 355 2			1	350	505	140	255	372		410	16 x 24	F 12	90000
*400	6	200 60 400 2			1	400	565	169	285	402	259	410	16 x 26	F 12	115000

U-PVC Kelebek Vana (Takım) HDPE Çıkışlı PP Kaplı Çelik Flanşlı (316 Paslanmaz Civata-Somun)
U-PVC Butterfly Valve Set HDPE Soketed S.S. 316 Flange (316 Washer-Nut)

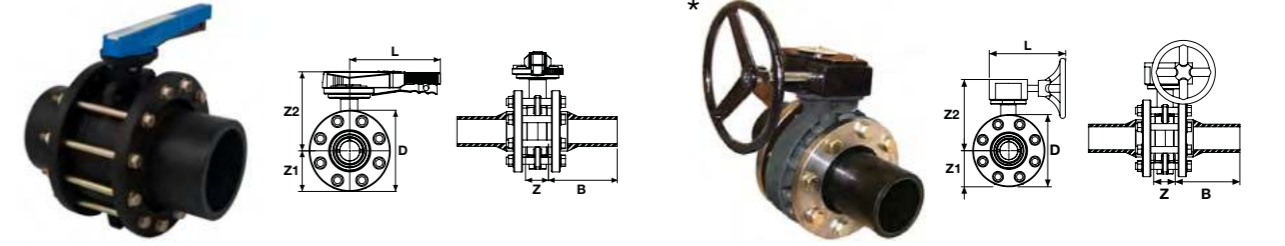

Ø63-225

Ø250-280

Çap Dia	Basınç PN	Kod Code	Fiyat (Adet) Price (Pcs)	Kg /Adet Kg/Pcs	Koli/Ad. Box/Pcs	DN (mm)	D (mm)	Z (mm)	Z1 (mm)	Z2 (mm)	B (mm)	L (mm)	nØe (mm)	ISO 5211 ISO 5211	kv-value l/min.
63	10	200 40 063 2		3,00	4	50	165	51	82	188	100	207	4 x 19	F 07	1470
75	10	200 40 075 2		5,00	4	65	185	52	92	180	120	207	4 x 19	F 07	2200
90	10	200 40 090 2		6,60	4	80	200	58	100	183	125	207	8 x 19	F 07	3000
110	10	200 40 110 2		6,60	2	100	220	66	110	208	128	258	8 x 19	F 07	6500
125	10	200 40 125 2		9,50	2	110	250	73	125	221	138	258	8 x 23	F 07	11500
140	10	200 40 140 2		9,90	2	125	250	73	125	221	145	258	8 x 23	F 07	11500
160	10	200 40 160 2		11,4	2	150	285	76	142	235	160	258	8 x 24	F 07	16600
200	10	200 40 200 2		17,1	1	175	340	87	170	255	175	335	8 x 24	F 07	39600
225	10	200 40 225 2		36,7	1	200	340	87	170	255	196	335	8 x 24	F 07	39600
*250	10	200 40 250 2		36,7	1	250	395	123	198	309	205	410	8 x 24	F 10	55200
*280	10	200 40 280 2		39,2	1	250	395	119	198	309	215	410	12 x 24	F 10	55200
*315	10	200 40 315 2		44,5	1	300	445	121	228	370	220	410	12 x 24	F 10	80000
*355	6	200 40 355 2			1	350	505	140	255	372		410	16 x 24	F 12	90000
*400	6	200 40 400 2			1	400	565	169	285	402	259	410	16 x 26	F 12	115000

U-PVC Kelebek Vana (Takım) HDPE Çıkışlı PP Kaplı Çelik Flanşlı (304 Paslanmaz Civata-Somun)
U-PVC Butterfly Valve Set HDPE Soketed S.S. 304 Flange (304 Washer-Nut)

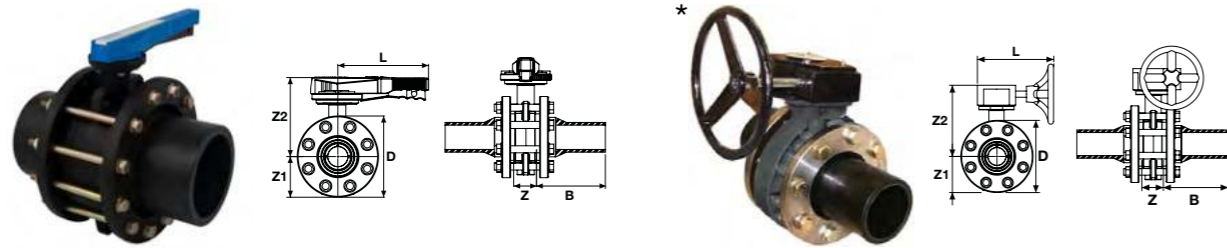

Ø63-225

Ø250-280

Çap Dia	Basınç PN	Kod Code	Fiyat (Adet) Price (Pcs)	Kg /Adet Kg/Pcs	Koli/Ad. Box/Pcs	DN (mm)	D (mm)	Z (mm)	Z1 (mm)	Z2 (mm)	B (mm)	L (mm)	nØe (mm)	ISO 5211 ISO 5211	kv-value l/min.
63	10	200 20 063 2		3,00	4	50	165	51	82	188	100	207	4 x 19	F 07	1470
75	10	200 20 075 2		5,00	4	65	185	52	92	180	120	207	4 x 19	F 07	2200
90	10	200 20 090 2		6,60	4	80	200	58	100	183	125	207	8 x 19	F 07	3000
110	10	200 20 110 2		6,60	2	100	220	66	110	208	128	258	8 x 19	F 07	6500
125	10	200 20 125 2		9,50	2	110	250	73	125	221	138	258	8 x 23	F 07	11500
140	10	200 20 140 2		9,90	2	125	250	73	125	221	145	258	8 x 23	F 07	11500
160	10	200 20 160 2		11,4	2	150	285	76	142	235	160	258	8 x 24	F 07	16600
200	10	200 20 200 2		17,1	1	175	340	87	170	255	175	335	8 x 24	F 07	39600
225	10	200 20 225 2		36,7	1	200	340	87	170	255	196	335	8 x 24	F 07	39600
*250	10	200 20 250 2		36,7	1	250	395	123	198	309	205	410	8 x 24	F 10	55200
*280	10	200 20 280 2		39,2	1	250	395	119	198	309	215	410	12 x 24	F 10	55200
*315	10	200 20 315 2		44,5	1	300	445	121	228	370	220	410	12 x 24	F 10	80000
*355	6	200 20 355 2			1	350	505	140	255	372		410	16 x 24	F 12	90000
*400	6	200 20 400 2			1	400	565	169	285	402	259	410	16 x 26	F 12	115000

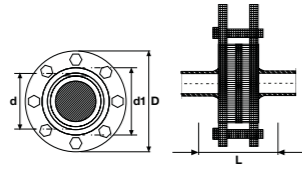
U-PVC Çalpara Çekvalf (Takım) HDPE Çıkışlı PP Kaplı Çelik Flanşlı
 U-PVC Wafer Cekvalve Set HDPE Soketed PP Coated With S.S. Flange

Çap Dia	Basınç PN	Kod Code	Fiyat (Adet) Price (Pcs)	Kg /Adet Kg/Pcs	Koli/Adet Box/Pcs	DN (mm)	D1 (mm)	D (mm)	L (mm)	nQe (mm)
63	16	221 60 063 2			4	50	78	165	216	4 x 16
75	16	221 60 075 2			4	65	92	185	256	4 x16
90	16	221 60 090 2			4	80	108	204	266	8 x 16
110	16	221 60 110 2			2	100	128	224	275	8 x 16
125	16	221 60 125 2			2	100	150	224	297	8 x 16
140	16	221 60 140 2			2	125	158	252	311	8 x 16
160	16	221 60 160 2			2	150	178	285	343	8 x 20
200	16	221 60 200 2			1	200	235	340	377	12 x 20
225	16	221 60 225 2			1	200	238	340	419	12 x 20

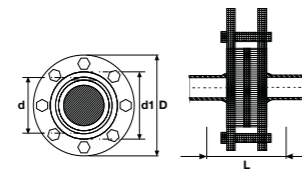
U-PVC Çalpara Çekvalf (Takım) HDPE Çıkışlı Çelik (304) Flanşlı
 U-PVC Water Cekvalve HDPE Soketed PP Coated With S.S. 304 Flange (304 Washer-Nut)

Çap Dia	Basınç PN	Kod Code	Fiyat (Adet) Price (Pcs)	Kg /Adet Kg/Pcs	Koli/Adet Box/Pcs	DN (mm)	D1 (mm)	D (mm)	L (mm)	nQe (mm)
63	16	221 40 063 2			4	50	78	165	216	4 x 16
75	16	221 40 075 2			4	65	92	185	256	4 x16
90	16	221 40 090 2			4	80	108	204	266	8 x 16
110	16	221 40 110 2			2	100	128	224	275	8 x 16
125	16	221 40 125 2			2	100	150	224	297	8 x 16
140	16	221 40 140 2			2	125	158	252	311	8 x 16
160	16	221 40 160 2			2	150	178	285	343	8 x 20
200	16	221 40 200 2			1	200	235	340	377	12 x 20
225	16	221 40 225 2			1	200	238	340	419	12 x 20

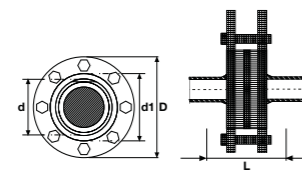
U-PVC Çalpara Çekvalf (Takım) HDPE Çıkışlı Çelik (316) Flanşlı
 U-PVC Water Cekvalve HDPE Soketed PP Coated With S.S. 316 Flange (316 Washer-Nut)

Çap Dia	Basınç PN	Kod Code	Fiyat (Adet) Price (Pcs)	Kg /Adet Kg/Pcs	Koli/Adet Box/Pcs	DN (mm)	D1 (mm)	D (mm)	L (mm)	nQe (mm)
63	16	221 20 063 2			4	50	78	165	216	4 x 16
75	16	221 20 075 2			4	65	92	185	256	4 x16
90	16	221 20 090 2			4	80	108	204	266	8 x 16
110	16	221 20 110 2			2	100	128	224	275	8 x 16
125	16	221 20 125 2			2	100	150	224	297	8 x 16
140	16	221 20 140 2			2	125	158	252	311	8 x 16
160	16	221 20 160 2			2	150	178	285	343	8 x 20
200	16	221 20 200 2			1	200	235	340	377	12 x 20
225	16	221 20 225 2			1	200	238	340	419	12 x 20

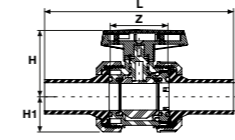
U-PVC Küresel Su Vanası HDPE Çıkışlı
 U-PVC True Union Ball Valve For Water With HDPE Socketed

Çap Dia	Basınç PN	Kod Code	Fiyat (Adet) Price (Pcs)	Kg /Adet Kg/Pcs	Koli/Adet Box/Pcs	DN (mm)	kv l/min	Z (mm)	L1 (mm)	L (mm)	H (mm)	H1 (mm)
20	16	202 20 020 2			64	15	185	52	45	205	47	27
25	16	202 20 025 2			56	20	350	58	49	211	51	31
32	16	202 20 032 2			36	25	700	61	54	224	63	33
40	16	202 20 040 2			30	32	1000	73	66	242	67	42
50	16	202 20 050 2			20	40	1600	82	75	259	86	46
63	16	202 20 063 2			20	50	3100	95	89	289	101	58
75	16	202 20 075 2			8	65	5000	118	111	356	110	64
90	16	202 20 090 2			4	80	7000	139	126	390	137	90
110	16	202 20 110 2			2	100	11000	165	153	453	150	106

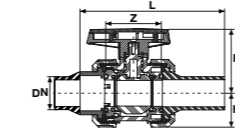
U-PVC Küresel Su Vanası Tek Taraf HDPE Çıkışlı Tek Taraf İç Dişli
 U-PVC True Union Ball Valve For Water One Side HDPE Socketed One Side Female Threaded

Çap Dia	Rp (Inch)	Basınç PN	Kod Code	Fiyat (Adet) Price (Pcs)	Kg /Adet Kg/Pcs	Koli/Adet Box/Pcs	DN (mm)	kv l/min	Z (mm)	L (mm)	H (mm)	H1 (mm)
20	1/2"	16	202 40 020 2			64	15	185	52	127	47	27
25	3/4"	16	202 40 025 2			56	20	350	58	136	51	31
32	1"	16	202 40 032 2			36	25	700	61	152	63	33
40	1 1/4"	16	202 40 040 2			30	32	1000	73	176	67	42
50	1 1/2"	16	202 40 050 2			20	40	1600	82	207	86	46
63	2"	16	202 40 063 2			20	50	3100	95	234	101	58
75	2 1/2"	16	202 40 075 2			8	65	5000	118	265	110	64
90	3"	16	202 40 090 2			4	80	7000	139	320	137	90
110	4"	16	202 40 110 2			2	100	11000	165	372	150	106

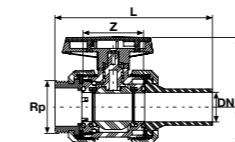
U-PVC Küresel Su Vanası Tek Taraf HDPE Çıkışlı Tek Taraf Piriç Dış Dişli
 U-PVC True Union Ball Valve For Water One Side HDPE Socketed One Side Brass Male Threaded

Çap Dia	Rp (Inch)	Basınç PN	Kod Code	Fiyat (Adet) Price (Pcs)	Kg /Adet Kg/Pcs	Koli/Adet Box/Pcs	DN (mm)	kv l/min	Z (mm)	L (mm)	H (mm)	H1 (mm)
20	1/2"	16	202 60 020 2			64	15	185	52	127	47	27
25	3/4"	16	202 60 025 2			56	20	350	58	136	51	31
32	1"	16	202 60 032 2			36	25	700	61	152	63	33
40	1 1/4"	16	202 60 040 2			30	32	1000	73	176	67	42
50	1 1/2"	16	202 60 050 2			20	40	1600	82	207	86	46
63	2"	16	202 60 063 2			20	50	3100	95	234	101	58

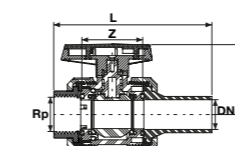
U-PVC Küresel Su Vanası Tek Taraf HDPE Çıkışlı Tek Taraf Piriç İç Dişli
 U-PVC True Union Ball Valve For Water One Side HDPE Socketed One Side Brass Female Threaded

Çap Dia	Rp (Inch)	Basınç PN	Kod Code	Fiyat (Adet) Price (Pcs)	Kg /Adet Kg/Pcs	Koli/Adet Box/Pcs	DN (mm)	kv l/min	Z (mm)	L (mm)	H (mm)	H1 (mm)
20	1/2"	16	202 70 020 2			64	15	185	52	127	47	27
25	3/4"	16	202 70 025 2			56	20	350	58	136	51	31
32	1"	16	202 70 032 2			36	25	700	61	152	63	33
40	1 1/4"	16	202 70 040 2			30	32	1000	73	176	67	42
50	1 1/2"	16	202 70 050 2			20	40	1600	82	207	86	46
63	2"	16	202 70 063 2			20	50	3100	95	234	101	58

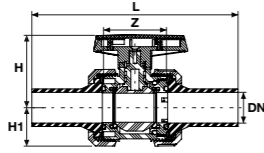
U-PVC Küresel Su Vanası Çift Taraf HDPE Spigot Çıkışlı
 U-PVC True Union Ball Valve For Water Both Sides HDPE Spigot Outlet

Çap Dia	Basınç PN	EPDM Conta Kod EPDM O-Ring Code	Fiyat (Adet) Price (Pcs)	Kg/Adet Kg/Pcs	Koli/Adet Box/Pcs	DN (mm)	Z mm)	L1 (mm)	L (mm)	H (mm)	H1 (mm)	kv l/min
20	16	233 011 020 2			64	15	52	45	205	47	27	185
25	16	233 011 025 2			56	20	58	49	211	51	31	350
32	16	233 011 032 2			36	25	61	54	224	63	33	700
40	16	233 011 040 2			30	32	73	66	242	67	42	1000
50	16	233 011 050 2			20	40	82	75	259	86	46	1600
63	16	233 011 063 2			20	50	95	89	289	101	58	3100
75	16	233 011 075 2			8	65	118	111	356	110	64	5000
90	16	233 011 090 2			4	80	139	126	390	137	90	7000
110	16	233 011 110 2			2	100	165	153	453	150	106	11000

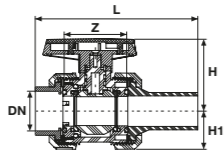
U-PVC Küresel Su Vanası Tek Taraf HDPE Spigot Çıkışlı
 U-PVC True Union Ball Valve For Water One Side HDPE Spigot Outlet

Çap Dia	Basınç PN	EPDM Conta Kod EPDM O-Ring Code	Fiyat (Adet) Price (Pcs)	Kg/Adet Kg/Pcs	Koli/Adet Box/Pcs	DN (mm)	Z mm)	L (mm)	H (mm)	H1 (mm)	kv l/min
20	16	233 012 020 2			64	15	52	127	47	27	185
25	16	233 012 025 2			56	20	58	136	51	31	350
32	16	233 012 032 2			36	25	61	152	63	33	700
40	16	233 012 040 2			30	32	73	176	67	42	1000
50	16	233 012 050 2			20	40	82	207	86	46	1600
63	16	233 012 063 2			20	50	95	234	101	58	3100
75	16	233 012 075 2			8	65	118	265	110	64	5000
90	16	233 012 090 2			4	80	139	320	137	90	7000
110	16	233 012 110 2			2	100	165	372	150	106	11000

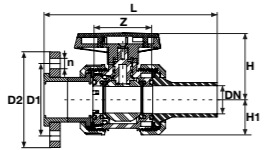
U-PVC Küresel Su Vanası Tek Taraf Flanş Bağlantılı Tek Taraf HDPE Spigot Çıkışlı
 U-PVC One Side Flange Adaptor One Side HDPE Spigot True Union Ball Valve

Çap Dia	Basınç PN	EPDM Conta Kod EPDM O-Ring Code	Fiyat (Adet) Price (Pcs)	Kg/Adet Kg/Pcs	Koli/Adet Box/Pcs	DN (mm)	Z mm)	L (mm)	H (mm)	H1 (mm)	D1 (mm)	D2 (mm)	kv l/min	n (mm)
20	16	233 015 020 2			64	15	52	146	47	27	65	96	185	14x4
25	16	233 015 025 2			56	20	58	158	51	31	75	105	350	14x4
32	16	233 015 032 2			36	25	61	177	63	33	85	115	700	14x4
40	16	233 015 040 2			30	32	73	205	67	42	100	140	1000	14x4
50	16	233 015 050 2			20	40	82	241	86	46	100	150	1600	18x4
63	16	233 015 063 2			20	50	95	275	101	58	125	165	3100	18x4
75	16	233 015 075 2			8	65	118	312	110	64	145	185	5000	22x4
90	16	233 012 090 2			4	80	139	376	137	90	160	200	7000	22x8
110	16	233 012 110 2			2	100	165	438	150	106	180	220	11000	24x8

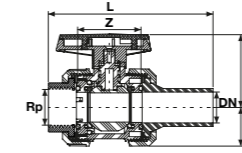
U-PVC Küresel Su Vanası Tek Taraf Pirinç İç Dişli Tek Taraf HDPE Spigot Çıkışlı
 U-PVC True Union Ball Valve For Water One Side Brass Female Threaded One Side HDPE Spigot Outlet

Çap Dia	Rp (Inch)	Basınç PN	EPDM Conta Kod EPDM O-Ring Code	Fiyat (Adet) Price (Pcs)	Kg/Adet Kg/Pcs	Koli/Adet Box/Pcs	DN (mm)	Z mm)	L (mm)	H (mm)	H1 (mm)	kv l/min
20	1/2"	16	233 013 020 2			64	15	52	127	47	27	185
25	3/4"	16	233 013 025 2			56	20	58	136	51	31	350
32	1"	16	233 013 032 2			36	25	61	152	63	33	700
40	1 1/4"	16	233 013 040 2			30	32	73	176	67	42	1000
50	1 1/2"	16	233 013 050 2			20	40	82	207	86	46	1600
63	2"	16	233 013 063 2			20	50	95	234	101	58	3100
75	2 1/2"	16	233 013 075 2			8	65	118	265	110	64	5000
90	3"	16	233 013 090 2			4	80	139	320	137	90	7000
110	4"	16	233 013 110 2			2	100	165	372	150	106	11000

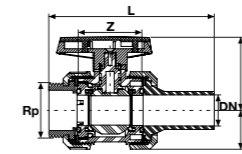
U-PVC Küresel Su Vanası Tek Taraf Pirinç Dış Dişli Tek Taraf HDPE Spigot Çıkışlı
 U-PVC True Union Ball Valve One Side Brass Male Threaded One Side HDPE Spigot Outlet

Çap Dia	Rp (Inch)	Basınç PN	EPDM Conta Kod EPDM O-Ring Code	Fiyat (Adet) Price (Pcs)	Kg/Adet Kg/Pcs	Koli/Adet Box/Pcs	DN (mm)	Z mm)	L (mm)	H (mm)	H1 (mm)	kv l/min
20	1/2"	16	233 014 020 2			64	15	52	127	47	27	185
25	3/4"	16	233 014 025 2			56	20	58	136	51	31	350
32	1"	16	233 014 032 2			36	25	61	152	63	33	700
40	1 1/4"	16	233 014 040 2			30	32	73	176	67	42	1000
50	1 1/2"	16	233 014 050 2			20	40	82	207	86	46	1600
63	2"	16	233 014 063 2			20	50	95	234	101	58	3100
75	2 1/2"	16	233 014 075 2			8	65	118	265	110	64	5000
90	3"	16	233 014 090 2			4	80	139	320	137	90	7000
110	4"	16	233 014 110 2			2	100	165	372	150	106	11000

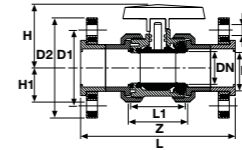
U-PVC Küresel Su Vanası PP Kaplı Çelik Flanş Bağlantılı
 U-PVC True Union Ball Valve Both Side HDPE Flanged

Çap Dia	Basınç PN	EPDM Conta Kod EPDM O-Ring Code	Fiyat (Adet) Price (Pcs)	Kg/Adet Kg/Pcs	Koli/Adet Box/Pcs	DN (mm)	Z mm)	L (mm)	L1 (mm)	H (mm)	H1 (mm)	D1 (mm)	D2 (mm)	kv l/min	n (mm)
20	16	233 016 020 2		0,36	40	15	52	123	45	47	27	65	95	185	14 x 4
25	16	233 016 025 2		0,47	30	20	58	140	49	51	31	75	105	350	14 x 4
32	16	233 016 032 2		0,66	25	25	61	158	54	63	33	85	115	700	14 x 4
40	16	233 016 040 2		1,08	20	32	73	186	66	67	42	100	140	1000	18 x 4
50	16	233 016 050 2		1,44	10	40	82	231	75	86	46	110	150	1600	18 x 4
63	16	233 016 063 2		2,29	10	50	95	253	89	101	58	125	165	3100	18 x 4
75	16	233 016 075 2		2,99	4	65	118	291	111	110	73	145	185	5000	18 x 4
90	16	233 016 090 2		5,7	2	80	139	353	126	137	90	160	200	7000	18 x 8
110	16	233 016 110 2		8,05	1	100	165	431	153	150	106	180	220	11000	18 x 8

Not / Note

HDPE

EF EK PARÇALAR

EF FITTINGS

ÜRETİM STANDARDI

PRODUCTION STANDARD

TS EN 12201-3 +A1

ÇAP / SIZE Ø20 - Ø400



 **PIMTAŞ**[®]

Since 1977

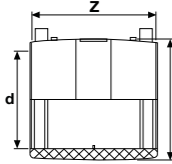
EF Manşon
 EF Double Socket

PE 100 SDR11

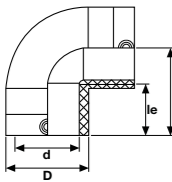
Çap Dia	Basınç PN	Kod Code	Fiyat (Adet) Price (Pcs)	Kg/Adet Kg/Pcs	Koli/Adet Box/Pcs	D (mm)	Z (mm)
20	16	902 004 020 2		0,033	80	29	77
25	16	902 004 032 2		0,037	80	34	77
32	16	902 004 040 2		0,057	75	43	77
40	16	902 004 050 2		0,080	90	52	90
50	16	902 004 063 2		0,096	70	62	91
63	16	902 004 075 2		0,164	18	80	98
75	16	902 004 090 2		0,221	16	94	110
90	16	902 004 110 2		0,378	12	111	124
110	16	902 004 125 2		0,652	15	136	144
125	16	902 004 125 2		0,769	16	151	154
140	16	902 004 140 2		0,944	12	169	162
160	16	902 004 160 2		1,327	10	193	172
180	16	902 004 180 2		1,907	8	217	184
200	16	902 004 200 2		2,445	4	241	198
225	16	902 004 225 2		3,269	4	271	212
250	16	902 004 250 2		4,391	2	304	228
280	16	902 004 280 2		6,080	1	340	244
315	16	902 004 315 2		7,940	1	380	264
355	16	902 004 355 2		10,330	1	433	280
400	16	902 004 400 2		14,320	1	488	300

EF 90° Dirsek
 EF 90° Elbow

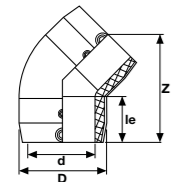
PE 100 SDR11

Çap Dia	Basınç PN	Kod Code	Fiyat (Adet) Price (Pcs)	Kg/Adet Kg/Pcs	Koli/Adet Box/Pcs	D (mm)	Z (mm)	le (mm)
20	16	902 006 020 2		0,150	40	43	63	40
25	16	902 006 025 2		0,060	100	35	60	41
32	16	902 006 032 2		0,100	80	44	62	40
40	16	902 006 040 2		0,120	55	52	65	42
50	16	902 006 050 2		0,170	50	63	72	45
63	16	902 006 063 2		0,310	25	81	84	50
75	16	902 006 075 2		0,440	16	95	92	53
90	16	902 006 090 2		0,680	15	113	109	60
110	16	902 006 110 2		1,150	6	137	135	73
125	16	902 006 125 2		1,640	6	154	152	78
160	16	902 006 160 2		5,000	2	201	205	87
180	16	902 006 180 2		4,120	2	222	197	90

EF 45° Dirsek
 EF 45° Elbow

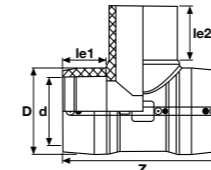
PE 100 SDR11

Çap Dia	Basınç PN	Kod Code	Fiyat (Adet) Price (Pcs)	Kg /Adet Kg/Pcs	Koli/Adet Box/Pcs	D (mm)	Z (mm)	le (mm)
32	16	902 005 032 2		0,080	100	44	99	40
40	16	902 005 040 2		0,100	70	53	108	42
50	16	902 005 050 2		0,130	50	63	124	45
63	16	902 005 063 2		0,230	30	79	137	50
75	16	902 005 075 2		0,350	20	94	153	53
90	16	902 005 090 2		0,550	18	117	177	60
110	16	902 005 110 2		0,930	10	137	213	75
125	16	902 005 125 2		1,250	6	154	240	79
160	16	902 005 160 2		4,500	2	201	283	89
180	16	902 005 180 2		3,130	2	222	299	90

EF Eşit Te
 EF Equal Tee

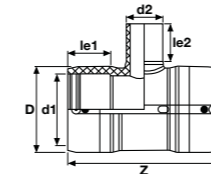
PE 100 SDR11

Çap Dia	Basınç PN	Kod Code	Fiyat (Adet) Price (Pcs)	Kg/Adet Kg/Pcs	Koli/Adet Box/Pcs	D (mm)	Z (mm)	le1 (mm)	le2 (mm)
20	16	902 007 020 2		0,140	50	44	98	35	65
25	16	902 007 025 2		0,130	50	44	98	35	65
32	16	902 007 032 2		0,110	50	44	98	35	65
40	16	902 007 040 2		0,160	18	52	131	44	59
50	16	902 007 050 2		0,190	25	64	138	43	55
63	16	902 007 063 2		0,360	20	82	164	49	63
75	16	902 007 075 2		0,550	14	95	189	55	70
90	16	902 007 090 2		0,820	16	112	210	65	79
110	16	902 007 110 2		1,450	6	139	260	72	82
125	16	902 007 125 2		2,240	4	160	268	77	87
160	16	902 007 160 2		3,340	2	195	320	86	98
180	16	902 007 180 2		5,300	2	230	340	88	105

EF İnegal Te
 EF Reducer Tee

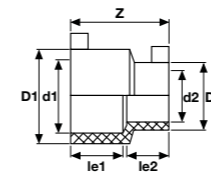
PE 100 SDR11

Çap Dia	Basınç PN	Kod Code	Fiyat (Adet) Price (Pcs)	Kg/Adet Kg/Pcs	Koli/Adet Box/Pcs	D (mm)	Z (mm)	le1 (mm)	le2 (mm)
50-40	16	902 08 5040 2		0,300	25	64	138	43	49
63-50	16	902 08 6350 2		0,330	18	82	164	49	55
63-40	16	902 08 6340 2		0,310	24	82	164	49	49
63-32	16	902 08 6332 2		0,300	24	82	164	49	44
75-63	16	902 08 7563 2		0,520	14	95	189	55	63
90-63	16	902 08 9063 2		0,740	8	112	210	65	63
110-90	16	902 08 11090 2		1,330	6	139	260	72	79
110-63	16	902 08 11063 2		1,220	8	139	260	72	63
125-110	16	902 08 125110 2		1,630	4	160	268	77	82
125-90	16	902 08 12590 2		1,550	4	160	268	77	79
125-63	16	902 08 12563 2		1,440	4	160	268	77	63
160-110	16	902 08 160110 2		2,890	2	195	320	86	82
160-90	16	902 08 16090 2		2,790	2	195	320	86	79
160-63	16	902 08 16063 2		2,700	2	195	320	86	63
180-125	16	902 08 180125 2		3,830	2	230	340	88	87

EF Redüksiyon
 EF Reducer

PE 100 SDR11

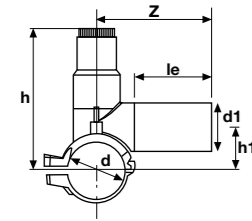
Çap Dia	Basınç PN	Kod Code	Fiyat (Adet) Price (Pcs)	Kg /Adet Kg/Pcs	Koli/Adet Box/Pcs	D1 (mm)	D2 (mm)	le1 (mm)	le2 (mm)	Z (mm)
25-20	16	902 09 2520 2		0,03	75	34	29	38	36	77
32-25	16	902 09 3225 2		0,05	75	43	34	39	37	77
32-20	16	902 09 3220 2		0,04	75	43	29	40	36	77
40-32	16	902 09 4032 2		0,10	100	52	43	46	43	84
50-40	16	902 09 5040 2		0,09	80	62	52	46	42	91
50-32	16	902 09 5032 2		0,08	80	62	44	46	40	91
63-50	16	902 09 6350 2		0,13	60	78	62	52	48	102
63-40	16	902 09 6340 2		0,10	60	77	52	52	45	102
63-32	16	902 09 6332 2		0,13	60	78	44	52	44	102
75-63	16	902 09 7563 2								
90-63	16	902 09 9063 2		0,30	35	110	79	62	55	123
110-90	16	902 09 11090 2		0,53	20	134	111	71	63	138
110-63	16	902 09 11063 2		0,54		135	80	71	53	158
125-90	16	902 09 12590 2		0,70	12	152	112	75	62	145
160-110	16	902 09 160110 2								
160-90	16	902 09 16090 2								
180-125	16	902 09 180125 2		2,09	4	216	157	115	90	221

EF Vanalı Servis Te
 EF Valve With Tee Servic

PE 100 SDR11

Çap Dia	Basınç PN	Kod Code	Fiyat (Adet) Price (Pcs)	Kg /Adet Kg/Pcs	Koli/Adet Box/Pcs	le (mm)	H (mm)	H1 (mm)	Z (mm)
63-63	16	903 001 063 063		2,360	6	100	223	114	152
63-50	16	903 001 063 050		2,330	6	74	223	114	126
63-40	16	903 001 063 040		2,320	6	74	223	114	126
63-32	16	903 001 063 032		2,300	6	74	223	114	126
63-25	16	903 001 063 025		2,280	6	74	223	114	126
63-20	16	903 001 063 020		2,270	6	74	223	114	126
75-63	16	903 001 075 063		2,490	6	100	229	120	152
75-50	16	903 001 075 050		2,460	6	74	229	120	126
75-40	16	903 001 075 040		2,450	6	74	229	120	126
75-32	16	903 001 075 032		2,430	6	74	229	120	126
75-25	16	903 001 075 025		2,410	6	74	229	120	126
75-20	16	903 001 075 020		2,400	6	74	229	120	126
90-63	16	903 001 090 063		2,450	6	100	237	128	152
90-50	16	903 001 090 050		2,420	6	74	237	128	126
90-40	16	903 001 090 040		2,410	6	74	237	128	126
90-32	16	903 001 090 032		2,390	6	74	237	128	126
90-25	16	903 001 090 025		2,370	6	74	237	128	126
90-20	16	903 001 090 020		2,360	6	74	237	128	126
110-63	16	903 001 110 063		2,510	6	100	247	138	152
110-50	16	903 001 110 050		2,480	6	74	247	138	126
110-40	16	903 001 110 040		2,470	6	74	247	138	126
110-32	16	903 001 110 032		2,450	6	74	247	138	126
110-25	16	903 001 110 025		2,430	6	74	247	138	126
110-20	16	903 001 110 020		2,420	6	74	247	138	126
125-63	16	903 001 125 063		2,540	6	100	254	145	152
125-50	16	903 001 125 050		2,510	6	74	254	145	126
125-40	16	903 001 125 040		2,500	6	74	254	145	126
125-32	16	903 001 125 032		2,480	6	74	254	145	126
125-25	16	903 001 125 025		2,460	6	74	254	145	126
125-20	16	903 001 125 020		2,520	6	74	254	145	126
140-63	16	903 001 140 063		2,540	5	100	262	153	152
140-50	16	903 001 140 050		2,510	5	74	262	153	126
140-40	16	903 001 140 040		2,500	5	74	262	153	126
140-32	16	903 001 140 032		2,480	5	74	262	153	126
140-25	16	903 001 140 025		2,460	5	74	262	153	126
140-20	16	903 001 140 020		2,450	5	74	262	153	126
160-63	16	903 001 160 063		2,550	5	100	272	163	152
160-50	16	903 001 160 050		2,520	5	74	272	163	126
160-40	16	903 001 160 040		2,510	5	74	272	163	126
160-32	16	903 001 160 032		2,490	5	74	272	163	126
160-25	16	903 001 160 025		2,470	5	74	272	163	126
160-20	16	903 001 160 020		2,460	5	74	272	163	126

EF Servis Te
 EF Service Tee

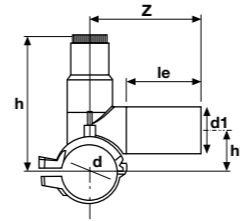
PE 100 SDR11

Çap Dia	Basınç PN	Kod Code	Fiyat (€/Adet) Price (€/Pcs)	Kg /Adet Kg/Pcs	Koli/Adet Box/Pcs	le (mm)	H (mm)	H1 (mm)	Z (mm)
40-32	16	903 002 040 032		0,333	20	76	135	38	114
40-25	16	903 002 040 025		0,323	20	75	135	38	114
40-20	16	903 002 040 020		0,313	20	67	135	38	104
50-32	16	903 002 050 032		0,333	20	76	135	43	117
50-25	16	903 002 050 025		0,323	20	75	135	43	113
50-20	16	903 002 050 020		0,313	20	64	135	43	105
63-63	16	903 002 063 063		0,675	18	107	180	51	149
63-50	16	903 002 063 050		0,628	20	92	180	51	138
63-40	16	903 002 063 040		0,593	20	85	180	51	126
63-32	16	903 002 063 032		0,588	20	76	180	51	117
63-25	16	903 002 063 025		0,578	20	75	180	51	116
63-20	16	903 002 063 020		0,578	20	75	180	51	116
75-63	16	903 002 075 063		0,697	15	107	186	56	152
75-50	16	903 002 075 050		0,644	15	92	186	56	140
75-40	16	903 002 075 040		0,624	15	82	186	56	126
75-32	16	903 002 075 032		0,597	15	76	186	56	118
75-25	16	903 002 075 025		0,590	15	75	186	56	117
75-20	16	903 002 075 020		0,590	15	75	186	56	113
90-63	16	903 002 090 063		0,788	12	100	195	65	160
90-50	16	903 002 090 050		0,730	12	92	195	65	148
90-40	16	903 002 090 040		0,696	12	85	195	65	136
90-32	16	903 002 090 032		0,680	12	76	195	65	120
90-25	16	903 002 090 025		0,680	12	75	195	65	120
90-20	16	903 002 090 020		0,680	12	75	195	65	120
110-63	16	903 002 110 063		0,836	10	100	200	75	165
110-50	16	903 002 110 050		0,786	10	92	200	75	156
110-40	16	903 002 110 040		0,756	10	84	200	75	140
110-32	16	903 002 110 032		0,726	10	76	200	75	126
110-25	16	903 002 110 025		0,716	10	75	200	75	120
110-20	16	903 002 110 020		0,716	10	75	200	75	120
125-63	16	903 002 125 063		0,882	8	100	212	82	170
125-50	16	903 002 125 050		0,819	8	92	212	82	160
125-40	16	903 002 125 040		0,782	8	85	212	82	143
125-32	16	903 002 125 032		0,757	8	76	212	82	129
125-25	16	903 002 125 025		0,757	8	75	212	82	120
125-20	16	903 002 125 020		0,757	8	75	212	82	120
140-63	16	903 002 140 063		0,976	6	100	238	95	182
140-50	16	903 002 140 050		0,926	6	92	238	95	164
140-40	16	903 002 140 040		0,859	6	85	238	95	150
140-32	16	903 002 140 032		0,826	6	76	238	95	134
140-25	16	903 002 140 025		0,826	6	75	238	95	126
140-20	16	903 002 140 020		0,809	6	75	238	95	125
160-63	16	903 002 160 063		0,993	6	100	247	105	185
160-50	16	903 002 160 050		0,926	6	92	247	105	171
160-40	16	903 002 160 040		0,893	6	85	247	105	156
160-32	16	903 002 160 032		0,893	6	76	247	105	141
160-25	16	903 002 160 025		0,893	6	75	247	105	127
160-20	16	903 002 160 020		0,859	6	75	247	105	124
180-63	16	903 002 180 063		1,031	5	100	250	115	192
180-50	16	903 002 180 050		0,971	5	92	250	115	175
180-40	16	903 002 180 040		0,931	5	85	250	115	160
180-32	16	903 002 180 032		0,911	5	76	250	115	143
180-25	16	903 002 180 025		0,891	5	75	250	115	127
180-20	16	903 002 180 020		0,871	5	75	250	115	127

Not / Note

HDPE

SPIGOT EK PARÇALAR SPIGOT FITTINGS

ÜRETİM STANDARDI

PRODUCTION STANDARD

TS EN 12201-3 +A1

ÇAP / SIZE Ø20 - Ø630



 **PIMTAŞ**[®]

Since 1977

90° Dirsek Spigot Enjeksiyon
 90° Elbow Spigot Injection

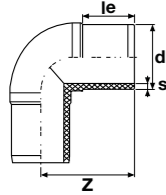
PE100 SDR11

Çap Dia	Basınç PN	Kod Code	Fiyat (Adet) Price (Pcs)	Kg /Adet Kg/Pcs	Koli/Adet Box/Pcs	le (mm)	Z (mm)	s (mm)
20	16	900 30 020 2		0,020	60	41	63	3,0
25	16	900 30 025 2		0,030	60	41	63	3,0
32	16	900 30 032 2		0,042	50	44	72	3,0
40	16	900 30 040 2		0,072	42	49	80	3,7
50	16	900 30 050 2		0,132	25	55	92	4,6
63	16	900 30 063 2		0,214	30	63	111	5,8
75	16	900 30 075 2		0,418	30	70	126	6,8
90	16	900 30 090 2		0,654	20	79	145	8,2
110	16	900 30 110 2		1,084	12	82	161	10
125	16	900 30 125 2		1,448	12	87	169	11,4
140	16	900 30 140 2		2,152	8	92	195	12,7
160	16	900 30 160 2		2,934	4	98	205	14,6
180	16	900 30 180 2		4,000	4	105	225	16,4
200	16	900 30 200 2		5,892	4	112	245	18,2
225	16	900 30 225 2		7,220	2	120	264	20,5
250	16	900 30 250 2		10,200	1	130	284	22,7
280	16	900 30 280 2		15,442	1	139	327	25,4
315	16	900 30 315 2		20,830	1	150	358	28,6
355	16	900 30 355 2		30,420	1	165	401	32,3
400	16	900 30 400 2		43,330	1	180	451	36,4

PE100 SDR17

Çap Dia	Basınç PN	Kod Code	Fiyat (Adet) Price (Pcs)	Kg /Adet Kg/Pcs	Koli/Adet Box/Pcs	le (mm)	Z (mm)	s (mm)
63	10	900 30 063 1		0,215	30	63	111	3,8
75	10	900 30 075 1		0,312	30	70	126	4,5
90	10	900 30 090 1		0,472	20	79	145	5,4
110	10	900 30 110 1		0,768	12	82	161	6,6
125	10	900 30 125 1		1,040	12	87	169	7,4
140	10	900 30 140 1		1,488	8	92	195	8,3
160	10	900 30 160 1		2,218	4	98	205	9,5
180	10	900 30 180 1		2,864	4	105	225	10,7
200	10	900 30 200 1		4,362	4	112	245	11,9
225	10	900 30 225 1		5,168	2	120	264	13,4
250	10	900 30 250 1		7,476	1	130	284	14,8
280	10	900 30 280 1		11,430	1	139	327	16,6
315	10	900 30 315 1		15,684	1	150	358	18,7
355	10	900 30 355 1		21,100	1	164	401	21,1
400	10	900 30 400 1		30,450	1	179	451	23,7

45° Dirsek Spigot Enjeksiyon
 45° Elbow Spigot Injection

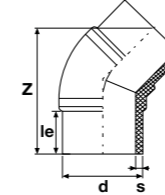
PE100 SDR11

Çap Dia	Basınç PN	Kod Code	Fiyat (Adet) Price (Pcs)	Kg /Adet Kg/Pcs	Koli/Adet Box/Pcs	le (mm)	L (mm)	Z (mm)	s (mm)
20	16	900 50 020 2		0,027	60	41	70	119	3,0
25	16	900 50 025 2		0,036	50	41	73	128	3,0
32	16	900 50 032 2		0,057	50	44	79	136	3,0
40	16	900 50 040 2		0,099	32	49	85	145	3,7
50	16	900 50 050 2		0,136	25	55	89	153	4,6
63	16	900 50 063 2		0,211	30	63	93	162	5,8
75	16	900 50 075 2		0,329	30	70	102	179	6,8
90	16	900 50 090 2		0,560	24	79	118	204	8,2
110	16	900 50 110 2		0,951	18	82	128	222	10
125	16	900 50 125 2		1,290	12	87	139	239	11,4
140	16	900 50 140 2		1,693	12	92	145	247	12,7
160	16	900 50 160 2		2,398	9	98	159	273	14,6
180	16	900 50 180 2		3,233	4	105	168	290	16,4
200	16	900 50 200 2		4,451	4	112	179	315	18,2
225	16	900 50 225 2		5,815	2	120	198	341	20,5
250	16	900 50 250 2		7,908	2	129	213	370	22,7
280	16	900 50 280 2		11,255	1	139	235	406	25,4
315	16	900 50 315 2		14,170	1	150	249	430	28,6
355	16	900 50 355 2		22,530	1	164	284	490	32,3
400	16	900 50 400 2		32,020	1	179	317	548	36,4

PE100 SDR17

Çap Dia	Basınç PN	Kod Code	Fiyat (€/Adet) Price (€/Pcs)	Kg /Adet Kg/Pcs	Koli/Adet Box/Pcs	le (mm)	le (mm)	Z (mm)	s (mm)
63	10	900 50 063 1		0,164	42	63	93	160	3,8
75	10	900 50 075 1		0,239	30	70	102	176	4,5
90	10	900 50 090 1		0,410	24	79	118	202	5,4
110	10	900 50 110 1		0,689	18	82	128	220	6,6
125	10	900 50 125 1		0,906	12	87	139	239	7,4
140	10	900 50 140 1		1,201	12	92	145	250	8,3
160	10	900 50 160 1		1,764	9	98	159	273	9,5
180	10	900 50 180 1		2,283	4	105	168	290	10,7
200	10	900 50 200 1		3,276	4	112	179	311	11,9
225	10	900 50 225 1		4,215	2	120	198	341	13,4
250	10	900 50 250 1		5,908	2	129	213	368	14,8
280	10	900 50 280 1		8,055	1	139	235	406	16,6
315	10	900 50 315 1		10,270	1	150	249	430	18,7
355	10	900 50 355 1		15,470	1	164	284	490	21,1
400	10	900 50 400 1		21,920	1	179	317	548	23,7

Eşit- Te Spigot Enjeksiyon
 Equal-Tee Spigot Injection

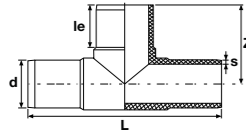
PE100 SDR11

Çap Dia	Basınç PN	Kod Code	Fiyat (Adet) Price (Pcs)	Kg /Adet Kg/Pcs	Koli/Adet Box/Pcs	le (mm)	L (mm)	Z (mm)	s (mm)
20	16	900 40 020 2		0,038	50	41	148	74	3,0
25	16	900 40 025 2		0,054	40	41	158	78	3,0
32	16	900 40 032 2		0,074	30	44	170	86	3,0
40	16	900 40 040 2		0,134	50	49	188	90	3,7
50	16	900 40 050 2		0,242	47	55	225	109	4,6
63	16	900 40 063 2		0,384	36	63	225	117	5,8
75	16	900 40 075 2		0,560	22	70	268	134	6,8
90	16	900 40 090 2		0,892	14	79	290	142	8,2
110	16	900 40 110 2		1,580	14	82	332	166	10,0
125	16	900 40 125 2		2,204	8	87	362	181	11,4
140	16	900 40 140 2		2,751	6	92	378	189	12,7
160	16	900 40 160 2		4,130	4	98	422	211	14,6
180	16	900 40 180 2		5,658	3	105	455	225	16,4
200	16	900 40 200 2		7,490	2	112	481	240	18,2
225	16	900 40 225 2		10,126	2	120	527	263	20,5
250	16	900 40 250 2		13,768	2	130	590	295	22,7
280	16	900 40 280 2		21,564	1	139	690	345	25,4
315	16	900 40 315 2		27,066	1	150	710	346	28,6
355	16	900 40 355 2		36,830	1	164	789	394	32,3
400	16	900 40 400 2		55,760	1	179	877	439	36,4

PE100 SDR17

Çap Dia	Basınç PN	Kod Code	Fiyat (Adet) Price (Pcs)	Kg /Adet Kg/Pcs	Koli/Adet Box/Pcs	le (mm)	L (mm)	Z (mm)	s (mm)
63	10	900 40 063 1		0,310	36	63	225	114	3,8
75	10	900 40 075 1		0,434	22	70	261	130	4,5
90	10	900 40 090 1		0,676	14	79	290	142	5,4
110	10	900 40 110 1		1,232	14	82	327	162	6,6
125	10	900 40 125 1		1,626	8	87	356	178	7,4
140	10	900 40 140 1		2,028	6	92	378	189	8,3
160	10	900 40 160 1		3,076	4	98	417	208	9,5
180	10	900 40 180 1		4,140	3	105	458	225	10,7
200	10	900 40 200 1		5,222	2	112	481	236	11,9
225	10	900 40 225 1		7,350	2	120	527	260	13,4
250	10	900 40 250 1		9,858	2	130	590	292	14,8
280	10	900 40 280 1		15,856	1	139	690	340	16,6
315	10	900 40 315 1		19,200	1	150	712	352	18,7
355	10	900 40 355 1		27,280	1	164	789	394	21,1
400	10	900 40 400 1		38,250	1	179	877	439	23,7

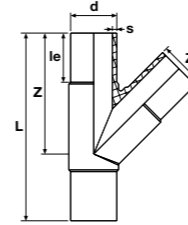
45° Çatal Te Enjeksiyon
 45° Wye Tee Spigot Injection

PE 100 SDR11

Çap Dia	Basınç PN	Kod Code	Fiyat (Adet) Price (Pcs)	Kg /Adet Kg/Pcs	Koli/Adet Box/Pcs	L (mm)	le (mm)	Z (mm)	s (mm)
63	16	900 41 063 2		0,474	22	254	63	164	5,8
75	16	900 41 075 2		0,693	20	284	70	185	6,8
90	16	900 41 090 2		1,150	11	321	79	213	8,2
110	16	900 41 110 2		1,580	9	376	82	251	10,0
125	16	900 41 125 2		1,964	5	412	87	277	11,4
160	16	900 41 160 2		2,860	30	531	98	356	14,6
180	16	900 41 180 2		8,590	20	578	105	394	16,4
200	16	900 41 200 2		11,350	13	630	112	430	18,2
225	16	900 41 225 2		15,790	10	692	120	475	20,5
250	16	900 41 250 2		20,130	8	729	129	507	22,7

PE 100 SDR17

Çap Dia	Basınç PN	Kod Code	Fiyat (Adet) Price (Pcs)	Kg /Adet Kg/Pcs	Koli/Adet Box/Pcs	L (mm)	le (mm)	Z (mm)	s (mm)
63	10	900 41 063 1		0,474	22	254	63	164	3,8
75	10	900 41 075 1		0,693	20	284	70	185	4,5
90	10	900 41 090 1		1,150	11	321	79	213	5,4
110	10	900 41 110 1		1,580	9	376	82	251	6,6
125	10	900 41 125 1		1,964	5	412	87	277	7,4
160	10	900 41 160 1		2,860	30	531	98	356	9,5
180	10	900 41 180 1		8,590	20	578	105	394	10,7
200	10	900 41 200 1		11,350	13	630	112	430	11,9
225	10	900 41 225 1		15,790	10	692	120	475	13,4
250	10	900 41 250 1		20,130	8	729	129	507	14,8

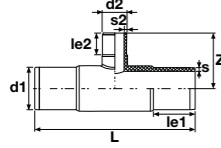
İnegal Te Spigot Enjeksiyon
 Reducing Tee Spigot Injection

PE100 SDR11

Çap Dia	Basınç PN	Kod Code	Fiyat (Adet) Price (Pcs)	Kg /Adet Kg/Pcs	Koli/Adet Box/Pcs	L (mm)	le1 (mm)	le2 (mm)	Z (mm)	S1 (mm)	S2 (mm)
50-40	16	900 70 5040 2		0,210	32	229	55	49	94	4,6	3,7
50-32	16	900 70 5032 2		0,192	32	229	55	44	88	4,6	3,0
50-25	16	900 70 5025 2		0,180	32	229	55	41	85	4,6	3,0
63-50	16	900 70 6350 2		0,346	36	216	63	55	103	5,8	4,6
63-40	16	900 70 6340 2		0,312	36	216	63	49	95	5,8	3,7
63-32	16	900 70 6332 2		0,304	36	216	63	44	89	5,8	3,0
75-63	16	900 70 7563 2		0,522	22	261	70	63	121	6,8	5,8
75-50	16	900 70 7550 2		0,480	22	261	70	55	113	6,8	4,6
75-40	16	900 70 7540 2		0,454	22	261	70	49	106	6,8	3,7
75-32	16	900 70 7532 2		0,450	22	260	70	44	100	6,8	3,0
90-75	16	900 70 9075 2		0,834	14	290	79	70	136	8,2	6,8
90-63	16	900 70 9063 2		0,779	14	290	79	63	132	8,2	5,8
90-50	16	900 70 9050 2		0,748	14	290	79	55	124	8,2	4,6
110-90	16	900 70 11090 2		1,422	14	327	82	79	157	10,0	8,2
110-75	16	900 70 11075 2		1,356	14	327	82	70	151	10,0	6,8
110-63	16	900 70 11063 2		1,318	14	327	82	63	149	10,0	5,8
110-50	16	900 70 11050 2		1,282	14	327	82	55	147	10,0	4,6
110-32	16	900 70 11032 2		1,232	14	327	82	55	140	10,0	3,0
125-110	16	900 70 125110 2		2,082	8	356	87	82	176	11,4	10,0
125-90	16	900 70 12590 2		2,000	8	356	87	79	172	11,4	8,2
125-63	16	900 70 12563 2		1,740	8	356	87	63	154	11,4	5,8
140-125	16	900 70 140125 2		2,612	6	380	92	87	184	12,7	11,4
140-110	16	900 70 140110 2		2,542	6	380	92	82	179	12,7	10,0
140-90	16	900 70 14090 2		2,414	6	380	92	79	175	12,7	8,2
160-140	16	900 70 160140 2		3,838	4	417	98	92	200	14,6	12,7
160-125	16	900 70 160125 2		3,754	4	417	98	87	200	14,6	11,4
160-110	16	900 70 160110 2		3,660	4	417	98	82	195	14,6	10,0
160-90	16	900 70 16090 2		3,334	5	417	98	79	187	14,6	8,2
160-75	16	900 70 16075 2		3,428	5	417	98	70	182	14,6	6,8
160-63	16	900 70 16063 2		3,430	5	417	98	63	175	14,6	5,8
180-160	16	900 70 180160 2		5,346	3	458	105	98	222	16,4	14,6
180-125	16	900 70 180125 2		5,086	3	458	105	87	215	16,4	11,4
180-110	16	900 70 180110 2		4,950	3	458	105	82	210	16,4	10,0
180-90	16	900 70 18090 2		4,818	3	458	105	79	206	16,4	8,2
200-160	16	900 70 200160 2		6,820	3	481	112	98	227	18,2	14,6
200-125	16	900 70 200125 2		6,464	3	481	112	87	225	18,2	11,4
200-110	16	900 70 200110 2		6,324	3	481	112	82	211	18,2	10,0
200-90	16	900 70 20090 2		6,200	3	481	112	79	207	18,2	8,2
200-63	16	900 70 20063 2		6,170	3	481	112	63	191	18,2	5,8
225-160	16	900 70 225160 2		9,120	2	527	120	98	242	20,5	14,6
225-125	16	900 70 225125 2		8,930	2	527	120	87	239	20,5	11,4
225-110	16	900 70 225110 2		8,750	2	527	120	82	226	20,5	10,0
225-90	16	900 70 22590 2		8,728	2	527	120	79	222	20,5	8,2
250-225	16	900 70 250225 2		13,264	2	590	129	120	285	22,7	20,5
250-200	16	900 70 250200 2		12,607	2	590	129	112	278	22,7	18,2
250-160	16	900 70 250160 2		11,950	2	590	129	98	267	22,7	14,6
250-125	16	900 70 250125 2		11,630	2	590	129	87	252	22,7	11,4
250-110	16	900 70 250110 2		11,690	2	590	129	82	251	22,7	10,0
250-90	16	900 70 25090 2		11,428	2	590	129	79	243	22,7	8,2
280-250	16	900 70 280250 2		20,175	1	685	139	129	331	25,4	22,7
280-225	16	900 70 280225 2		19,700	1	690	139	120	320	25,4	20,5
280-200	16	900 70 280200 2		18,932	1	690	139	112	316	25,4	18,2
280-160	16	900 70 280160 2		18,186	1	690	139	98	302	25,4	14,6
280-110	16	900 70 280110 2		17,890	1	690	139	82	290	25,4	10,0
315-250	16	900 70 315250 2		25,420	1	712	150	129	332	28,6	22,7
315-225	16	900 70 315225 2		24,920	1	712	150	120	325	28,6	20,5
315-200	16	900 70 315200 2		24,300	1	712	150	112	317	28,6	18,2
315-160	16	900 70 315160 2		23,860	1	712	150	98	303	28,6	14,6
315-110	16	900 70 315110 2		22,746	1	712	150	82	293	28,6	10,0

İnegal Te Spigot Enjeksiyon
 Reducing Tee Spigot Injection

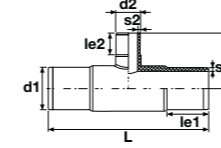
PE100 SDR17

Çap Dia	Basınç PN	Kod Code	Fiyat (Adet) Price (Pcs)	Kg /Adet Kg/Pcs	Koli/Adet Box/Pcs	L (mm)	le1 (mm)	le2 (mm)	Z (mm)	S1 (mm)	S2 (mm)
75-63	10	900 70 7563 1		0,382	22	261	70	63	121	4,5	3,8
90-75	10	900 70 9075 1		0,612	14	290	79	70	136	5,4	4,5
90-63	10	900 70 9063 1		0,614	14	290	79	63	132	5,4	3,8
110-90	10	900 70 11090 1		1,100	14	327	82	79	157	6,6	5,4
110-75	10	900 70 11075 1		1,034	14	327	82	70	151	6,6	4,5
110-63	10	900 70 11063 1		1,020	14	327	82	63	149	6,6	3,8
125-110	10	900 70 125110 1		1,522	8	356	87	82	176	7,4	6,6
125-90	10	900 70 12590 1		1,420	8	356	87	79	172	7,4	5,4
125-63	10	900 70 12563 1		1,260	8	356	87	63	154	7,4	3,8
140-125	10	900 70 140125 1		1,826	6	380	92	87	184	8,3	7,4
140-110	10	900 70 140110 1		1,816	6	380	92	82	179	8,3	6,6
140-90	10	900 70 14090 1		1,700	6	380	92	79	175	8,3	5,4
160-140	10	900 70 160140 1		2,900	4	417	98	92	200	9,5	8,3
160-125	10	900 70 160125 1		2,742	4	417	98	87	200	9,5	7,4
160-110	10	900 70 160110 1		2,714	4	417	98	82	195	9,5	6,6
160-90	10	900 70 16090 1		2,642	5	417	98	79	187	9,5	5,4
160-75	10	900 70 16075 1		2,590	5	417	98	70	182	9,5	4,5
160-63	10	900 70 16063 1		2,536	5	417	98	63	175	9,5	3,8
180-160	10	900 70 180160 1		3,858	3	458	105	98	226	10,7	9,5
180-125	10	900 70 180125 1		3,682	3	458	105	87	215	10,7	7,4
180-110	10	900 70 180110 1		3,612	3	458	105	82	210	10,7	6,6
180-90	10	900 70 18090 1		3,540	3	458	105	79	206	10,7	5,4
200-160	10	900 70 200160 1		4,854	3	481	112	98	227	11,9	9,5
200-125	10	900 70 200125 1		4,686	3	481	112	87	225	11,9	7,4
200-110	10	900 70 200110 1		4,545	3	481	112	82	211	11,9	6,6
200-90	10	900 70 20090 1		4,426	3	481	112	79	207	11,9	5,4
200-63	10	900 70 20063 1		4,427	3	481	112	63	190	11,9	3,8
225-160	10	900 70 225160 1		6,652	2	527	120	98	242	13,4	9,5
225-125	10	900 70 225125 1		6,400	2	527	120	87	239	13,4	7,4
225-110	10	900 70 225110 1		6,344	2	527	120	82	226	13,4	6,6
225-90	10	900 70 22590 1		6,270	2	527	120	79	222	13,4	5,4
250-225	10	900 70 250225 1		9,494	2	590	129	120	285	14,8	13,4
250-200	10	900 70 250200 1		9,109	2	590	129	112	278	14,8	11,9
250-160	10	900 70 250160 1		8,724	2	590	129	98	267	14,8	9,5
250-125	10	900 70 250125 1		8,500	2	590	129	87	252	14,8	7,4
250-110	10	900 70 250110 1		8,382	2	590	129	82	251	14,8	6,6
250-90	10	900 70 25090 1		8,550	2	590	129	79	243	14,8	5,4
280-250	10	900 70 280250 1		14,478	1	690	139	129	334	16,6	14,8
280-225	10	900 70 280225 1		14,160	1	690	139	120	320	16,6	13,4
280-200	10	900 70 280200 1		13,950	1	690	139	112	316	16,6	11,9
280-160	10	900 70 280160 1		13,650	1	690	139	98	302	16,6	9,5
280-110	10	900 70 280110 1		13,330	1	690	139	82	290	16,6	6,6
315-250	10	900 70 315250 1		17,640	1	712	150	129	332	18,7	14,8
315-225	10	900 70 315225 1		17,000	1</						

Kör Tapa Spigot Enjeksiyon
 End Cap Spigot Injection

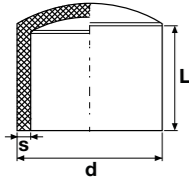
PE100 SDR11

Çap Dia	Basınç PN	Kod Code	Fiyat (Adet) Price (Pcs)	Kg /Adet Kg/Pcs	Koli/Adet Box/Pcs	L (mm)	s (mm)
20	16	900 60 020 2		0,008	100	41	3,0
25	16	900 60 025 2		0,012	100	41	3,0
32	16	900 60 032 2		0,016	100	44	3,0
40	16	900 60 040 2		0,028	60	49	3,7
50	16	900 60 050 2		0,048	50	55	4,6
63	16	900 60 063 2		0,088	36	63	5,8
75	16	900 60 075 2		0,142	27	70	6,8
90	16	900 60 090 2		0,234	60	79	8,2
110	16	900 60 110 2		0,374	36	82	10,0
125	16	900 60 125 2		0,542	24	87	11,4
140	16	900 60 140 2		0,748	22	92	12,7
160	16	900 60 160 2		1,022	15	98	14,6
180	16	900 60 180 2		1,416	8	105	16,4
200	16	900 60 200 2		1,888	10	112	18,2
225	16	900 60 225 2		2,520	4	120	20,5
250	16	900 60 250 2		3,240	4	129	22,7
280	16	900 60 280 2		4,580	3	139	25,4
315	16	900 60 315 2		6,310	2	150	28,6
355	16	900 60 355 2		8,700	2	164	32,3
400	16	900 60 400 2		12,440	1	179	36,4

PE100 SDR17

Çap Dia	Basınç PN	Kod Code	Fiyat (Adet) Price (Pcs)	Kg /Adet Kg/Pcs	Koli/Adet Box/Pcs	L (mm)	s (mm)
63	10	900 60 063 1		0,079	36	63	3,8
75	10	900 60 075 1		0,117	27	70	4,5
90	10	900 60 090 1		0,205	60	79	5,4
110	10	900 60 110 1		0,308	36	82	6,6
125	10	900 60 125 1		0,436	24	87	7,4
140	10	900 60 140 1		0,621	22	92	8,3
160	10	900 60 160 1		0,863	15	98	9,5
180	10	900 60 180 1		1,135	8	105	10,7
200	10	900 60 200 1		1,518	10	112	11,9
225	10	900 60 225 1		2,113	4	120	13,4
250	10	900 60 250 1		2,764	4	129	14,8
280	10	900 60 280 1		3,761	3	139	16,6
315	10	900 60 315 1		5,191	2	150	18,7
355	10	900 60 355 1		7,465	2	164	21,1
400	10	900 60 400 1		10,640	1	179	23,7

Flaş Adaptörü Enjeksiyon
 Equal-Tee Spigot Injection

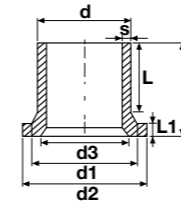
PE100 SDR11

Çap Dia	Basınç PN	Kod Code	Fiyat (Adet) Price (Pcs)	Kg /Adet Kg/Pcs	Koli/Adet Box/Pcs	d1 (mm)	d2 (mm)	d3 (mm)	L (mm)	L1 (mm)	Z (mm)	s (mm)
20	16	900 90 020 2		0,024	100	28	45		55	7	80	3,0
25	16	900 90 025 2		0,038	50	34	58		62	9	81	3,0
32	16	900 90 032 2		0,052	40	42	68		61	10	86	3,0
40	16	900 90 040 2		0,082	70	51	78		60	11	88	3,7
50	16	900 90 050 2		0,122	50	62	88		63	12	92	4,6
63	16	900 90 063 2		0,200	60	78	102		88	14	120	5,8
75	16	900 90 075 2		0,310	60	92	122		97	16	130	6,8
90	16	900 90 090 2		0,440	45	108	138		103	17	140	8,2
110	16	900 90 110 2		0,680	24	125	158		113	18	155	10,0
125	16	900 90 125 2		0,780	16	135	158		120	20	159	11,4
140	16	900 90 140 2		1,318	12	155	188		128	25	190	12,7
160	16	900 90 160 2		1,620	12	175	212	154	155	25	200	14,6
180	16	900 90 180 2		1,960	10	188	212	158	152	30	207	16,4
200	16	900 90 200 2		2,680	4	232	268	208	153	32	210	18,2
225	16	900 90 225 2		3,108	4	235	268	208	139	32	196	20,5
250	16	900 90 250 2		3,782	2	288	320	260	140	35	205	22,7
280	16	900 90 280 2		4,724	2	288	320	260	145	35	211	25,4
315	16	900 90 315 2		6,346	2	338	375	305	160	35	224	28,6
355	16	900 90 355 2		9,188	1	376	435	345	172	45	240	32,3
400	16	900 90 400 2		12,700	1	430	485	396	181	50	264	36,4
*450	16	900 90 450 2										
*500	16	900 90 500 2										
*560	16	900 90 560 2										
*630	16	900 90 630 2										

PE100 SDR17

Çap Dia	Basınç PN	Kod Code	Fiyat (Adet) Price (Pcs)	Kg /Adet Kg/Pcs	Koli/Adet Box/Pcs	d1 (mm)	d2 (mm)	d3 (mm)	L (mm)	L1 (mm)	Z (mm)	s (mm)
63	10	900 90 063 1		0,160	60	78	102		88	14	120	3,8
75	10	900 90 075 1		0,272	60	92	122		97	16	130	4,5
90	10	900 90 090 1		0,350	45	108	139		106	17	140	5,4
110	10	900 90 110 1		0,530	24	125	158		113	17	155	6,6
125	10	900 90 125 1		0,570	16	135	158		120	20	160	7,4
140	10	900 90 140 1		1,108	12	155	188		128	18	188	8,3
160	10	900 90 160 1		1,070	12	175	212	154	147	18	185	9,5
180	10	900 90 180 1		1,110	12	188	212	164	111	20	153	10,7
200	10	900 90 200 1		1,912	4	230	268	208	125	24	188	11,9
225	10	900 90 225 1		2,316	4	238	268	208	156	24	205	13,4
250	10	900 90 250 1		2,841	2	288	320	260	133	25	186	14,8
280	10	900 90 280 1		3,958	2	288	320	260	148	25	213	16,6
315	10	900 90 315 1		4,470	2	338	375	305	166	25	223	18,7
355	10	900 90 355 1		6,062	1	376	435	350	174	30	227	21,1
400	10	900 90 400 1		8,328	1	430	485	396	185	33	242	23,7

Redüksiyon Spigot Enjeksiyon
 Reducer Spigot Injection

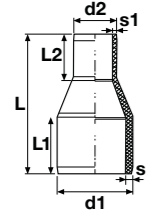
Redüksiyon Spigot Enjeksiyon
 Reducer Spigot Injection

PE100 SDR11

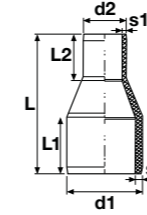
Çap Dia	Basınç PN	Kod Code	Fiyat (Adet) Price (Pcs)	Kg /Adet Kg/Pcs	Koli/Adet Box/Pcs	L (mm)	L1 (mm)	L2 (mm)	S1 (9)	S2 (mm)
25-20	16	900 80 2520 2		0,024	80	120	41	41	3,0	3,0
32-25	16	900 80 3225 2		0,034	50	130	44	41	3,0	3,0
32-20	16	900 80 3220 2		0,030	50	115	44	41	3,0	3,0
40-32	16	900 80 4032 2		0,052	50	130	49	44	3,7	3,0
40-25	16	900 80 4025 2		0,042	50	130	49	41	3,7	3,0
50-40	16	900 80 5040 2		0,078	40	140	55	49	4,6	3,7
50-32	16	900 80 5032 2		0,074	40	140	55	44	4,6	3,0
50-25	16	900 80 5025 2		0,068	40	140	55	41	4,6	3,0
63-50	16	900 80 6350 2		0,140	20	150	63	55	5,8	4,6
63-40	16	900 80 6340 2		0,116	20	150	63	49	5,8	3,7
63-32	16	900 80 6332 2		0,112	20	150	63	44	5,8	3,0
63-25	16	900 80 6325 2		0,106	20	143	63	41	5,8	3,0
75-63	16	900 80 7563 2		0,232	36	175	70	63	6,8	5,8
75-50	16	900 80 7550 2		0,194	36	175	70	55	6,8	4,6
75-40	16	900 80 7540 2		0,166	36	170	70	49	6,8	3,7
75-32	16	900 80 7532 2		0,164	36	170	70	44	6,8	3,0
90-75	16	900 80 9075 2		0,390	36	200	79	70	8,2	6,8
90-63	16	900 80 9063 2		0,302	36	196	79	63	8,2	5,8
90-50	16	900 80 9050 2		0,288	36	190	79	55	8,2	4,6
110-90	16	900 80 11090 2		0,586	30	213	82	79	10,0	8,2
110-75	16	900 80 11075 2		0,546	30	216	82	70	10,0	6,8
110-63	16	900 80 11063 2		0,496	30	214	82	63	10,0	5,8
110-50	16	900 80 11050 2		0,410	30	208	82	55	10,0	4,6
125-110	16	900 80 125110 2		0,844	18	222	87	82	11,4	10,0
125-90	16	900 80 12590 2		0,729	24	222	87	79	11,4	8,2
125-75	16	900 80 12575 2		0,642	24	215	87	70	11,4	6,8
125-63	16	900 80 12563 2		0,602	24	195	87	63	11,4	5,8
140-125	16	900 80 140125 2		1,090	16	225	92	87	12,7	11,4
140-110	16	900 80 140110 2		1,002	16	233	92	82	12,7	10,0
140-90	16	900 80 14090 2		0,824	16	225	92	79	12,7	8,2
140-75	16	900 80 14075 2		0,826	16	225	92	70	12,7	6,8
160-140	16	900 80 160140 2		1,468	16	245	98	92	14,6	12,7
160-125	16	900 80 160125 2		1,442	16	250	98	87	14,6	11,4
160-110	16	900 80 160110 2		1,280	16	250	98	82	14,6	10
160-90	16	900 80 16090 2		1,220	16	245	98	79	14,6	8,2
180-160	16	900 80 180160 2		2,068	6	255	105	98	16,4	14,6
180-140	16	900 80 180140 2		1,800	6	250	105	92	16,4	12,7
180-125	16	900 80 180125 2		1,646	6	255	105	87	16,4	11,4
180-110	16	900 80 180110 2		1,588	6	225	105	82	16,4	10,0
200-180	16	900 80 200180 2		2,654	8	275	112	105	18,2	16,4
200-160	16	900 80 200160 2		2,364	8	270	112	98	18,2	14,6
200-140	16	900 80 200140 2		2,342	8	275	112	92	18,2	12,7
200-110	16	900 80 200110 2		2,192	8	275	112	82	18,2	10,0
225-200	16	900 80 225200 2		3,758	5	300	120	112	20,5	18,2
225-180	16	900 80 225180 2		3,336	5	280	120	105	20,5	16,4
225-160	16	900 80 225160 2		3,024	5	280	120	98	20,5	14,6
225-110	16	900 80 225110 2		2,848	6	295	120	82	20,5	10,0
250-225	16	900 80 250225 2		4,708	2	305	129	120	22,7	20,5
250-200	16	900 80 250200 2		4,346	2	310	129	112	22,7	18,2
250-180	16	900 80 250180 2		4,208	2	305	129	105	22,7	16,4
250-160	16	900 80 250160 2		3,542	2	294	129	98	22,7	14,6
280-250	16	900 80 280250 2		6,818	2	348	139	129	25,4	22,7
280-225	16	900 80 280225 2		6,050	2	336	139	120	25,4	20,5
280-200	16	900 80 280200 2		5,758	2	348	139	112	25,4	18,2
280-180	16	900 80 280180 2		5,390	2	348	139	105	25,4	16,4
315-280	16	900 80 315280 2		8,678	2	355	150	139	28,6	25,4
315-250	16	900 80 315250 2		8,066	2	375	150	129	28,6	22,7
315-225	16	900 80 315225 2		7,652	2	375	150	120	28,6	20,5
355-315	16	900 80 355315 2		11,290	1	390	164	150	32,3	28,6
400-315	16	900 80 400315 2		14,560	1	430	179	150	36,4	28,6

PE100 SDR17

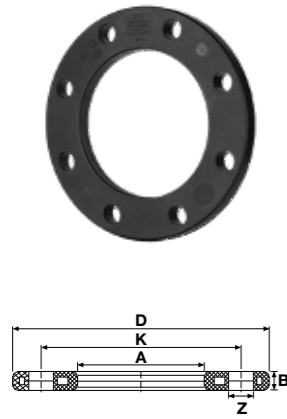
Çap Dia	Basınç PN	Kod Code	Fiyat (Adet) Price (Pcs)	Kg /Adet Kg/Pcs	Koli/Adet Box/Pcs	L (mm)	L1 (mm)	L2 (mm)	S1 (mm)	S2 (mm)
75-63	10	900 80 7563 1		0,199	36	175	70	63	4,5	3,8
90-75	10	900 80 9075 1		0,320	36	200	79	70	5,4	4,5
90-63	10	900 80 9063 1		0,258	36	196	79	63	5,4	3,8
110-90	10	900 80 11090 1		0,498	30	213	82	79	6,6	5,4
110-75	10	900 80 11075 1		0,463	30	216	82	70	6,6	4,5
110-63	10	900 80 11063 1		0,421	30	214	82	63	6,6	3,8
125-110	10	900 80 125110 1		0,717	18	222	87	82	7,4	6,6
125-90	10	900 80 12590 1		0,619	24	222	87	79	7,4	5,4
125-75	10	900 80 12575 1		0,545	24	215	87	70	7,4	4,5
125-63	10	900 80 12563 1		0,511	24	195	87	63	7,4	3,8
140-125	10	900 80 140125 1		0,926	16	225	92	87	8,3	7,4
140-110	10	900 80 140110 1		0,817	16	233	92	82	8,3	6,6
140-90	10	900 80 14090 1		0,700	16	225	92	79	8,3	5,4
140-75	10	900 80 14075 1		0,702	16	225	92	70	8,3	4,5
160-140	10	900 80 160140 1		1,247	16	245	98	92	9,5	8,3
160-125	10	900 80 160125 1		1,225	16	250	98	87	9,5	7,4
160-110	10	900 80 160110 1		1,088	16	250	98	82	9,5	6,6
160-90	10	900 80 16090 1		1,038	16	245	98	79	9,5	5,4
180-160	10	900 80 180160 1		1,757	6	255	105	98	10,7	9,5
180-140	10	900 80 180140 1		1,530	6	250	105	92	10,7	8,3
180-125	10	900 80 180125 1		1,414	6	255	105	87	10,7	7,4
180-110	10	900 80 180110 1		1,350	6	255	105	82	10,7	6,6
200-180	10	900 80 200180 1		2,255	8	275	112	105	11,9	10,7
200-160	10	900 80 200160 1		2,009	8	270	112	98	11,9	9,5
200-140	10	900 80 200140 1		1,990	8	275	112	92	11,9	8,3
200-110	10	900 80 200110 1		1,863	8	275	112	82	11,9	6,6
225-200	10	900 80 225200 1		3,194	5	300	120	112	13,4	11,9
225-180	10	900 80 225180 1		2,835	5	280	120	105	13,4	10,7
225-160	10	900 80 225160 1		2,570	5	280	120	98	13,4	9,5
225-110	10	900 80 225110 1		2,420	4	295	120	82	13,4	6,6
250-225	10	900 80 250225 1		3,995	2	305	129	120	14,8	13,4
250-200	10	900 80 250200 1		3,694	2	310	129	112	14,8	11,9
250-180	10	900 80 250180 1		3,576	2	305	129	105	14,8	10,7
250-160	10	900 80 250160 1		3,017	2	228	129	98	14,8	9,5
280-250	10	900 80 280250 1		5,795	2	348	139	129	16,6	14,8
280-225	10	900 80 280225 1		5,142	2	336	139	120	16,6	13,4
280-200	10	900 80 280200 1		4,894	2	348	139	112	16,6	11,9
280-180	10	900 80 280180 1		4,589	2	348	139	105	16,6	10,7
315-280	10	900 80 315280 1		7,383	2	355	150	139	18,7	16,6
315-250	10	900 80 315250 1		6,856	2	375	150	129	18,7	14,8
315-225	10	900 80 315225 1		6,504	2	375	150	120	18,7	13,4
355-315	10	900 80 355315 1		8,090	1	390	164	150	21,1	18,7
400-315	10	900 80 400315 1		12,376	1	430	179	150	23,7	18,7

PP Kaplı Çelik Flanş
 PP Coated Steel Flange

PE100 SDR11 PN 16

Çap Dia	Basınç PN	Kod Code	Fiyat (Adet) Price (Pcs)	Kg /Adet Kg/Pcs	Koli/Adet Box/Pcs	D (mm)	A (mm)	K (mm)	B (mm)	L (mm)	Civata (mm)	Delik Adedi (mm)
20	16	901 00 020 2		2,323	85	95	28	65	12	14	M12	4
25	16	901 00 025 2		0,288	68	105	34	75	12	14	M12	4
32	16	901 00 032 2		0,544	52	115	42	85	16	14	M12	4
40	16	901 00 040 2		0,836	20	140	51	100	16	18	M16	4
50	16	901 00 050 2		0,902	15	150	62	110	18	18	M16	4
63	16	901 00 063 2		1,074	15	165	78	125	18	18	M16	4
75	16	901 00 075 2		1,368	15	188	92	145	18	18	M16	4
90	16	901 00 090 2		1,516	10	204	108	160	20	18	M16	8
110	16	901 00 110 2		1,960	10	224	128	180	20	18	M16	8
125	16	901 00 125 2		1,938	10	224	135	180	20	18	M16	8
140	16	901 00 140 2		2,866	6	252	158	210	24	18	M16	8
160	16	901 00 160 2		3,576	6	285	178	240	24	22	M20	8
180	16	901 00 180 2		3,298	6	285	188	240	24	22	M20	8
200	16	901 00 200 2		5,032	4	340	235	295	27	22	M20	12
225	16	901 00 225 2		4,900	4	340	238	295	27	22	M20	12
250	16	901 00 250 2		10,182	2	419	288	355	32	26	M24	12
280	16	901 00 280 2		9,860	2	419	294	350	32	26	M24	12
315	16	901 00 315 2		13,150	2	478	338	410	34	26	M24	12
355	16	901 00 355 2		22,200	1	532	376	470	42	26	M24	16
400	16	901 00 400 2		26,214	1	592	430	525	46	30	M27	16

PE100 SDR17 PN 10

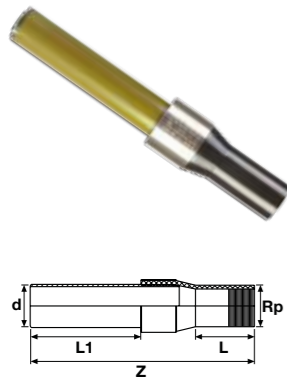
Çap Dia	Basınç PN	Kod Code	Fiyat (Adet) Price (Pcs)	Kg /Adet Kg/Pcs	Koli/Adet Box/Pcs	D (mm)	A (mm)	K (mm)	B (mm)	L (mm)	Civata (mm)	Delik Adedi (mm)
200	10	901 00 200 1		5,318	4	340	235	295	27	22	M20	8
225	10	901 00 225 1		5,500	4	340	238	295	27	22	M20	8
250	10	901 00 250 1		6,962	4	395	288	350	30	22	M20	12
280	10	901 00 280 1		7,092	4	395	294	350	30	22	M20	12
315	10	901 00 315 1		9,428	2	445	338	400	34	22	M20	12
355	10	901 00 355 1		19,285	1	514	376	460	40	22	M20	16
400	10	901 00 400 1		21,370	1	571	430	515	40	26	M24	16

PE Çelik Geçiş Adaptörü Dış Dişli
 PE Steel Transition Adaptor Male Threaded

Çap Dia	Basınç PN	Kod Code	Fiyat (Adet) Price (Pcs)	Kg /Adet Kg/Pcs	Koli/Adet Box/Pcs	L (mm)	L1 (mm)	Z (mm)
20x1/2"	16	901 100 20 2		0,164		45	77	182
25x3/4"	16	901 100 25 2		0,186		47	83	194
32x1"	16	901 100 32 2		0,376		50	96	229
32x3/4"	16			0,236		50	96	229
40x1 1/4"	16	901 100 40 2		0,460		54	101	233
50x1 1/2"	16	901 100 50 2		0,592		54	103	236
63x 2"	16	901 100 63 2		0,910		58	111	253
75x2 1/2"	16	901 100 75 2		1,400		70	135	316
90x3"	16	901 100 90 2		2,000		80	145	343
110x4"	16	901 10 110 2		2,900		85	158	360

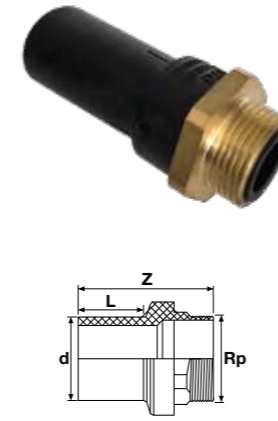
PE Pirinç Metal Geçiş Adaptörü Dış Dişli
 PE Brass Metal Transition Adaptor Male Threaded

Çap Dia	Basınç PN	Kod Code	Fiyat (Adet) Price (Pcs)	Kg /Adet Kg/Pcs	Koli/Ad. Box/Pcs	L (mm)	Z (mm)
20x1/2"	16	901 006 20 2		0,080		45	83
25x1/2"	16			0,086		43	80
25x3/4"	16	901 006 25 2		0,104		45	83
32x3/4"	16			0,118		51	89
32x1"	16	901 006 32 2		0,175		47	96
40x1 1/4"	16	901 006 40 2		0,350		56	118
50x1 1/2"	16	901 006 50 2		0,360		56	119
63x 2"	16	901 006 63 2		0,605		69	137
75x2 1/2"	16	901 006 75 2		0,810		80	155
90x3"	16	901 006 90 2		1,200		83	165
110x4"	16	901 06 110 2		1,810		85	168

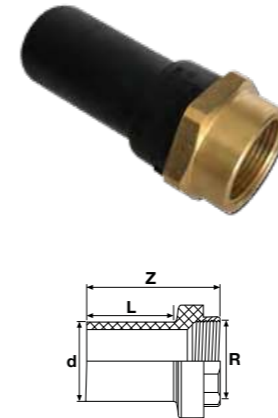
PE Pirinç Metal Geçiş Adaptörü İç Dişli
 PE Brass Metal Transition Adaptor Female Threaded

Çap Dia	Basınç PN	Kod Code	Fiyat (Adet) Price (Pcs)	Kg /Adet Kg/Pcs	Koli/Ad. Box/Pcs	L (mm)	Z (mm)
20x1/2"	16	901 008 20 2		0,050		46	70
25x1/2"	16			0,076		45	71
32x1"	16	901 008 32 2		0,138		47	81
40x1 1/4"	16	901 008 40 2		0,307		56	100
50x1 1/2"	16	901 008 50 2		0,290		68	116
63x 2"	16	901 008 63 2		0,480		68	116
75x2 1/2"	16	901 008 75 2		0,735		75	122
90x3"	16	901 008 90 2		1,175		80	142
110x4"	16	901 08 110 2		1,442		83	138

PE Dış Dişli Adaptör
 PE Male Threaded Adaptor

Çap Dia	Basınç PN	Kod Code	Fiyat (Adet) Price (Pcs)	Kg /Adet Kg/Pcs	Koli/Ad. Box/Pcs	L (mm)	L1 (mm)	Z (mm)
20x1/2"	16	901 007 20 2		0,013		60	17	33
25x3/4"	16	901 007 25 2		0,018		65	18	34
32x1"	16	901 007 32 2		0,032		76	21	42
40x1 1/4"	16	901 007 40 2		0,055		82	23	43
50x1 1/2"	16	901 007 50 2		0,075		98	24	48
63x 2"	16	901 007 63 2		0,140		104	29	55

Not / Note

HDPE

KONFEKSİYON EK PARÇALAR HAND-MADE FITTINGS

ÜRETİM STANDARDI
PRODUCTION STANDARD | TS EN 12201-3 +A1

ÇAP / SIZE Ø75 - Ø630



 **PIMTAŞ**[®]

Since 1977

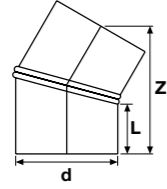
11° Dirsek (Konfeksiyon)
 11° Elbow (Hand-made)

PE100 SDR11

Çap Dia	Basınç PN	Kod Code	Fiyat (Adet) Price (Pcs)	Kg /Adet Kg/Pcs	Koli/Adet Box/Pcs	L (mm)	Z (mm)
90	16	905 0 090 2		0,528	24	120	129
110	16	905 0 110 2		0,977	18	150	161
125	16	905 0 125 2		1,273	12	150	162
140	16	905 0 140 2		1,590	12	150	163
160	16	905 0 160 2		2,101	9	150	165
180	16	905 0 180 2		2,669	4	150	167
200	16	905 0 200 2		3,318	4	150	169
225	16	905 0 225 2		4,218	2	150	172
250	16	905 0 250 2		6,869	2	200	224
280	16	905 0 280 2		8,668	1	200	227
315	16	905 0 315 2		11,008	1	200	230
355	16	905 0 355 2		16,705	1	240	274
400	16	905 0 400 2		21,435	1	240	279

PE100 SDR17

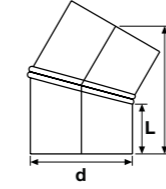
Çap Dia	Basınç PN	Kod Code	Fiyat (Adet) Price (Pcs)	Kg /Adet Kg/Pcs	Koli/Adet Box/Pcs	L (mm)	Z (mm)
90	10	905 0 090 1		0,364	24	120	129
110	10	905 0 110 1		0,675	18	150	161
125	10	905 0 125 1		0,861	12	150	162
140	10	905 0 140 1		1,083	12	150	163
160	10	905 0 160 1		1,424	9	150	165
180	10	905 0 180 1		1,810	4	150	167
200	10	905 0 200 1		2,249	4	150	169
225	10	905 0 225 1		2,875	2	150	172
250	10	905 0 250 1		4,664	2	200	224
280	10	905 0 280 1		5,850	1	200	227
315	10	905 0 315 1		7,482	1	200	230
355	10	905 0 355 1		11,359	1	240	274
400	10	905 0 400 1		14,532	1	240	279

30° Dirsek (Konfeksiyon)
 30° Elbow (Hand-made)

PE100 SDR11

Çap Dia	Basınç PN	Kod Code	Fiyat (Adet) Price (Pcs)	Kg /Adet Kg/Pcs	Koli/Adet Box/Pcs	L (mm)	Z (mm)
75	16	907 0 075 2		0,323		100	120
90	16	907 0 090 2		0,475	24	100	124
110	16	907 0 110 2		1,033	18	150	179
125	16	907 0 125 2		1,359	12	150	183
140	16	907 0 140 2		1,717	12	150	188
160	16	907 0 160 2		2,288	9	150	193
180	16	907 0 180 2		2,930	4	150	198
200	16	907 0 200 2		3,682	4	150	204
225	16	907 0 225 2		4,716	2	150	210
250	16	907 0 250 2		7,565	2	200	267
280	16	907 0 280 2		9,643	1	200	275
315	16	907 0 315 2		12,390	1	200	284
355	16	907 0 355 2		18,688	1	240	335
400	16	907 0 400 2		24,243	1	240	347

PE100 SDR17

Çap Dia	Basınç PN	Kod Code	Fiyat (Adet) Price (Pcs)	Kg /Adet Kg/Pcs	Koli/Adet Box/Pcs	L (mm)	Z (mm)
75	10	907 0 075 1		0,224		100	120
90	10	907 0 090 1		0,327	24	100	124
110	10	907 0 110 1		0,714	18	150	179
125	10	907 0 125 1		0,919	12	150	183
140	10	907 0 140 1		1,169	12	150	188
160	10	907 0 160 1		1,550	9	150	193
180	10	907 0 180 1		1,987	4	150	198
200	10	907 0 200 1		2,496	4	150	204
225	10	907 0 225 1		3,215	2	150	210
250	10	907 0 250 1		5,137	2	200	267
280	10	907 0 280 1		6,508	1	200	275
315	10	907 0 315 1		8,422	1	200	284
355	10	907 0 355 1		12,708	1	240	335
400	10	907 0 400 1		16,436	1	240	347

45° Dirsek (Konfeksiyon)
 45° Elbow (Hand-made)

PE100 SDR11

Çap Dia	Basınç PN	Kod Code	Fiyat (Adet) Price (Pcs)	Kg /Adet Kg/Pcs	Koli/Adet Box/Pcs	L (mm)	Z (mm)
710	16	908 0 710 2		130,260	24	240	495
800	16	908 0 800 2		177,288	18	250	524
900	16	908 0 900 2		264,180	12	300	545

PE100 SDR17

Çap Dia	Basınç PN	Kod Code	Fiyat (Adet) Price (Pcs)	Kg /Adet Kg/Pcs	Koli/Adet Box/Pcs	L (mm)	Z (mm)
710	10	908 0 710 1		88,176	24	240	495
800	10	908 0 800 1		119,616	18	250	524
900	10	908 0 900 1		177,378	12	300	545
1000	10	908 1 000 1		227,150	12	300	642
1200	10	908 1 200 1		439,636	9	300	684
1400	10	908 1 400 1		605,820	4	400	933
1600	10	908 1 600 1		831,708	4	400	975

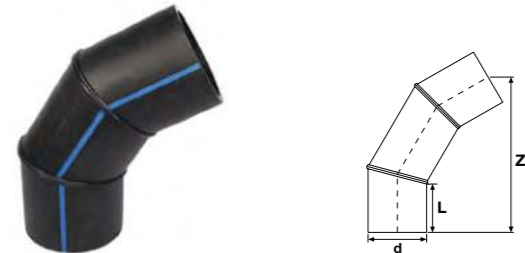
60° Dirsek (Konfeksiyon)
 60° Elbow (Hand-made)

PE100 SDR11

Çap Dia	Basınç PN	Kod Code	Fiyat (Adet) Price (Pcs)	Kg /Adet Kg/Pcs	Koli/Adet Box/Pcs	L (mm)	Z (mm)
710	16	909 0 710 2		143,000	24	240	560
800	16	909 0 800 2		195,548	18	250	596
900	16	909 0 900 2		290,220	12	250	625

PE100 SDR17

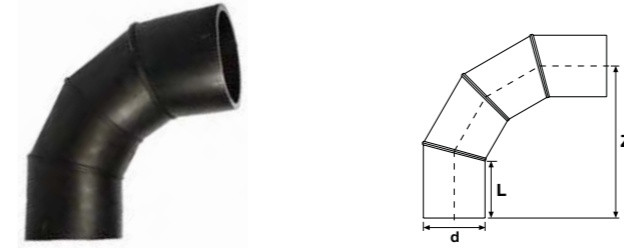
Çap Dia	Basınç PN	Kod Code	Fiyat (Adet) Price (Pcs)	Kg /Adet Kg/Pcs	Koli/Adet Box/Pcs	L (mm)	Z (mm)
710	10	909 0 710 1		96,800	24	240	560
800	10	909 0 800 1		131,936	18	250	596
900	10	909 0 900 1		194,862	12	250	625
1000	10	909 0 1000 1		251,300	12	300	733
1200	10	909 0 1200 1		483,128	9	300	791
1400	10	909 0 1400 1		672,750	4	400	1064
1600	10	909 0 1600 1		932,274	4	400	1122

90° Dirsek (Konfeksiyon)
 90° Elbow (Hand-made)

PE100 SDR11

Çap Dia	Basınç PN	Kod Code	Fiyat (Adet) Price (Pcs)	Kg /Adet Kg/Pcs	Koli/Adet Box/Pcs	L (mm)	Z (mm)
710	16	910 0 710 2		198,900	24	240	868
800	16	910 0 800 2		272,572	18	250	923
900	16	910 0 900 2		403,830	12	250	973

PE100 SDR17

Çap Dia	Basınç PN	Kod Code	Fiyat (Adet) Price (Pcs)	Kg /Adet Kg/Pcs	Koli/Adet Box/Pcs	L (mm)	Z (mm)
710	10	910 0 710 1		134,640	24	240	868
800	10	910 0 800 1		183,904	18	250	923
900	10	910 0 900 1		271,143	12	250	973
1000	10	910 0 1000 1		350,700	12	300	1142
1200	10	910 0 1200 1		672,292	9	300	1142
1400	10	910 0 1400 1		940,125	4	400	1142
1600	10	910 0 1600 1		1.307,811	4	400	1142

Eşit TE (Konfeksiyon)
 Equal TEE (Hand-made)

PE100 SDR11

Çap Dia	Basınç PN	Kod Code	Fiyat (Adet) Price (Pcs)	Kg /Adet Kg/Pcs	Koli/Adet Box/Pcs	L (mm)	L1 (mm)	Z (mm)
560	16	911 0 560 2		94,270		1060	250	530
710	16	911 0 710 2		166,178	24	1210	250	605
800	16	911 0 800 2		223,544	18	1300	250	650
900	16	911 0 900 2		329,923	12	1500	300	750

PE100 SDR17

Çap Dia	Basınç PN	Kod Code	Fiyat (Adet) Price (Pcs)	Kg /Adet Kg/Pcs	Koli/Adet Box/Pcs	L (mm)	L1 (mm)	Z (mm)
710	10	911 0 710 1		113,062	24	1210	250	605
800	10	911 0 800 1		151,561	18	1300	250	650
900	10	911 0 900 1		222,435	12	1500	300	750
1000	10	911 0 1000 1		315,669	12	1700	350	850
1200	10	911 0 1200 1		515,119	9	1900	350	950
1400	10	911 0 1400 1		830,564	4	2300	450	1150
1600	10	911 0 1600 1		1.252,127	4	2600	550	1350

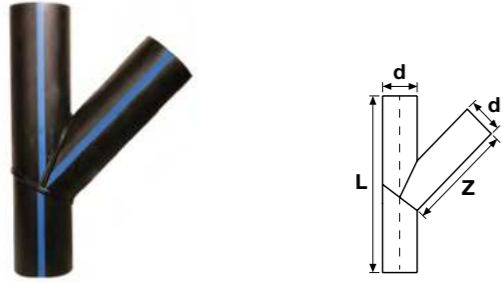
45° Çatal Te (Konfeksiyon)
 45° Elbow Tee (Hand-made)

PE100 SDR11

Çap Dia	Basınç PN	Kod Code	Fiyat (Adet) Price (Pcs)	Kg /Adet Kg/Pcs	Koli/Adet Box/Pcs	L (mm)	Z (mm)
90	16	912 00 90 2		1,693		556	333
125	16	912 0 125 2		3,272		577	351
140	16	912 0 140 2		4,195		598	369
180	16	912 0 180 2		7,496		655	417
200	16	912 0 200 2		11,152		783	491
225	16	912 0 225 2		14,572		818	522
250	16	912 0 250 2		21,121		954	602
280	16	912 0 280 2		27,435		996	638
315	16	912 0 315 2		39,845		1145	730
355	16	912 0 355 2		52,718		1202	779
400	16	912 0 400 2		69,990		1266	833
450	16	912 0 450 2		92,775		1336	893
500	16	912 0 500 2		119,668		1407	954
560	16	912 0 560 2		157,683		1492	1026
630	16	912 0 630 2		210,385		1591	1110

PE100 SDR17

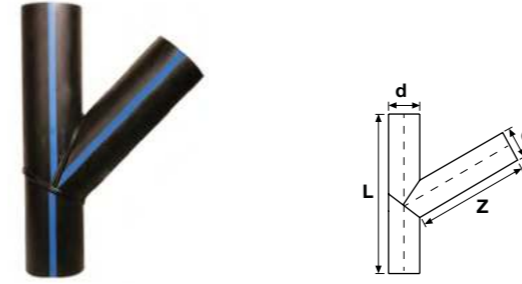
Çap Dia	Basınç PN	Kod Code	Fiyat (Adet) Price (Pcs)	Kg /Adet Kg/Pcs	Koli/Adet Box/Pcs	L (mm)	Z (mm)
90	16	912 00 90 1		1,169		556	333
125	16	912 0 125 1		2,221		577	351
140	16	912 0 140 1		2,867		598	369
180	16	912 0 180 1		5,103		655	417
200	16	912 0 200 1		7,585		783	491
225	16	912 0 225 1		9,976		818	522
250	16	912 0 250 1		14,397		954	602
280	16	912 0 280 1		18,577		996	638
315	16	912 0 315 1		27,188		1145	730
355	16	912 0 355 1		35,994		1202	779
400	16	912 0 400 1		47,662		1266	833
450	16	912 0 450 1		63,086		1336	893
500	16	912 0 500 1		81,673		1407	954
560	16	912 0 560 1		107,515		1492	1026
630	16	912 0 630 1		144,020		1591	1110

60° Çatal Te (Konfeksiyon)
 60° Elbow Tee (Hand-made)

PE100 SDR11

Çap Dia	Basınç PN	Kod Code	Fiyat (Adet) Price (Pcs)	Kg /Adet Kg/Pcs	Koli/Adet Box/Pcs	L (mm)	Z (mm)
90	16	914 00 90 2		1,623		527	295
110	16	914 0 110 2		2,364		527	295
125	16	914 0 125 2		3,156		544	308
140	16	914 0 140 2		4,039		562	321
160	16	914 0 160 2		5,493		585	339
180	16	914 0 180 2		7,165		608	356
200	16	914 0 200 2		10,696		731	423
225	16	914 0 225 2		13,929		760	445
250	16	914 0 250 2		20,234		889	517
280	16	914 0 280 2		26,190		923	543
315	16	914 0 315 2		38,110		1064	623
355	16	914 0 355 2		50,199		1110	658
400	16	914 0 400 2		66,382		1162	697
450	16	914 0 450 2		87,691		1220	740
500	16	914 0 500 2		112,566		1277	783
560	16	914 0 560 2		147,812		1347	835
630	16	914 0 630 2		196,405		1427	896

PE100 SDR17

Çap Dia	Basınç PN	Kod Code	Fiyat (Adet) Price (Pcs)	Kg /Adet Kg/Pcs	Koli/Adet Box/Pcs	L (mm)	Z (mm)
90	10	914 00 90 1		1,120		527	295
110	10	914 0 110 1		1,637		527	295
125	10	914 0 125 1		2,140		544	308
140	10	914 0 140 1		2,758		562	321
160	10	914 0 160 1		3,732		585	339
180	10	914 0 180 1		4,872		608	356
200	10	914 0 200 1		7,268		731	423
225	10	914 0 225 1		9,524		760	445
250	10	914 0 250 1		13,776		889	517
280	10	914 0 280 1		17,716		923	543
315	10	914 0 315 1		25,974		1064	623
355	10	914 0 355 1		34,232		1110	658
400	10	914 0 400 1		45,146		1162	697
450	10	914 0 450 1		59,548		1220	740
500	10	914 0 500 1		76,714		1277	783
560	10	914 0 560 1		100,630		1347	835
630	10	914 0 630 1		134,216		1427	896

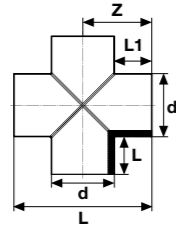
İstavroz Te 90° (Konfeksiyon)
90° Cross Tee (Hand-made)



PE100 SDR11

Çap Dia	Basınç PN	Kod Code	Fiyat (Adet) Price (Pcs)	Kg /Adet Kg/Pcs	Koli/Adet Box/Pcs	L (mm)	Z (mm)	I (mm)	I1 (mm)
75	16	915 0 075 2		0,584		255	127	90	90
90	16	915 0 090 2		0,857		270	135	90	90
125	16	915 0 125 2		2,206		364	182	120	120
140	16	915 0 140 2		2,991		400	200	130	130
180	16	915 0 180 2		5,796		480	240	150	150
200	16	915 0 200 2		7,255		500	250	150	150
225	16	915 0 225 2		9,286		524	262	150	150
250	16	915 0 250 2		11,709		550	275	150	150
280	16	915 0 280 2		14,971		580	290	150	150
315	16	915 0 315 2		19,275		614	307	150	150
355	16	915 0 355 2		31,609		754	377	200	200
400	16	915 0 400 2		41,121		800	400	200	200
450	16	915 0 450 2		53,341		850	425	200	200
500	16	915 0 500 2		67,359		900	450	200	200
560	16	915 0 560 2		102,901		1060	530	250	250
630	16	915 0 630 2		133,273		1130	565	250	250

PE100 SDR17

Çap Dia	Basınç PN	Kod Code	Fiyat (Adet) Price (Pcs)	Kg /Adet Kg/Pcs	Koli/Adet Box/Pcs	L (mm)	Z (mm)	I (mm)	I1 (mm)
75	10	915 0 075 1		0,407		255	127	90	90
90	10	915 0 090 1		0,593		270	135	90	90
125	10	915 0 125 1		1,499		364	182	120	120
140	10	915 0 140 1		2,047		400	200	130	130
180	10	915 0 180 1		3,950		480	240	150	150
200	10	915 0 200 1		4,948		500	250	150	150
225	10	915 0 225 1		6,373		524	262	150	150
250	10	915 0 250 1		8,006		550	275	150	150
280	10	915 0 280 1		10,165		580	290	150	150
315	10	915 0 315 1		13,208		614	307	150	150
355	10	915 0 355 1		21,640		754	377	200	200
400	10	915 0 400 1		28,090		800	400	200	200
450	10	915 0 450 1		36,394		850	425	200	200
500	10	915 0 500 1		46,152		900	450	200	200
560	10	915 0 560 1		70,360		1060	530	250	250
630	10	915 0 630 1		91,554		1130	565	250	250

İnegal TE (Konfeksiyon)
Reducer Tee (Hand-made)

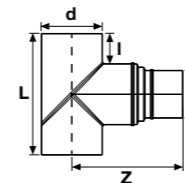
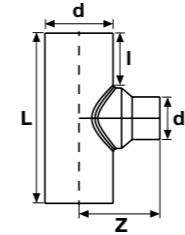

PE100 SDR11

Çap Dia	Basınç PN	Kod Code	Tip Type	Fiyat (Adet) Price (Pcs)	I (mm)	Z (mm)	L (mm)
355-315	16	916 0 355315 2	B		273	660,5	901
355-280	16	916 0 355280 2	B		273	780,5	901
355-250	16	916 0 355250 2	B		273	780,5	901
355-225	16	916 0 355225 2	B		273	780,5	901
355-200	16	916 0 355200 2	B		273	900,5	901
355-180	16	916 0 355180 2	B		273	900,5	901
355-160	16	916 0 355160 2	A		184	331	568
355-140	16	916 0 355140 2	A		184	325	568
355-125	16	916 0 355125 2	A		184	320	568
355-110	16	916 0 355110 2	A		184	315	548
355-90	16	916 0 35590 2	A		184	312	528
400-355	16	916 0 400355 2	B		290	720	980
400-315	16	916 0 400315 2	B		290	740	980
400-280	16	916 0 400280 2	B		290	860	980
400-250	16	916 0 400250 2	B		290	860	980
400-225	16	916 0 400225 2	B		290	860	980
400-200	16	916 0 400200 2	B		290	980	980
400-180	16	916 0 400180 2	A		199	360	623
400-160	16	916 0 400160 2	A		199	353	623
400-140	16	916 0 400140 2	A		199	347	623
400-125	16	916 0 400125 2	A		199	342	598
400-110	16	916 0 400110 2	A		199	337	578
400-90	16	916 0 40090 2	A		199	334	578
400-63	16	916 0 40063 2					
450-400	16	916 0 450400 2	B		305	780	1060
450-355	16	916 0 450355 2	B		305	810	1060
450-315	16	916 0 450315 2	B		305	830	1060
450-280	16	916 0 450280 2	B		305	950	1060
450-250	16	916 0 450250 2	B		305	950	1060
450-225	16	916 0 450225 2	B		305	950	1060
450-200	16	916 0 450200 2	A		215	392	680
450-180	16	916 0 450180 2	A		215	385	680
450-160	16	916 0 450160 2	A		215	378	680
450-140	16	916 0 450140 2	A		215	372	655
450-125	16	916 0 450125 2	A		215	367	630
450-110	16	916 0 450110 2	A		215	362	630
450-90	16	916 0 45090 2	A		215	359	610
500-450	16	916 0 500450 2	B		330	840	1160
500-400	16	916 0 500400 2	B		330	900	1160
500-355	16	916 0 500355 2	B		330	930	1160
500-315	16	916 0 500315 2	B		330	950	1160
500-280	16	916 0 500280 2	B		330	1070	1160
500-250	16	916 0 500250 2	B		330	1070	1160
500-225	16	916 0 500225 2	A		232	425	744
500-200	16	916 0 500200 2	A		232	417	744
500-180	16	916 0 500180 2	A		232	410	744
500-160	16	916 0 500160 2	A		232	403	714
500-140	16	916 0 500140 2	A		232	397	689
500-125	16	916 0 500125 2	A		232	392	689
500-110	16	916 0 500110 2	A		232	387	664
500-90	16	916 0 50090 2	A		232	384	664

İnegal TE (Konfeksiyon)
Reducer Tee (Hand-made)

PE100 SDR17

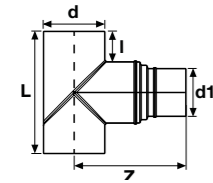
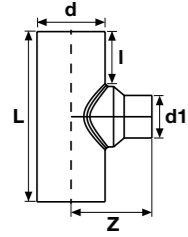

Çap Dia	Basınç PN	Kod Code	Tip Type	Fiyat (Adet) Price (Pcs)	I (mm)	Z (mm)	L (mm)
355-315	16	916 0 355315 1	B		273	660,5	901
355-280	16	916 0 355280 1	B		273	780,5	901
355-250	16	916 0 355250 1	B		273	780,5	901
355-225	16	916 0 355225 1	B		273	780,5	901
355-200	16	916 0 355200 1	B		273	900,5	901
355-180	16	916 0 355180 1	A		273	338	568
355-160	16	916 0 355160 1	A		184	331	568
355-140	16	916 0 355140 1	A		184	325	548
355-125	16	916 0 355125 1	A		184	320	528
355-110	16	916 0 355110 1	A		184	315	528
355-90	16	916 0 35590 1	A		184	312	508
400-355	16	916 0 400355 1	B		290	720	980
400-315	16	916 0 400315 1	B		290	740	980
400-280	16	916 0 400280 1	B		290	860	980
400-250	16	916 0 400250 1	B		290	860	980
400-225	16	916 0 400225 1	B		290	860	980
400-200	16	916 0 400200 1	A		199	367	623
400-180	16	916 0 400180 1	A		199	360	623
400-160	16	916 0 400160 1	A		199	353	598
400-140	16	916 0 400140 1	A		199	347	578
400-125	16	916 0 400125 1	A		199	342	578
400-110	16	916 0 400110 1	A		199	337	558
400-90	16	916 0 40090 1	A		199	334	538
400-63	16	916 0 40063 1	A		199	334	538
450-400	16	916 0 450400 1	B		305	780	1060
450-355	16	916 0 450355 1	B		305	810	1060
450-315	16	916 0 450315 1	B		305	830	1060
450-280	16	916 0 450280 1	B		305	950	1060
450-250	16	916 0 450250 1	B		305	950	1060
450-225	16	916 0 450225 1	A		205	400	680
450-200	16	916 0 450200 1	A		215	392	680
450-180	16	916 0 450180 1	A		215	385	655
450-160	16	916 0 450160 1	A		215	378	630
450-140	16	916 0 450140 1	A		215	372	630
450-125	16	916 0 450125 1	A		215	367	610
450-110	16	916 0 450110 1	A		215	362	590
450-90	16	916 0 45090 1	A		215	359	590
500-450	16	916 0 500450 1	B		330	840	1160
500-400	16	916 0 500400 1	B		330	900	1160
500-355	16	916 0 500355 1	B		330	930	1160
500-315	16	916 0 500315 1	B		330	950	1160
500-280	16	916 0 500280 1	B		330	1070	1160
500-250	16	916 0 500250 1	A		232	434	744
500-225	16	916 0 500225 1	A		232	425	744
500-200	16	916 0 500200 1	A		232	417	714
500-180	16	916 0 500180 1	A		232	410	689
500-160	16	916 0 500160 1	A		232	403	689
500-140	16	916 0 500140 1	A		232	397	664
500-125	16	916 0 500125 1	A		232	392	644
500-110	16	916 0 500110 1	A		232	387	644
500-90	16	916 0 50090 1	A		232	384	624

PP-B

KAPLIN VANALAR COMPRESSION VALVES

ÜRETİM STANDARTI
PRODUCTION STANDARD | TS ISO 17885

ÇAP / SIZE Ø20 - Ø110



PP Çift Tarafı Dişi Çıkışlı Single Vana
PP Both Sides Female Threaded Single Union Ball Valve

YENİ / NEW

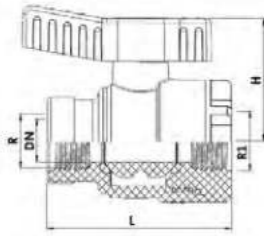

Çap Dia	Rp (Inch)	Basınç Pn	Kod Code	Fiyat (Adet) Price (Pcs)
1/2"	1/2"	16	EX234 000 20 2	
3/4"	3/4"	16	EX234 000 25 2	
3/4"	1"	16	EX234 000 25 3	
1"	3/4"	16	EX234 000 32 2	
1"	1"	16	EX234 000 32 3	
1"	1 1/4"	16	EX234 000 32 4	
1 1/4"	1"	16	EX234 000 40 2	
1 1/4"	1 1/4"	16	EX234 000 40 3	
1 1/4"	1 1/2"	16	EX234 000 40 4	
1 1/2"	1 1/4"	16	EX234 000 50 2	
1 1/2"	1 1/2"	16	EX234 000 50 3	
1 1/2"	2"	16	EX234 000 50 4	
2"	1 1/2"	16	EX234 000 63 2	
2"	2"	16	EX234 000 63 3	
2"	2 1/2"	16	EX234 000 63 4	
2 1/2"	2"	16	EX234 000 75 2	
2 1/2"	2 1/2"	16	EX234 000 75 3	
2 1/2"	3"	16	EX234 000 75 4	
3"	2 1/2"	16	EX234 000 90 2	
3"	3"	16	EX234 000 90 3	
3"	4"	16	EX234 000 90 4	
4"	3"	16	EX234 000 110 2	
4"	4"	16	EX234 000 110 3	

PP Tek Tarafı Erkek Tek Tarafı Dişi Çıkışlı Single Vana
PP One Side Male Threaded One Side Female Threaded Single Union Ball Valve

YENİ / NEW

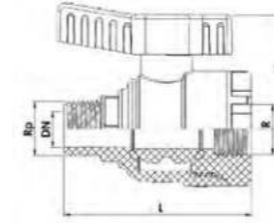

Çap Dia	Rp (Inch)	Basınç Pn	Kod Code	Fiyat (Adet) Price (Pcs)
1/2"	1/2"	16	EX234 100 20 2	
3/4"	3/4"	16	EX234 100 25 2	
3/4"	1"	16	EX234 100 25 3	
1"	3/4"	16	EX234 100 32 2	
1"	1"	16	EX234 100 32 3	
1"	1 1/4"	16	EX234 100 32 4	
1 1/4"	1"	16	EX234 100 40 2	
1 1/4"	1 1/4"	16	EX234 100 40 3	
1 1/4"	1 1/2"	16	EX234 100 40 4	
1 1/2"	1 1/4"	16	EX234 100 50 2	
1 1/2"	1 1/2"	16	EX234 100 50 3	
1 1/2"	2"	16	EX234 100 50 4	
2"	1 1/2"	16	EX234 100 63 2	
2"	2"	16	EX234 100 63 3	
2"	2 1/2"	16	EX234 100 63 4	
2 1/2"	2"	16	EX234 100 75 2	
2 1/2"	2 1/2"	16	EX234 100 75 3	
2 1/2"	3"	16	EX234 100 75 4	
3"	2 1/2"	16	EX234 100 90 2	
3"	3"	16	EX234 100 90 3	
3"	4"	16	EX234 100 90 4	
4"	3"	16	EX234 100 110 2	
4"	4"	16	EX234 100 110 3	

PP Tek Tarafı Dişi Tek Tarafı Kaplin Çıkışlı Single Vana
PP One Side Female Threaded One Side Compression Outlet Single Union Ball Valve

YENİ / NEW

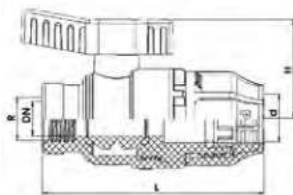

Çap Dia	Rp (Inch)	Basınç Pn	Kod Code	Fiyat (Adet) Price (Pcs)
20	1/2"	16	EX234 200 20 2	
25	3/4"	16	EX234 200 25 2	
32	1"	16	EX234 200 32 2	
40	1"	16	EX234 200 40 2	
40	1 1/4"	16	EX234 200 40 3	
50	1 1/4"	16	EX234 200 50 2	
50	1 1/2"	16	EX234 200 50 3	
63	2"	16	EX234 200 63 2	
75	2 1/2"	16	EX234 200 75 2	
90	3"	16	EX234 200 90 2	
110	4"	16	EX234 200 110 2	

PP Tek Tarafı Erkek Tek Tarafı Kaplin Çıkışlı Single Vana
PP One Side Male Threaded One Side Compression Outlet Single Union Ball Valve

YENİ / NEW

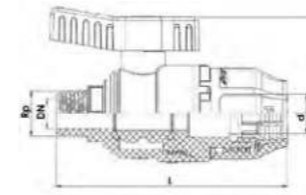

Çap Dia	Rp (Inch)	Basınç Pn	Kod Code	Fiyat (Adet) Price (Pcs)
20	1/2"	16	EX234 300 20 2	
25	3/4"	16	EX234 300 25 2	
32	1"	16	EX234 300 32 2	
40	1"	16	EX234 300 40 2	
40	1 1/4"	16	EX234 300 40 3	
50	1 1/4"	16	EX234 300 50 2	
50	1 1/2"	16	EX234 300 50 3	
63	2"	16	EX234 300 63 2	
75	2 1/2"	16	EX234 300 75 2	
90	3"	16	EX234 300 90 2	
110	4"	16	EX234 300 110 2	

PP Tek Tarafı Kaplin Tek Tarafı Dişi Çıkışlı Single Vana

PP One Side Compression Outlet One Side Female Threaded Single Union Ball Valve

YENİ / NEW

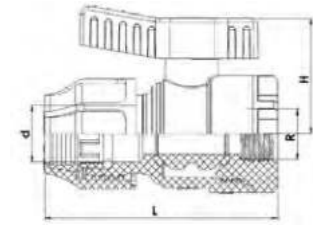

Çap Dia	Rp (Inch)	Basınç Pn	Kod Code	Fiyat (Adet) Price (Pcs)
20	1/2"	16	EX234 400 20 2	
25	3/4"	16	EX234 400 25 2	
25	1"	16	EX234 400 25 3	
32	3/4"	16	EX234 400 32 2	
32	1"	16	EX234 400 32 3	
32	1 1/4"	16	EX234 400 32 4	
40	1"	16	EX234 400 40 2	
40	1 1/4"	16	EX234 400 40 3	
40	1 1/2"	16	EX234 400 40 4	
50	1 1/4"	16	EX234 400 50 2	
50	1 1/2"	16	EX234 400 50 3	
50	2"	16	EX234 400 50 4	
63	1 1/2"	16	EX234 400 63 2	
63	2"	16	EX234 400 63 3	
63	2 1/2"	16	EX234 400 63 4	
75	2"	16	EX234 400 75 2	
75	2 1/2"	16	EX234 400 75 3	
75	3"	16	EX234 400 75 4	
90	2 1/2"	16	EX234 400 90 2	
90	3"	16	EX234 400 90 3	
90	4"	16	EX234 400 90 4	
110	3"	16	EX234 400 110 2	
110	4"	16	EX234 400 110 3	

PP Çift Tarafı Kaplin Çıkışlı Single Vana

PP Both Sides Compression Outlet Single Union Ball Valve

YENİ / NEW

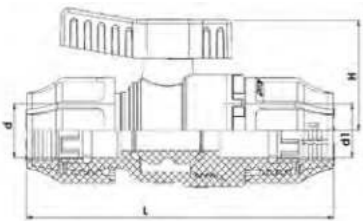

Çap Dia	Rp (Inch)	Basınç Pn	Kod Code	Fiyat (Adet) Price (Pcs)
20	20	16	EX234 500 20 2	
25	25	16	EX234 500 25 2	
32	32	16	EX234 500 32 2	
32	40	16	EX234 500 32 3	
40	40	16	EX234 500 40 2	
40	50	16	EX234 500 40 3	
50	50	16	EX234 500 50 2	
63	63	16	EX234 500 63 2	
75	75	16	EX234 500 75 2	
90	90	16	EX234 500 90 2	
110	110	16	EX234 500 110 2	

U-PVC Küresel Tek Tarafı Vana Çift Taraf Kaplin Çıkışlı

U-PVC Single Union Ball Valve Both Sides Compression Outlet

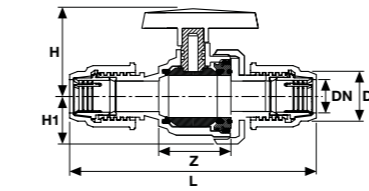

Çap Dia	Basınç Pn	Kod Code	Fiyat (Adet) Price (Pcs)	Koli Adet Box Pcs	DN (mm)	Z (mm)	L (mm)	H (mm)	H1 (mm)
20	16	EX233 300 20 2		90	15	52	129	47	27
25	16	EX233 300 25 2		60	20	58	140	51	31
32	16	EX233 300 32 2		45	25	61	150	63	33
40	16	EX233 300 40 2		30	32	73	175	67	42
50	16	EX233 300 50 2		15	40	82	200	86	46
63	16	EX233 300 63 2		12	50	95	224	101	58
75	16	EX233 300 75 2		6	65	118	255	110	64
90	16	EX233 300 90 2		2	80	139	292	137	90
110	16	EX233 30 110 2		2	100	165	340	150	106

U-PVC Küresel Tek Taraf İçten Dişli Tek Taraf Kaplin Çıkışlı Tek Tarafı Vana

U-PVC One Side Female Threaded One Side Compression Outlet Single Union Ball Valve

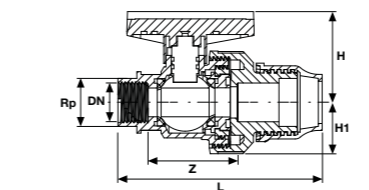

Çap Dia	Rp (Inch)	Basınç Pn	Kod Code	Fiyat (Adet) Price (Pcs)	Koli Adet Box Pcs	DN (mm)	Z (mm)	L (mm)	H (mm)	H1 (mm)
20	1/2"	16	EX233 100 20 2		55	15	52	104	47	27
25	3/4"	16	EX233 100 25 2		75	20	58	108	51	31
32	1"	16	EX233 100 32 2		60	25	61	120	63	33
40	1 1/4"	16	EX233 100 40 2		30	32	73	158	67	42
50	1 1/2"	16	EX233 100 50 2		24	40	82	175	86	46
63	2"	16	EX233 100 63 2		12	50	95	190	101	58
75	2 1/2"	16	EX233 100 75 2		6	65	118	225	110	64
90	3"	16	EX233 100 90 2		4	80	139	260	137	90
110	4"	16	EX233 10 110 2		2	100	165	305	150	106

U-PVC Küresel Tek Taraf Dıştan Dişli Tek Taraf Kaplin Çıkışlı Tek Tarafı Vana

U-PVC One Side Male Threaded One Side Compression Outlet Single Union Ball Valve

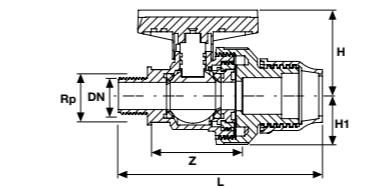

Çap Dia	Rp (Inch)	Basınç Pn	Kod Code	Fiyat (Adet) Price (Pcs)	Koli Adet Box Pcs	DN (mm)	Z (mm)	L (mm)	H (mm)	H1 (mm)
20	1/2"	16	EX233 200 20 2		55	15	52	116	47	27
25	3/4"	16	EX233 200 25 2		60	20	58	125	51	31
32	1"	16	EX233 200 32 2		60	25	61	135	63	33
40	1 1/4"	16	EX233 200 40 2		30	32	73	160	67	42
50	1 1/2"	16	EX233 200 50 2		24	40	82	185	86	46
63	2"	16	EX233 200 63 2		12	50	95	210	101	58
75	2 1/2"	16	EX233 200 75 2		9	65	118	230	110	64
90	3"	16	EX233 200 90 2		4	80	139	270	137	90
110	4"	16	EX233 20 110 2		2	100	165	305	150	106

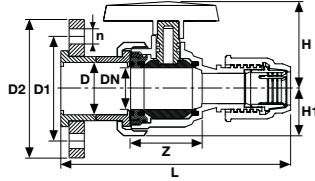
U-PVC Tek Taraf Flanş Bağlantılı Tek Taraf Kaplin Çıkışlı Tek Taraflı Küresel Vana
 U-PVC Solvent Cement Single Union Ball Valve One Side Flanged

Çap Dia	Basınç Pn	Kod Code	Fiyat (Adet) Price (Pcs)	Koli Adet Box Pcs	DN (mm)	Z (mm)	L (mm)	H (mm)	H1 (mm)	D1 (mm)	D2 (mm)	n (mm)
20	16	EX233 017 020 2		64	15	52	133	47	27	65	96	14x4
25	16	EX233 017 025 2		56	20	58	150	51	31	75	105	14x4
32	16	EX233 017 032 2		36	25	61	169	63	33	85	115	14x4
40	16	EX233 017 040 2		30	32	73	195	67	42	100	140	14x4
50	16	EX233 017 050 2		20	40	82	228	86	46	100	150	18x4
63	16	EX233 017 063 2		20	50	95	251	101	58	125	165	18x4
75	16	EX233 017 075 2		8	65	118	292	110	64	145	185	22x4
90	16	EX233 017 090 2		4	80	139	356	137	90	160	200	22x8
110	16	EX233 017 110 2		2	100	165	425	150	106	180	220	24x8

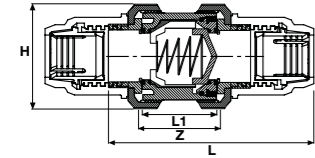
U-PVC Çift Taraf Kaplin Çıkışlı Yaylı Çekvalf
 U-PVC Compression Outlet Spring Checkvalve

Çap Dia	Basınç Pn	Kod Code	Fiyat (Adet) Price (Pcs)	Koli Adet Box Pcs	DN (mm)	Z (mm)	L (mm)	H (mm)
20	16	EX214 01 020 2		60	16	52	150	54
25	16	EX214 01 025 2		75	20	58	165	62
32	16	EX214 01 032 2		60	25	61	182	66
40	16	EX214 01 040 2		32	32	73	205	84
50	16	EX214 01 050 2		20	40	82	240	92
63	16	EX214 01 063 2		8	50	95	275	116
75	16	EX214 01 075 2		9	65	118	310	146
90	16	EX214 01 090 2		4	80	139	360	178
110	16	EX214 01 110 2		2	100	165	420	210

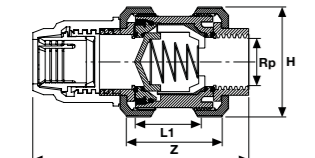
U-PVC Tek Taraf İçten Dişli Tek Taraf Kaplin Çıkışlı Yaylı Çekvalf
 U-PVC One Side Female Threaded One Side Compression Outlet Spring Checkvalve

Çap Dia	Rp (Inch)	Basınç Pn	Kod Code	Fiyat (Adet) Price (Pcs)	Koli Adet Box Pcs	DN (mm)	Z (mm)	L (mm)	H (mm)
20	1/2"	16	EX215 01 020 2		60	16	52	104	54
25	3/4"	16	EX215 01 025 2		75	20	58	108	62
32	1"	16	EX215 01 032 2		60	25	61	120	66
40	1 1/4"	16	EX215 01 040 2		32	32	73	158	84
50	1 1/2"	16	EX215 01 050 2		20	40	82	175	92
63	2"	16	EX215 01 063 2		13	50	95	190	116
75	2 1/2"	16	EX215 01 075 2		9	65	118	225	146
90	3"	16	EX215 01 090 2		4	80	139	260	178
110	4"	16	EX215 01 110 2		2	100	165	305	210

PP-B

 MAVİ SERİ
 BLUE SERIES
 PN 16

KAPLIN EK PARÇALAR

COMPRESSION FITTINGS

 ÜRETİM STANDARTI
 PRODUCTION STANDARD | TS ISO 17885

ÇAP / SIZE Ø20 - Ø110



Kaplin Dişi Adaptör
Female Adaptor

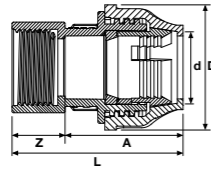

Çap Dia	Basınç Pn	Kod Code	Fiyat (Adet) Price (Pcs)	Koli Adet Box Pcs	Poşet İçi Adet Bag Pcs	D (mm)	A (mm)	Z (mm)	L (mm)
20x1/2"	16	EX70001000		500	50	44	48,5	14	62,5
20x3/4"	16	EX70001001		500	50	44	48,5	15	63,5
25x1/2"	16	EX70001002		350	25	50	53	14	67
25x3/4"	16	EX70001003		350	25	50	53	15	68
25x1"	16	EX70001004		350	25	50	53	17	70
32x1/2"	16	EX70001005		250	25	61	57	14	71
32x3/4"	16	EX70001006		250	25	61	57	15	72
32x1"	16	EX70001007		225	25	61	57	17	74
32x1 1/4"	16	EX70001008		200	25	61	57	20	77
40x1"	16	EX70001009		150	15	74,5	73,5	17	90,5
40x1 1/4"	16	EX70001010		135	15	74,5	73,5	20	93,5
40x1 1/2"	16	EX70001011		135	15	74,5	73,5	20	93,5
50x1 1/4"	16	EX70001012		80	10	88	84,5	20	104,5
50x1 1/2"	16	EX70001013		80	10	88	84,5	20	104,5
50x2"	16	EX70001014		80	10	88	84,5	24	108,5
63x1 1/2"	16	EX70001015		48	6	101	92,5	20	112,5
63x2"	16	EX70001016		48	6	101	92,5	24	116,5
63x2 1/2"	16	EX70001017		48	6	101	92,5	28	120,5
75x2"	16	EX70001018		30		124	127	24	151
75x2 1/2"	16	EX70001019		30		124	127	28	155
75x3"	16	EX70001020		30		124	127	30	157
90x2"	16	EX70001021		16		149	159	24	183
90x2 1/2"	16	EX70001022		16		149	159	28	187
90x3"	16	EX70001023		16		149	159	30	189
90x4"	16	EX70001024		14		149	159	36	195
110x2"	16	EX70001025		12		185	117	24	117
110x2 1/2"	16	EX70001026		12		185	117	28	117
110x3"	16	EX70001027		12		185	117	30	147
110x4"	16	EX70001028		12		185	117	36	153

Kaplin Dişi Adaptör Metal Yüzlüklü
Female Adaptor Reinforcing Ring

YENİ / NEW

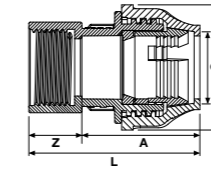

Çap Dia	Basınç Pn	Kod Code	Fiyat (Adet) Price (Pcs)	Koli Adet Box Pcs	Poşet İçi Adet Bag Pcs	D (mm)	A (mm)	Z (mm)	L (mm)
20x1/2"	16	EX70001000M		500	50	44	48,5	14	62,5
20x3/4"	16	EX70001001M		500	50	44	48,5	15	63,5
25x1/2"	16	EX70001002M		350	25	50	53	14	67
25x3/4"	16	EX70001003M		350	25	50	53	15	68
25x1"	16	EX70001004M		350	25	50	53	17	70
32x1/2"	16	EX70001005M		250	25	61	57	14	71
32x3/4"	16	EX70001006M		250	25	61	57	15	72
32x1"	16	EX70001007M		225	25	61	57	17	74
32x1 1/4"	16	EX70001008M		200	25	61	57	20	77
40x1"	16	EX70001009M		150	15	74,5	73,5	17	90,5
40x1 1/4"	16	EX70001010M		135	15	74,5	73,5	20	93,5
40x1 1/2"	16	EX70001011M		135	15	74,5	73,5	20	93,5
50x1 1/4"	16	EX70001012M		80	10	88	84,5	20	104,5
50x1 1/2"	16	EX70001013M		80	10	88	84,5	20	104,5
50x2"	16	EX70001014M		80	10	88	84,5	24	108,5
63x1 1/2"	16	EX70001015M		48	6	101	92,5	20	112,5
63x2"	16	EX70001016M		48	6	101	92,5	24	116,5
63x2 1/2"	16	EX70001017M		48	6	101	92,5	28	120,5
75x2"	16	EX70001018M		30		124	127	24	151
75x2 1/2"	16	EX70001019M		30		124	127	28	155
75x3"	16	EX70001020M		30		124	127	30	157
90x2"	16	EX70001021M		16		149	159	24	183
90x2 1/2"	16	EX70001022M		16		149	159	28	187
90x3"	16	EX70001023M		16		149	159	30	189
90x4"	16	EX70001024M		14		149	159	36	195
110x2"	16	EX70001025M		12		185	117	24	117
110x2 1/2"	16	EX70001026M		12		185	117	28	117
110x3"	16	EX70001027M		12		185	117	30	147
110x4"	16	EX70001028M		12		185	117	36	153

Kaplin Manşon
Coupling

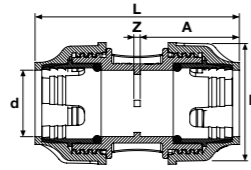

Çap Dia	Basınç Pn	Kod Code	Fiyat (Adet) Price (Pcs)	Koli Adet Box Pcs	Poşet İçi Adet Bag Pcs	D (mm)	A (mm)	Z (mm)	L (mm)
20x20	16	EX70001200		300	25	44	48,5	3	100
25x25	16	EX70001201		200	25	50	53	3	109
32x32	16	EX70001202		130	10	61	57	3	117
40x40	16	EX70001203		70	10	74,5	73,5	3	150
50x50	16	EX70001204		42	6	88	84,5	3	172
63x63	16	EX70001205		30	5	101	92,5	3	152
75x75	16	EX70001206		20		124	127	4	258
90x90	16	EX70001207		9		149	159	5	323
110x110	16	EX70001208		6		185	185	6	376

Kaplin Redüsiyon Manşon
Reducing Coupling

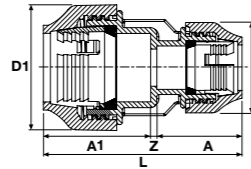

Çap Dia	Basınç Pn	Kod Code	Fiyat (Adet) Price (Pcs)	Koli Adet Box Pcs	Poşet İçi Adet Bag Pcs	D (mm)	A1 (mm)	Z (mm)	L (mm)	D1 (mm)	A (mm)
25x20	16	EX70001600		250	25	50	53	3	104,5	44	48,5
32x20	16	EX70001601		180	10	61	57	3	108,5	44	48,5
32x25	16	EX70001602		170	10	61	57	3	113	50	53
40x20	16	EX70001603		120	10	74,5	73,5	3	125	44	48,5
40x25	16	EX70001604		110	10	74,5	73,5	3	129,5	50	53
40x32	16	EX70001605		100	10	74,5	73,5	3	133,5	61	57
50x25	16	EX70001606		66	6	88	84,5	3	140,5	50	53
50x32	16	EX70001607		60	6	88	84,5	3	144,5	61	57
50x40	16	EX70001608		54	6	88	84,5	3	161	74,5	73,5
63x25	16	EX70001609		42	6	101	92,5	6	151,5	50	53
63x32	16	EX70001610		42	6	101	92,5	6	155,5	61	57
63x40	16	EX70001611		36	6	101	92,5	6	172	74,5	73,5
63x50	16	EX70001612		36	6	101	92,5	6	183	88	84,5
75x40	16	EX70001621		28		124	127	6	206,5	74,5	73,5
75x50	16	EX70001613		24		124	127	6	217,5	88	84,5
75x63	16	EX70001614		22		124	127	6	225,5	101	92,5
90x50	16	EX70001620		10		149	159	7	250,5	88	84,5
90x63	16	EX70001615		12		149	159	7	258,5	101	92,5
90x75	16	EX70001616		10		149	159	7	293	124	127
110x63	16	EX70001617		7		185	185	8	285,5	101	92,5
110x75	16	EX70001618		7		185	185	8	320	124	127
110x90	16	EX70001619		7		185	185	8	342	149	149

Kaplin Erkek Adaptör
Male Adaptor

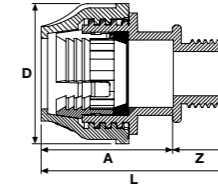

Çap Dia	Basınç Pn	Kod Code	Fiyat (Adet) Price (Pcs)	Koli Adet Box Pcs	Poşet İçi Adet Bag Pcs	D (mm)	A (mm)	Z (mm)	L (mm)
20x1/2"	16	EX70001100		600	50	44	48,5	14	62,5
20x3/4"	16	EX70001101		600	50	44	48,5	15	63,5
25x1/2"	16	EX70001102		425	25	50	53	14	67
25x3/4"	16	EX70001103		400	25	50	53	15	68
25x1"	16	EX70001104		400	25	50	53	17	70
32x1/2"	16	EX70001105		275	25	61	57	14	71
32x3/4"	16	EX70001106		275	25	61	57	15	72
32x1"	16	EX70001107		250	25	61	57	17	74
32x1 1/4"	16	EX70001108		250	25	61	57	20	77
40x1"	16	EX70001109		150	15	74,5	73,5	17	90,5
40x1 1/4"	16	EX70001110		135	15	74,5	73,5	20	93,5
40x1 1/2"	16	EX70001111		150	15	74,5	73,5	20	93,5
50x1 1/4"	16	EX70001112		80	10	88	84,5	20	104,5
50x1 1/2"	16	EX70001113		80	10	88	84,5	20	104,5
50x2"	16	EX70001114		80	10	88	84,5	24	108,5
63x1 1/2"	16	EX70001115		66	6	101	92,5	20	112,5
63x2"	16	EX70001116		55	6	101	92,5	24	116,5
63x2 1/2"	16	EX70001117		60	6	101	92,5	28	120,5
75x2"	16	EX70001118		32		124	127	24	151
75x2 1/2"	16	EX70001119		30		124	127	28	155
75x3"	16	EX70001120		28		124	127	30	157
90x2"	16	EX70001121		16		149	159	24	183
90x2 1/2"	16	EX70001122		16		149	159	28	187
90x3"	16	EX70001123		16		149	159	30	189
90x4"	16	EX70001124		16		149	159	36	195
110x2"	16	EX70001125		12		185	117	24	141
110x2 1/2"	16	EX70001126		12		185	117	28	145
110x3"	16	EX70001127		12		185	117	30	147
110x4"	16	EX70001128		12		185	117	36	153

Kaplin Kör Tapa
End Cap

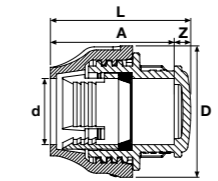

Çap Dia	Basınç Pn	Kod Code	Fiyat (Adet) Price (Pcs)	Koli Adet Box Pcs	Poşet İçi Adet Bag Pcs	D (mm)	A (mm)	Z (mm)	L (mm)
20	16	EX70001500		700	50	44	48,5	5,5	54
25	16	EX70001501		400	25	50	53	6,9	59,9
32	16	EX70001502		250	25	61	57	8,4	65,4
40	16	EX70001503		150	15	74,5	73,5	10	83,5
50	16	EX70001504		84	12	88	84,5	11,7	96,2
63	16	EX70001505		55	6	101	92,5	16	108,5
75	16	EX70001506		32		124	127	18	145
90	16	EX70001507		18		149	159	20	179
110	16	EX70001508		10		185	185	24	209

Kaplin Te
Tee

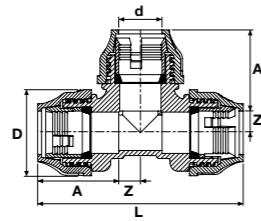

Çap Dia	Basınç Pn	Kod Code	Fiyat (Adet) Price (Pcs)	Koli Adet Box Pcs	Poşet İçi Adet Bag Pcs	D (mm)	A (mm)	Z (mm)	L (mm)
20	16	EX70001300		180	15	43,7	48,5	11	119
25	16	EX70001301		120	10	49,8	53	13,5	133
32	16	EX70001302		70	5	60,8	57	17	148
40	16	EX70001303		45	5	74,5	73,5	21	189
50	16	EX70001304		24	4	88	84,5	26	221
63	16	EX70001305		15	3	101	92,5	32,5	250
75	16	EX70001306		8		124	127	38,5	331
90	16	EX70001307		6		149	159	46	410
110	16	EX70001308		4		185	185	56	482

Kaplin Redüksiyon Te
Reducing Tee

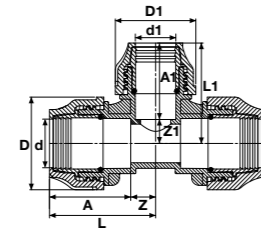

Çap Dia	Basınç Pn	Kod Code	Fiyat (Adet) Price (Pcs)	Koli Adet Box Pcs	Poşet İçi Adet Bag Pcs	D (mm)	A (mm)	Z (mm)	L (mm)	D1 (mm)	A1 (mm)	Z1 (mm)	L1 (mm)
25x20x25	16	EX70001700		140	10	50	53	13,5	133	44	48,5	11	119
32x20x32	16	EX70001701		85	5	61	57	17	148	44	48,5	11,0	119
32x25x32	16	EX70001702		80	5	61	57	17	148	50	53	13,5	133
40x25x40	16	EX70001703		50	5	74,5	73,5	21	189	50	53	13,5	133
40x32x40	16	EX70001704		50	5	74,5	73,5	21	189	61	57	17	148
50x25x50	16	EX70001705		32	4	88	84,5	26	221	50	53	13,5	133
50x32x50	16	EX70001706		40	4	88	84,5	26	221	61	57	17	148
50x40x50	16	EX70001707		28	4	88	84,5	26	221	74,5	73,5	21	189
63x25x63	16	EX70001708		21	3	101	92,5	32,5	250	50	53	13,5	133
63x32x63	16	EX70001709		24	3	101	92,5	32,5	250	61	57	17	148
63x40x63	16	EX70001710		18	3	101	92,5	32,5	250	74,5	73,5	21	189
63x50x63	16	EX70001711		18	3	101	92,5	32,5	250	88	84,5	26	221
75x50x75	16	EX70001712		12		124	127	38,5	331	88	84,5	26	221
75x63x75	16	EX70001713		12		124	127	38,5	331	101	92,5	32,5	250
90x63x90	16	EX70001714		7		149	159	46	410	101	92,5	32,5	250
90x75x90	16	EX70001715		6		149	159	46	410	124	127	38,5	331
110x63x110	16	EX70001716		4		185	185	56	482	101	92,5	32,5	250
110x75x110	16	EX70001717		4		185	185	56	482	124	127	38,5	331
110x90x110	16	EX70001718		4		185	185	56	482	149	159	46	410

Kaplin Erkek Te
Male Tee

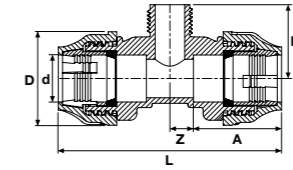

Çap Dia	Basınç Pn	Kod Code	Fiyat (Adet) Price (Pcs)	Koli Adet Box Pcs	Poşet İçi Adet Bag Pcs	D (mm)	A (mm)	Z (mm)	L (mm)	H (mm)
20x1/2"x20	16	EX70001900		300	15	44	48,5	11	119	34,5
20x3/4"x20	16	EX70001901		300	15	44	48,5	11	119	35,5
20x1"x20	16	EX70001929		225	15	44	48,5	11	119	39,5
25x1/2"x25	16	EX70001902		160	10	50	53	13,5	133	37,8
25x3/4"x25	16	EX70001903		180	10	50	53	13,5	133	38,8
25x1"x25	16	EX70001904		170	10	50	53	13,5	133	42,8
25x1 1/4"x25	16	EX70001905		170	10	50	53	13,5	133	44,8
32x1/2"x32	16	EX70001906		100	10	61	57	17	148	42,5
32x3/4"x32	16	EX70001907		100	10	61	57	17	148	43,5
32x1"x32	16	EX70001908		100	10	61	57	17	148	47,5
32x1 1/4"x32	16	EX70001909		100	10	61	57	17	148	49,5
40x1"x40	16	EX70001910		70	5	74,5	73,5	21	189	53,9
40x1 1/4"x40	16	EX70001911		70	5	74,5	73,5	21	189	55,9
40x1 1/2"x40	16	EX70001912		70	5	74,5	73,5	21	189	55,9
50x1"x50	16	EX70001913		44	4	88	84,5	26	221	59,9
50x1 1/4"x50	16	EX70001914		44	4	88	84,5	26	221	61,9
50x1 1/2"x50	16	EX70001915		40	4	88	84,5	26	221	61,9
50x2"x50	16	EX70001916		40	4	88	84,5	26	221	63,9
63x1 1/4"x63	16	EX70001917		24	3	101	92,5	32,5	250	69,3
63x1 1/2"x63	16	EX70001918		24	3	101	92,5	32,5	250	69,3
63x2"x63	16	EX70001919		21	3	101	92,5	32,5	250	71,3
63x2 1/2"x63	16	EX70001920		21	3	101	92,5	32,5	250	75,3
75x2"x75	16	EX70001921		18		124	127	38,5	331	82,5
75x2 1/2"x75	16	EX70001922		12		124	127	38,5	331	86,5
75x3"x75	16	EX70001923		18		124	127	38,5	331	88,5
90x2 1/2"x90	16	EX70001924		7		149	159	46	410	86,5
90x3"x90	16	EX70001925		7		149	159	46	410	88,5
90x4"x90	16	EX70001926		7		149	159	46	410	106,3
110x3"x110	16	EX70001927		4		185	185	56	430	100,3
110x4"x110	16	EX70001928		4		185	185	56	430	106,3

Kaplin Dişi Te
Female Tee

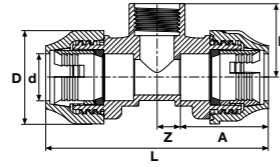

Çap Dia	Basınç Pn	Kod Code	Fiyat (Adet) Price (Pcs)	Koli Adet Box Pcs	Poşet İçi Adet Bag Pcs	D (mm)	A (mm)	Z (mm)	L (mm)	H (mm)
20x1/2"x20	16	EX70002300		315	15	44	48,5	11	119	34,5
20x3/4"x20	16	EX70002301		300	15	44	48,5	11	119	35,5
25x1/2"x25	16	EX70002302		170	10	50	53	13,5	133	37,8
25x3/4"x25	16	EX70002303		160	10	50	53	13,5	133	38,8
25x1"x25	16	EX70002304		160	10	50	53	13,5	133	42,8
32x1/2"x32	16	EX70002305		100	10	61	57	17	148	42,5
32x3/4"x32	16	EX70002306		120	10	61	57	17	148	43,5
32 x 1" x 32	16	EX70002307		90	10	61	57	17	148	47,5
40x3/4"x40	16	EX70002308		65	5	74,5	73,5	21	189	49,9
40x1"x40	16	EX70002309		65	5	74,5	73,5	21	189	53,9
40x1 1/4"x40	16	EX70002310		65	5	74,5	73,5	21	189	55,9
50x1"x50	16	EX70002311		40	4	88	84,5	26	221	59,9
50x1 1/4"x50	16	EX70002312		40	4	88	84,5	26	221	61,9
50x1 1/2"x50	16	EX70002313		40	4	88	84,5	26	221	61,9
63x1 1/4"x63	16	EX70002314		24	3	101	92,5	32,5	250	69,3
63x1 1/2"x63	16	EX70002315		21	3	101	92,5	32,5	250	69,3
63x2"x63	16	EX70002316		20	3	101	92,5	32,5	250	71,3
75x2"x75	16	EX70002317		12		124	127	38,5	331	82,5
75x2 1/2"x75	16	EX70002318		12		124	127	38,5	331	86,5
90x2 1/2"x90	16	EX70002319		8		149	159	46	410	98,3
90x3"x90	16	EX70002320		8		149	159	46	410	100,3
110x3"x110	16	EX70002321		4		185	185	56	482	112,5
110x4"x110	16	EX70002322		4		185	185	56	482	118,5

Kaplin Dişi Te Metal Yüzlü
Female Tee Reinforcing Ring

YENİ / NEW

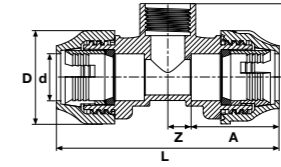

Çap Dia	Basınç Pn	Kod Code	Fiyat (Adet) Price (Pcs)	Koli Adet Box Pcs	Poşet İçi Adet Bag Pcs	D (mm)	A (mm)	Z (mm)	L (mm)	H (mm)
20x1/2"x20	16	EX70002300M		315	15	44	48,5	11	119	34,5
20x3/4"x20	16	EX70002301M		300	15	44	48,5	11	119	35,5
25x1/2"x25	16	EX70002302M		170	10	50	53	13,5	133	37,8
25x3/4"x25	16	EX70002303M		160	10	50	53	13,5	133	38,8
25x1"x25	16	EX70002304M		160	10	50	53	13,5	133	42,8
32x1/2"x32	16	EX70002305M		100	10	61	57	17	148	42,5
32x3/4"x32	16	EX70002306M		120	10	61	57	17	148	43,5
32 x 1" x 32	16	EX70002307M		90	10	61	57	17	148	47,5
40x3/4"x40	16	EX70002308M		65	5	74,5	73,5	21	189	49,9
40x1"x40	16	EX70002309M		65	5	74,5	73,5	21	189	53,9
40x1 1/4"x40	16	EX70002310M		65	5	74,5	73,5	21	189	55,9
50x1"x50	16	EX70002311M		40	4	88	84,5	26	221	59,9
50x1 1/4"x50	16	EX70002312M		40	4	88	84,5	26	221	61,9
50x1 1/2"x50	16	EX70002313M		40	4	88	84,5	26	221	61,9
63x1 1/4"x63	16	EX70002314M		24	3	101	92,5	32,5	250	69,3
63x1 1/2"x63	16	EX70002315M		21	3	101	92,5	32,5	250	69,3
63x2"x63	16	EX70002316M		20	3	101	92,5	32,5	250	71,3
75x2"x75	16	EX70002317M		12		124	127	38,5	331	82,5
75x2 1/2"x75	16	EX70002318M		12		124	127	38,5	331	86,5
90x2 1/2"x90	16	EX70002319M		8		149	159	46	410	98,3
90x3"x90	16	EX70002320M		8		149	159	46	410	100,3
110x3"x110	16	EX70002321M		4		185	185	56	482	112,5
110x4"x110	16	EX70002322M		4		185	185	56	482	118,5

Kaplin Dirsek
Elbow

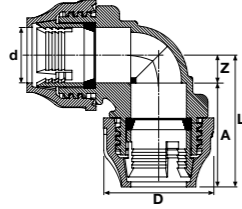

Çap Dia	Basınç Pn	Kod Code	Fiyat (Adet) Price (Pcs)	Koli Adet Box Pcs	Poşet İçi Adet Bag Pcs	D (mm)	A (mm)	Z (mm)	L (mm)
20x20	16	EX70001400		300	25	44	48,5	11	59,5
25x25	16	EX70001401		195	15	50	53	13,5	66,5
32x32	16	EX70001402		120	10	61	57	17	74
40x40	16	EX70001403		60	5	74,5	73,5	21	94,5
50x50	16	EX70001404		40	4	88	84,5	26	110,5
63x63	16	EX70001405		25	4	101	92,5	32,5	125
75x75	16	EX70001406		12		124	127	38,5	165,5
90x90	16	EX70001407		8		149	159	46	205
110x110	16	EX70001408		6		185	185	56	241

Kaplin Redüksiyon Dirsek
Reducing Elbow

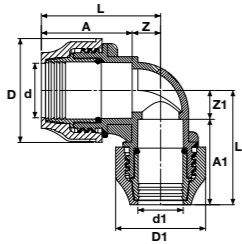

Çap Dia	Basınç Pn	Kod Code	Fiyat (Adet) Price (Pcs)	Koli Adet Box Pcs	Poşet İçi Adet Bag Pcs	D (mm)	A (mm)	Z (mm)	L (mm)	D1 (mm)	A1 (mm)	Z1 (mm)	L1 (mm)
25x20	16	EX70001800		210	15	50	53	13,5	66,5	44	48,5	11	59,5
32x25	16	EX70001801		150	10	61	57	17	74	50	53	13,5	66,5
40x32	16	EX70001802		85	5	74,5	73,5	21	94,5	61	57	17	74
50x40	16	EX70001803		52	4	88	84,5	26	110,5	74,5	73,5	21	94,5
63x50	16	EX70001804		32	4	101	92,5	32,5	125	88	84,5	26	110,5
75x63	16	EX70001805		18		124	127	38,5	165,5	101	92,5	32,5	125
90x75	16	EX70001806		8		149	159	46	205	124	127	38,5	165,5
110x90	16	EX70001808		5		185	185	56	241	149	159	46	205

Kaplin Erkek Dirsek
Male Elbow

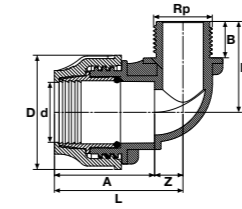

Çap Dia	Basınç Pn	Kod Code	Fiyat (Adet) Price (Pcs)	Koli Adet Box Pcs	Poşet İçi Adet Bag Pcs	D (mm)	A (mm)	Z (mm)	L (mm)	B (mm)	L1 (mm)
20x1/2"	16	EX70002000		475	25	44	42,5	11	53,5	14	25
20x3/4"	16	EX70002001		475	25	44	42,5	11	53,5	15	26
20x1"	16	EX70002025		400	25	44	42,5	11	53,5	17	28
25x1/2"	16	EX70002002		345	15	50	47,5	13,5	61	14	27,5
25x3/4"	16	EX70002003		330	15	50	47,5	13,5	61	15	28,5
25x1"	16	EX70002004		315	15	50	47,5	13,5	61	17	30,5
32x3/4"	16	EX70002005		210	10	61	50,5	17	67,5	15	32
32x1"	16	EX70002006		200	10	61	50,5	17	67,5	17	34
32x1 1/4"	16	EX70002007		200	10	61	50,5	17	67,5	20	37
40x1"	16	EX70002008		110	5	74,5	63	21	84	17	38
40x1 1/4"	16	EX70002009		110	5	74,5	63	21	84	20	41
40x1 1/2"	16	EX70002010		135	5	74,5	63	21	84	20	41
50x1 1/4"	16	EX70002011		68	4	88	70,5	26	96,5	20	46
50x1 1/2"	16	EX70002012		60	4	88	70,5	26	96,5	20	46
50x2"	16	EX70002013		64	4	88	70,5	26	96,5	24	50
63x1 1/2"	16	EX70002014		40	4	101	80,5	32,5	113	20	52,5
63x2"	16	EX70002015		40	4	101	80,5	32,5	113	24	56,5
63x2 1/2"	16	EX70002016		36	4	101	80,5	32,5	144,5	28	60,5
75x2"	16	EX70002017		24		124	112	38,5	150,5	24	62,5
75x2 1/2"	16	EX70002018		24		124	112	38,5	150,5	28	66,5
75x3"	16	EX70002019		22		124	112	38,5	180,5	30	68,5
90x2 1/2"	16	EX70002020		14		149	142	46	188	28	74
90x3"	16	EX70002021		14		149	142	46	188	30	76
90x4"	16	EX70002022		10		149	142	46	219	36	82
110x2 1/2"	16	EX70002026		9		185	173	56	229	28	84
110x3"	16	EX70002023		8		185	173	56	229	30	86
110x4"	16	EX70002024		8		185	173	56	229	36	92

Kaplin Dişi Dirsek
Female Elbow

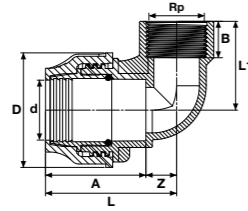

Çap Dia	Basınç Pn	Kod Code	Fiyat (Adet) Price (Pcs)	Koli Adet Box Pcs	Poşet İçi Adet Bag Pcs	D (mm)	A (mm)	Z (mm)	L (mm)	B (mm)	L1 (mm)
20x1/2"	16	EX70002400		450	25	44	48,5	11	59,5	14	25
20x3/4"	16	EX70002401		450	25	44	48,5	11	59,5	15	26
25x1/2"	16	EX70002402		330	15	50	53	13,5	66,5	14	27,5
25x3/4"	16	EX70002403		300	15	50	53	13,5	66,5	15	28,5
25x1"	16	EX70002404		270	15	50	53	13,5	66,5	17	30,5
32x3/4"	16	EX70002405		130	10	61	57	17	74	15	32
32x1"	16	EX70002406		120	10	61	57	17	74	17	34
32x1 1/4"	16	EX70002407		120	10	61	57	17	74	20	37
40x1"	16	EX70002408		110	5	74,5	73,5	21	94,5	17	38
40x1 1/4"	16	EX70002409		100	5	74,5	73,5	21	94,5	20	41
40x1 1/2"	16	EX70002410		95	5	74,5	73,5	21	94,5	20	41
50x1 1/4"	16	EX70002411		60	4	88	84,5	26	110,5	20	46
50x1 1/2"	16	EX70002412		60	4	88	84,5	26	110,5	20	46
63x1 1/2"	16	EX70002413		40	4	101	92,5	32,5	125	20	52,5
63x2"	16	EX70002414		36	4	101	92,5	32,5	125	24	56,5
75x2"	16	EX70002415		22		124	127	38,5	165,5	24	62,5
75x2 1/2"	16	EX70002416		22		124	127	38,5	165,5	28	66,5
90x2 1/2"	16	EX70002417		14		149	159	46	205	28	74
90x3"	16	EX70002418		12		149	159	46	205	30	76
110x3"	16	EX70002419		8		185	185	56	241	30	86
110x4"	16	EX70002420		8		185	185	56	241	36	92

Kaplin Dişi Dirsek Metal Yüzüklü
Female Elbow Reinforcing Ring

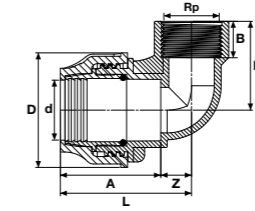

Çap Dia	Basınç Pn	Kod Code	Fiyat (Adet) Price (Pcs)	Koli Adet Box Pcs	Poşet İçi Adet Bag Pcs	D (mm)	A (mm)	Z (mm)	L (mm)	B (mm)	L1 (mm)
20x1/2"	16	EX70002400M		450	25	44	48,5	11	59,5	14	25
20x3/4"	16	EX70002401M		450	25	44	48,5	11	59,5	15	26
25x1/2"	16	EX70002402M		330	15	50	53	13,5	66,5	14	27,5
25x3/4"	16	EX70002403M		300	15	50	53	13,5	66,5	15	28,5
25x1"	16	EX70002404M		270	15	50	53	13,5	66,5	17	30,5
32x3/4"	16	EX70002405M		130	10	61	57	17	74	15	32
32x1"	16	EX70002406M		120	10	61	57	17	74	17	34
32x1 1/4"	16	EX70002407M		120	10	61	57	17	74	20	37
40x1"	16	EX70002408M		110	5	74,5	73,5	21	94,5	17	38
40x1 1/4"	16	EX70002409M		100	5	74,5	73,5	21	94,5	20	41
40x1 1/2"	16	EX70002410M		95	5	74,5	73,5	21	94,5	20	41
50x1 1/4"	16	EX70002411M		60	4	88	84,5	26	110,5	20	46
50x1 1/2"	16	EX70002412M		60	4	88	84,5	26	110,5	20	46
63x1 1/2"	16	EX70002413M		40	4	101	92,5	32,5	125	20	52,5
63x2"	16	EX70002414M		36	4	101	92,5	32,5	125	24	56,5
75x2"	16	EX70002415M		22		124	127	38,5	165,5	24	62,5
75x2 1/2"	16	EX70002416M		22		124	127	38,5	165,5	28	66,5
90x2 1/2"	16	EX70002417M		14		149	159	46	205	28	74
90x3"	16	EX70002418M		12		149	159	46	205	30	76
110x3"	16	EX70002419M		8		185	185	56	241	30	86
110x4"	16	EX70002420M		8		185	185	56	241	36	92

YENİ / NEW

Adaptör Sıkma Anahtarı
Adapter Key

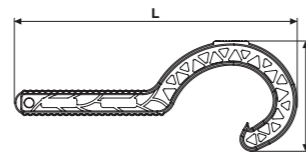

Çap Dia	Kod Code	Fiyat (Adet) Price (Pcs)	Çuval Adet Sack Pcs	Poşet İçi Adet Bag Pcs	L (mm)	h (mm)
20x25x32	EX70003000		700		236	92
40x50x63x75	EX70003001		230		338	112,5
90x110	EX70003002		50		456	151,5

Plastik Dişli Redüksiyon
Plastic Threaded Reducer



Çap Dia	Basınç Pn	Kod Code	Fiyat (Adet) Price (Pcs)	Çuval Adet Sack Pcs	Poşet İçi Adet Bag Pcs
3/4"x1/2"	16	EX70005000		3000	
1"x 3/4"	16	EX70005001		1800	
1 1/4"x1"	16	EX70005002		1000	
1 1/2"x1 1/4"	16	EX70005003		700	
2"x1 1/2"	16	EX70005004		400	

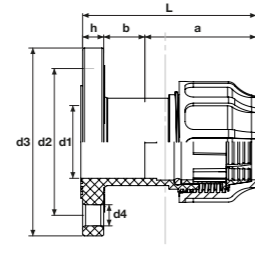

TİP-A / TYPE A

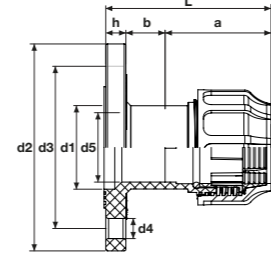

TİP-B / TYPE B

TİP-A / TYPE A

Çap Dia	Basınç Pn	Kod Code	Fiyat (Adet) Price (Pcs)	Koli Adet Box Pcs	Poşet İçi Adet Bag Pcs	DN (mm)	DN (Inch)	d1 (mm)	L (mm)	B (mm)	A (mm)	d2 (mm)	d3 (mm)	h (mm)	d4 (mm)
63	16	EX70002503				50	2"	62	127,7	35	74,7	160	125	18	18
75	16	EX70002504				65	2 1/2"	74,7	156	41	95	185	145	20	18
90	16	EX70002505				80	3"	90,7	190	44	124	200	160	22	18

TİP-B / TYPE B

Çap Dia	Basınç Pn	Kod Code	Fiyat (Adet) Price (Pcs)	Koli Adet Box Pcs	Poşet İçi Adet Bag Pcs	DN (mm)	DN (Inch)	d1 (mm)	d5 (mm)	L (mm)	B (mm)	A (mm)	d2 (mm)	d3 (mm)	h (mm)	d4 (mm)
63	16	EX70002603				65	2 1/2"	62	74,7	127,7	35	74,7	185	145	18	18
75	16	EX70002604				80	3"	74,7	90,7	156	41	95	200	160	20	18
90	16	EX70002605				100	4"	90,7	116,1	190	44	124	220	181	22	18
110	16	EX70002606				100	4"	110	116,1	227,5	53	150,5	220	181	24	18

PP-B

KAPLIN EK PARÇALAR COMPRESSION FITTINGS

ÜRETİM STANDARDI

PRODUCTION STANDARD

TS ISO 17885

ÇAP / SIZE Ø20 - Ø110

YENİ / NEW

YEŞİL SERİ
GREEN SERIES

PN 10



Kaplin Erkek Adaptör
Male Adaptor

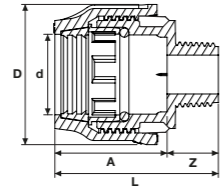

Çap Dia	Basınç Pn	Kod Code	Fiyat (Adet) Price (Pcs)	Koli Adet Box Pcs	Poşet İçi Adet Bag Pcs	D (mm)	A (mm)	Z (mm)	L (mm)
20x1/2"	10	GR70001100		800	50	37,5	34,2	16,5	50,7
20x3/4"	10	GR70001101		750	50	37,5	34,2	17,5	51,7
25x1/2"	10	GR70001102		550	25	46	36,5	16,8	53,3
25x3/4"	10	GR70001103		500	25	46	36,5	17,8	54,3
25x1"	10	GR70001104		450	25	46	36,5	19,8	56,3
32x1/2"	10	GR70001105		350	25	56,5	43,6	17,2	60,8
32x3/4"	10	GR70001106		325	25	56,5	43,6	18,2	61,8
32x1"	10	GR70001107		300	25	56,5	43,6	20,2	63,8
32x1 1/4"	10	GR70001108		300	25	56,5	43,6	23,2	66,8
40x1"	10	GR70001109		180	15	68	49,2	20,6	69,8
40x1 1/4"	10	GR70001110		165	15	68	49,2	23,6	72,8
40x1 1/2"	10	GR70001111		165	15	68	49,2	23,6	72,8
50x1 1/4"	10	GR70001112		110	10	84,4	59,2	24,2	83,4
50x1 1/2"	10	GR70001113		100	10	84,4	59,2	24,2	83,4
50x2"	10	GR70001114		90	10	84,4	59,2	28,2	87,4
63x1 1/2"	10	GR70001115		72	6	101,8	69,4	24,7	94,1
63x2"	10	GR70001116		66	6	101,8	69,4	28,7	98,1
63x2 1/2"	10	GR70001117		60	6	101,8	69,4	32,7	102,1
75x2"	10	GR70001118		36	4	118,8	111,6	31,5	143,1
75x2 1/2"	10	GR70001119		32	4	118,8	111,6	33,5	145,1
75x3"	10	GR70001120		32	4	118,8	111,6	38,5	150,1
90x2 1/2"	10	GR70001121		24	4	139,6	124,9	34,55	159,45
90x3"	10	GR70001122		24	4	139,6	124,9	39,55	164,45
90x4"	10	GR70001123		20	4	139,6	124,9	43,55	168,45
110x3"	10	GR70001124		14	2	164,2	144,5	39,95	184,45
110x4"	10	GR70001125		12	2	164,2	144,5	43,95	188,45

Kaplin Dişi Adaptör
Female Adaptor

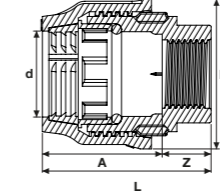

Çap Dia	Basınç Pn	Kod Code	Fiyat (Adet) Price (Pcs)	Koli Adet Box Pcs	Poşet İçi Adet Bag Pcs	D (mm)	A (mm)	Z (mm)	L (mm)
20x1/2"	10	GR70001000		650	50	37,5	34,2	17	51,2
20x3/4"	10	GR70001001		600	50	37,5	34,2	20	54,2
25x1/2"	10	GR70001002		450	25	46	36,5	15	51,5
25x3/4"	10	GR70001003		425	25	46	36,5	18	54,5
25x1"	10	GR70001004		350	25	46	36,5	24	60,5
32x1/2"	10	GR70001005				56,5	43,6	15	58,6
32x3/4"	10	GR70001006		300	25	56,5	43,6	16	59,6
32x1"	10	GR70001007		250	25	56,5	43,6	22	65,6
32x1 1/4"	10	GR70001008		200	25	56,5	43,6	25	68,6
40x1"	10	GR70001009		150	15	68	49,2	20	69,2
40x1 1/4"	10	GR70001010		150	15	68	49,2	25	74,2
40x1 1/2"	10	GR70001011		135	15	68	49,2	25	74,2
50x1 1/4"	10	GR70001012		100	10	84,4	59,2	22	81,2
50x1 1/2"	10	GR70001013		100	10	84,4	59,2	24	83,2
50x2"	10	GR70001014		80	10	84,4	59,2	27	86,2
63x1 1/2"	10	GR70001015		66	6	101,8	69,4	22	91,4
63x2"	10	GR70001016		60	6	101,8	69,4	26	95,4
63x2 1/2"	10	GR70001017		54	6	101,8	69,4	31	100,4
75x2"	10	GR70001018		36	4	118,8	111,6	31	142,6
75x2 1/2"	10	GR70001019		32	4	118,8	111,6	33	144,6
75x3"	10	GR70001020		28	4	118,8	111,6	38	149,6
90x2 1/2"	10	GR70001021		20	4	139,6	124,9	34	158,9
90x3"	10	GR70001022		20	4	139,6	124,9	39	163,9
90x4"	10	GR70001023		20	4	139,6	124,9	43	167,9
110x3"	10	GR70001024		14	2	164,2	144,5	39	183,5
110x4"	10	GR70001025		12	2	164,2	144,5	43	187,5

Kaplin Manşon
Coupling

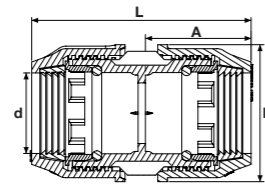

Çap Dia	Basınç Pn	Kod Code	Fiyat (Adet) Price (Pcs)	Koli Adet Box Pcs	Poşet İçi Adet Bag Pcs	D (mm)	A (mm)	L (mm)
20x20	10	GR70001200		400	25	37,5	34,2	71,8
25x25	10	GR70001201		275	25	46	36,5	76,3
32x32	10	GR70001202		180	10	56,5	43,6	90,5
40x40	10	GR70001203		100	10	68	49,2	101,7
50x50	10	GR70001204		66	6	84,4	59,2	122,7
63x63	10	GR70001205		40	5	101,8	69,4	143,1
75x75	10	GR70001206		18	2	118,8	111,6	227,3
90x90	10	GR70001207		14	2	139,6	124,9	253,8
110x110	10	GR70001208		8	1	164,2	144,5	294

Kaplin Kör Tapa
End Cap

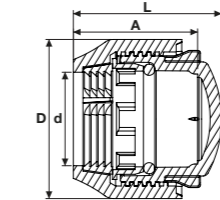

Çap Dia	Basınç Pn	Kod Code	Fiyat (Adet) Price (Pcs)	Koli Adet Box Pcs	Poşet İçi Adet Bag/Pcs	D (mm)	A (mm)	L (mm)
20x20	10	GR70001500		800	50	37,5	34,2	39,7
25x25	10	GR70001501		550	25	46	36,5	43,4
32x32	10	GR70001502		350	25	56,5	43,6	52
40x40	10	GR70001503		195	15	68	49,2	59,2
50x50	10	GR70001504		120	12	84,4	59,2	70,9
63x63	10	GR70001505		84	6	101,8	69,4	85,4
75x75	10	GR70001506		40	4	118,8	111,6	129,6
90x90	10	GR70001507		24	4	139,6	124,9	144,9
110x110	10	GR70001508		14	2	164,2	144,5	168,5

Kaplin Redüksiyon Manşon
Reducing Coupling

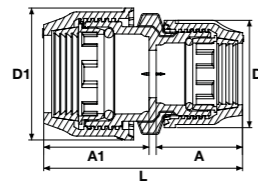

Çap Dia	Basınç Pn	Kod Code	Fiyat (Adet) Price (Pcs)	Koli Adet Box Pcs	Poşet İçi Adet Bag Pcs	A1 (mm)	D1 (mm)	A (mm)	D (mm)	L (mm)
25x20	10	GR70001600		350	25	36,5	46	34,2	37,5	73,7
32x20	10	GR70001601		270	10	43,6	56,5	34,2	37,5	80,8
32x25	10	GR70001602		220	10	43,6	56,5	36,5	46	83,1
40x20	10	GR70001603		140	10	49,2	68	34,2	37,5	86,4
40x25	10	GR70001604		140	10	49,2	68	36,5	46	88,7
40x32	10	GR70001605		120	10	49,2	68	43,6	56,5	95,8
50x25	10	GR70001606		96	6	59,2	84,4	36,5	46	98,7
50x32	10	GR70001607		90	6	59,2	84,4	43,6	56,5	105,8
50x40	10	GR70001608		78	6	59,2	84,4	49,2	68	111,4
63x25	10	GR70001609				69,4	101,8	36,5	46	111,9
63x32	10	GR70001610		72	6	69,4	101,8	43,6	56,5	119
63x40	10	GR70001611		60	6	69,4	101,8	49,2	68	124,6
63x50	10	GR70001612		48	6	69,4	101,8	59,2	84,4	134,6
75x50	10	GR70001613		32	2	111,6	118,8	59,2	84,4	176,8
75x63	10	GR70001614		28	2	111,6	118,8	69,4	101,8	187
90x63	10	GR70001615		20	2	124,9	139,6	69,4	101,8	200,3
90x75	10	GR70001616		16	2	124,9	139,6	111,6	118,8	242,5
110x75	10	GR70001618		12	1	144,5	164,2	111,6	118,8	262,1
110x90	10	GR70001619		10	1	144,5	164,2	124,9	139,6	275,4

Adaptör Sıkma Anahtarı
Adapter Key

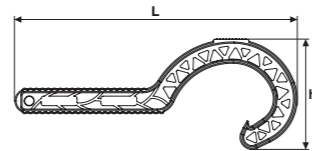

Çap Dia	Kod Code	Fiyat (Adet) Price (Pcs)	Çuval Adet Sack Pcs	Poşet İçi Adet Bag Pcs	L (mm)	h (mm)
20x25x32	EX70003000		700		236	92
40x50x63x75	EX70003001		230		338	112,5
90x110	EX70003002		50		456	151,5

Kaplin Te
Tee

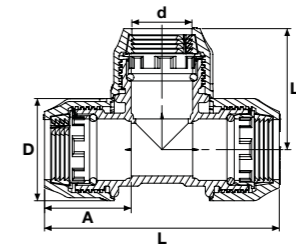

Çap Dia	Basınç Pn	Kod Code	Fiyat (Adet) Price (Pcs)	Koli Adet Box Pcs	Poşet İçi Adet Bag/Pcs	D (mm)	A (mm)	L (mm)	L1 (mm)
20x20x20	10	GR70001300		240	15	37,5	34,2	90,4	45,2
25x25x25	10	GR70001301		150	10	46	36,5	100	50
32x32x32	10	GR70001302		100	5	56,5	43,6	122,2	61,1
40x40x40	10	GR70001303		50	5	68	49,2	141,4	70,7
50x50x50	10	GR70001304		36	4	84,4	59,2	171,4	85,7
63x63x63	10	GR70001305		24	3	101,8	69,4	204,8	102,4
75x75x75	10	GR70001306		11	1	118,8	111,6	310,2	155,1
90x90x90	10	GR70001307		8	1	139,6	124,9	355,8	177,9
110x110x110	10	GR70001308		4	1	164,2	144,5	409	204,5

Kaplin Redüksiyon Te
Reducing Tee

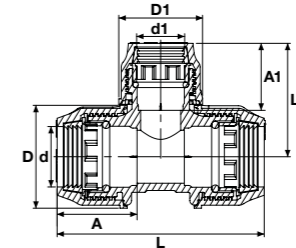

Çap Dia	Basınç Pn	Kod Code	Fiyat (Adet) Price (Pcs)	Koli Adet Box Pcs	Poşet İçi Adet Bag Pcs	A (mm)	D (mm)	A1 (mm)	D1 (mm)	L (mm)	L1 (mm)
25x20x25	10	GR70001700		190	10	36,5	46	34,2	37,5	96,6	52,45
32x20x32	10	GR70001701		120	5	43,6	56,5	34,2	37,5	110,8	59,7
32x25x32	10	GR70001702		110	5	43,6	56,5	36,5	46	113,2	62
40x25x40	10	GR70001703		65	5	49,2	68	36,5	46	124,4	65,6
40x32x40	10	GR70001704		60	5	49,2	68	43,6	56,5	131,4	72,7
50x25x50	10	GR70001705		48	4	59,2	84,4	36,5	46	144,4	75,2
50x32x50	10	GR70001706		48	4	59,2	84,4	43,6	56,5	151,4	82,3
50x40x50	10	GR70001707		40	4	59,2	84,4	49,2	68	159,4	85,9
63x25x63	10	GR70001708				69,4	101,8	36,5	46	164,8	81,6
63x32x63	10	GR70001709		30	3	69,4	101,8	43,6	56,5	171,8	88,7
63x40x63	10	GR70001710		27	3	69,4	101,8	49,2	68	179,8	93,3
63x50x63	10	GR70001711		24	3	69,4	101,8	59,2	84,4	188,5	102,3

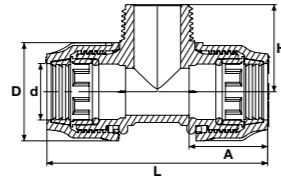
Kaplin Erkek Te
 Male Tee

Çap Dia	Basınç Pn	Kod Code	Fiyat (Adet) Price (Pcs)	Koli Adet Box Pcs	Poşet İçi Adet Bag/Pcs	D (mm)	A (mm)	L (mm)	H (mm)
20x1/2"x20	10	GR70001900		300	15	37,5	34,2	84,4	34,5
20x3/4"x20	10	GR70001901		300	15	37,5	34,2	89,4	35,5
20x1"x20	10	GR70001929				37,5	34,2	98,2	37,5
25x1/2"x25	10	GR70001902		210	10	46	36,5	91,34	37,8
25x3/4"x25	10	GR70001903		200	10	46	36,5	96,64	38,8
25x1"x25	10	GR70001904		200	10	46	36,5	102,8	40,8
25x1 1/4"x25	10	GR70001905		140	10	46	36,5	111,28	43,8
32x1/2"x32	10	GR70001906		140	10	56,5	43,6	105,54	43,5
32x3/4"x32	10	GR70001907		140	10	56,5	43,6	107,2	43,5
32x1"x32	10	GR70001908		130	10	56,5	43,6	116,2	47,5
32x1 1/4"x32	10	GR70001909		120	10	56,5	43,6	125,48	49,5
40x1"x40	10	GR70001910		70	5	68	49,2	118,4	54
40x1 1/4"x40	10	GR70001911		70	5	68	49,2	136,7	56
40x1 1/2"x40	10	GR70001912		60	5	68	49,2	139,4	58
50x1"x50	10	GR70001913		48	4	84,4	59,2	140,4	60
50x1 1/4"x50	10	GR70001914		48	4	84,4	59,2	152,4	62
50x1 1/2"x50	10	GR70001915		44	4	84,4	59,2	154,4	64
50x2"x50	10	GR70001916		36	4	84,4	59,2	166,4	66
63x1 1/4"x63	10	GR70001917		30	3	101,8	69,4	167,8	69
63x1 1/2"x63	10	GR70001918		30	3	101,8	69,4	168,8	71
63x2"x63	10	GR70001919		27	3	101,8	69,4	181,8	74,5
63x2 1/2"x63	10	GR70001920		24	3	101,8	69,4	190,8	78,9
75x2"x75	10	GR70001921		18	1	118,8	111,6	283,2	83
75x2 1/2"x75	10	GR70001922		16	1	118,8	111,6	298,2	87
75x3"x75	10	GR70001923		13	1	118,8	111,6	306,2	89
90x2 1/2"x90	10	GR70001924		10	1	139,6	124,9	324,8	93
90x3"x90	10	GR70001925		9	1	139,6	124,9	337,8	95
90x4"x90	10	GR70001926		9	1	139,6	124,9	363,8	106,3
110x3"x110	10	GR70001927		6	1	164,2	144,5	375	105
110x4"x110	10	GR70001928		7	1	164,2	144,5	399	110,3

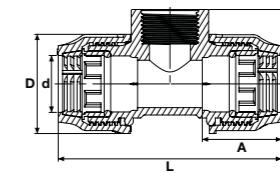
Kaplin Dişi Te
 Female Tee

Çap Dia	Basınç Pn	Kod Code	Fiyat (Adet) Price (Pcs)	Koli Adet Box Pcs	Poşet İçi Adet Bag Pcs	D (mm)	A (mm)	L (mm)	H (mm)
20x1/2"x20	10	GR70002300		270	15	37,5	34,2	92,4	29,2
20x3/4"x20	10	GR70002301		270	15	37,5	34,2	98,4	31,7
25x1/2"x25	10	GR70002302		200	10	46	36,5	97	32
25x3/4"x25	10	GR70002303		180	10	46	36,5	103	34,5
25x1"x25	10	GR70002304		180	10	46	36,5	111	40
32x1/2"x32	10	GR70002305		140	10	56,5	43,6	111,2	35,6
32x3/4"x32	10	GR70002306		130	10	56,5	43,6	117,2	38,1
32x1"x32	10	GR70002307		120	10	56,5	43,6	125,2	43,6
40x3/4"x40	10	GR70002308		70	5	68	49,2	128,4	41,3
40x1"x40	10	GR70002309		70	5	68	49,2	132,4	46,8
40x1 1/4"x40	10	GR70002310		60	5	68	49,2	140,4	48,8
50x1"x50	10	GR70002311		48	4	84,4	59,2	150,4	50,9
50x1 1/4"x50	10	GR70002312		44	4	84,4	59,2	160,4	52,9
50x1 1/2"x50	10	GR70002313		44	4	84,4	59,2	166,8	53,9
63x1 1/4"x63	10	GR70002314		27	3	101,8	69,4	172,8	58,3
63x1 1/2"x63	10	GR70002315		27	3	101,8	69,4	175,8	59,3
63x2"x63	10	GR70002316		27	3	101,8	69,4	190,8	62
75x2"x75	10	GR70002317		18	1	118,8	111,6	287,2	88
75x2 1/2"x75	10	GR70002318		15	1	118,8	111,6	302,2	92
75x3"x75	10	GR70002319		12	1	118,8	111,6	304,2	97
90x2 1/2"x90	10	GR70002320		10	1	139,6	124,9	330,8	101
90x3"x90	10	GR70002321		10	1	139,6	124,9	345,8	103,5
90x4"x90	10	GR70002322		9	1	139,6	124,9	359,8	112
110x3"x110	10	GR70002323		6	1	164,2	144,5	387	117,5
110x4"x110	10	GR70002324		5	1	164,2	144,5	402	126

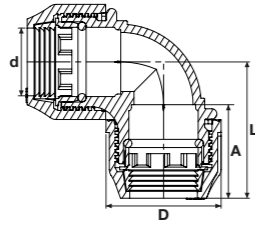
Kaplin Dirsek
 Elbow

Çap Dia	Basınç Pn	Kod Code	Fiyat (Adet) Price (Pcs)	Koli Adet Box Pcs	Poşet İçi Adet Bag Pcs	D (mm)	A (mm)	L (mm)
20x20	10	GR70001400		400	25	37,5	34,2	48,2
25x25	10	GR70001401		255	15	46	36,5	55,5
32x32	10	GR70001402		160	10	56,5	43,6	64,6
40x40	10	GR70001403		85	5	68	49,2	74,7
50x50	10	GR70001404		48	4	84,4	59,2	90,2
63x63	10	GR70001405		32	4	101,8	69,4	103,6
75x75	10	GR70001406		16	2	118,8	111,6	154,7
90x90	10	GR70001407		12	1	139,6	124,9	180
110x110	10	GR70001408		6	1	164,2	144,5	206,5

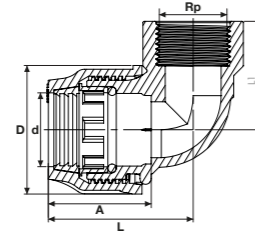
Kaplin Dişi Dirsek
 Female Elbow

Çap Dia	Basınç Pn	Kod Code	Fiyat (Adet) Price (Pcs)	Koli Adet Box Pcs	Poşet İçi Adet Bag Pcs	D (mm)	A (mm)	L (mm)	L1 (mm)
20x1/2"	10	GR70002400		500	25	37,5	34,2	46,2	29,2
20x3/4"	10	GR70002401		500	25	37,5	34,2	49,2	31,7
25x1/2"	10	GR70002402		375	15	46	36,5	48,5	32
25x3/4"	10	GR70002403		345	15	46	36,5	51,5	34,5
25x1"	10	GR70002404		300	15	46	36,5	55,5	40
32x3/4"	10	GR70002405		240	10	56,5	43,6	58,6	38,1
32x1"	10	GR70002406		200	10	56,5	43,6	62,6	43,6
32x1 1/4"	10	GR70002407		170	10	56,5	43,6	67,6	45
40x1"	10	GR70002408		120	5	68	49,2	66,2	46,8
40x1 1/4"	10	GR70002409		100	5	68	49,2	70,2	48,8
40x1 1/2"	10	GR70002410		100	5	68	49,2	73,2	49,4
50x1 1/4"	10	GR70002411		76	4	84,4	59,2	80,2	52,9
50x1 1/2"	10	GR70002412		72	4	84,4	59,2	83,4	53,9
63x1 1/2"	10	GR70002413		52	4	101,8	69,4	93,4	53,9
63x2"	10	GR70002414		48	4	101,8	69,4	97,4	62,3
75x2"	10	GR70002415		28	2	118,8	111,6	150,1	62,5
75x2 1/2"	10	GR70002416		24	2	118,8	111,6	150,1	66,5
90x2	10	GR70002422							
90x2 1/2"	10	GR70002417		18	1	139,6	124,9	170,9	74
90x3"	10	GR70002418		17	1	139,6	124,9	170,9	76
110x3"	10	GR70002419		10	1	164,2	144,5	200,5	86
110x4"	10	GR70002420		9	1	164,2	144,5	200,5	92

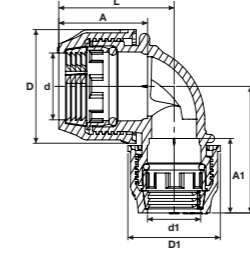
Kaplin Redüksiyon Dirsek
 Reducing Elbow

Çap Dia	Basınç Pn	Kod Code	Fiyat (Adet) Price (Pcs)	Koli Adet Box Pcs	Poşet İçi Adet Bag Pcs	A (mm)	D (mm)	A1 (mm)	D1 (mm)	L (mm)	L1 (mm)
25x20	10	GR70001800		330	15	36,5	46	34,2	37,5	48,3	46
32x25	10	GR70001801		200	10	43,6	56,5	36,5	46	56,6	49,5
40x32	10	GR70001802		110	5	49,2	68	43,6	56,5	65,7	60,1
50x40	10	GR70001803		64	4	59,2	84,4	49,2	68	79,7	69,7
63x50	10	GR70001804		40	4	69,4	101,8	59,2	84,4	94,25	84,05

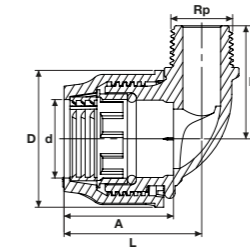
Kaplin Erkek Dirsek
 Male Elbow

Çap Dia	Basınç Pn	Kod Code	Fiyat (Adet) Price (Pcs)	Koli Adet Box Pcs	Poşet İçi Adet Bag/Pcs	D (mm)	A (mm)	L (mm)	L1 (mm)
20x1/2"	10	GR70002000		650	25	37,5	34,2	42,2	34,5
20x3/4"	10	GR70002001		600	25	37,5	34,2	44,7	35,5
20x1"	10	GR70002026				37,5	34,2	49,1	37,5
25x1/2"	10	GR70002002		420	15	46	36,5	45,7	37,8
25x3/4"	10	GR70002003		390	15	46	36,5	48,5	38,8
25x1"	10	GR70002004		360	15	46	36,5	51,4	40,8
32x3/4"	10	GR70002005		260	10	56,5	43,6	55,6	43,5
32x1"	10	GR70002006		240	10	56,5	43,6	58,1	47,5
32x1 1/4"	10	GR70002007		210	10	56,5	43,6	62,6	49,5
40x1"	10	GR70002008		140	5	68	49,2	61,7	54
40x1 1/4"	10	GR70002009		130	5	68	49,2	68,35	56
40x1 1/2"	10	GR70002010		120	5	68	49,2	69,7	58
50x1 1/4"	10	GR70002011		80	4	84,4	59,2	76,2	62
50x1 1/2"	10	GR70002012		80	4	84,4	59,2	80,2	64
50x2"	10	GR70002013		68	4	84,4	59,2	87,2	69
63x1 1/2"	10	GR70002014		52	4	101,8	69,4	90,4	69,3
63x2"	10	GR70002015		48	4	101,8	69,4	97,4	71,3
63x2 1/2"	10	GR70002016		40	4	101,8	69,4	106,65	84
75x2"	10	GR70002017		28	2	118,8	111,6	150,1	66,5
75x2 1/2"	10	GR70002018		26	2	118,8	111,6	150,1	62,5
90x2	10	GR70002019							
90x2 1/2"	10	GR70002020		18	1	139,6	124,9	170,9	74
90x3"	10	GR70002021		18	1	139,6	124,9	170,9	76
110x3"	10	GR70002023		10	1	164,2	144,5	200,5	86
110x4"	10	GR70002024		10	1	164,2	144,5	200,5	92
110x2 1/2"	10	GR70002025							

Not / Note

PP

VANA KUTULARI VALVE BOXES

ÜRETİM STANDARDI
PRODUCTION STANDARD | TS 13716

ÇAP / SIZE Ø6" - Ø16"



 **PIMTAŞ**[®]

Since 1977

Vana Kutusu
Valve Box



Çap Dia	Kod Code	Fiyat (Adet) Price (Pcs)	Palet/Adet Pallet/Pcs
6"	EX70003400		600

Vana Kutusu
Valve Box



Çap Dia	Kod Code	Fiyat (Adet) Price (Pcs)	Palet/Adet Pallet/Pcs
10"	EX70003401		300

Vana Kutusu
Valve Box (Standard)



Çap Dia	Kod Code	Fiyat (Adet) Price (Pcs)	Palet/Adet Pallet/Pcs
12"	EX70003500		168

Vana Kutusu
Valve Box (Jumbo)



Çap Dia	Kod Code	Fiyat (Adet) Price (Pcs)	Palet/Adet Pallet/Pcs
14"	EX70003501		116

Vana Kutusu
Vana Kutusu (Maxi Jumbo)



Çap Dia	Kod Code	Fiyat (Adet) Price (Pcs)	Palet/Adet Pallet/Pcs
16"	70003502		100

U-PVC / PP

PRİZ KOLYE ÜRÜN GRUBU CLAMP SADDLE PRODUCT LINE

ÜRETİM STANDARDI
PRODUCTION STANDARD | TS ISO 13460-1

ÇAP / SIZE Ø25 - Ø110



Not / Note

UH-PVC Priz Kolye
UH-PVC Clamp Saddle (4 Bolts)

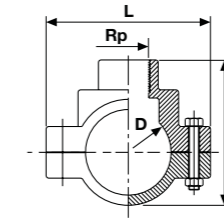

D (mm)	Rp Inch	Basınç PN	Kod Code	Fiyat (Adet) Price (Pcs)	Kg /Adet Kg/Pcs	Koli/Adet Box/Pcs	L (mm)	H (mm)
25	1/2"	16	52900250204		0,17	150	54	77
32	1/2"	16	52900320204		0,21	140	65	82
32	3/4"	16	52900320254		0,21	140	65	82
40	1/2"	16	52900400204		0,25	130	74	82
40	3/4"	16	52900400254		0,25	130	74	82
40	1"	16	52900400324		0,25	130	74	82
50	1/2"	16	52900500204		0,27	40	84	85
50	3/4"	16	52900500254		0,27	40	84	85
50	1"	16	52900500324		0,27	40	84	85
63	1/2"	16	52900630202		0,56	30	120	106
63	3/4"	16	52900630252		0,55	30	120	106
63	1"	16	52900630322		0,55	30	120	106
75	1/2"	16	52900750202		0,64	30	133	118
75	3/4"	16	52900750252		0,63	30	133	118
75	1"	16	52900750322		0,63	30	133	118
90	1/2"	16	52900900202		0,76	24	148	140
90	3/4"	16	52900900252		0,75	24	148	140
90	1"	16	52900900322		0,75	24	148	140
110	1/2"	16	52900110204		0,96	18	170	160
110	3/4"	16	51300110254		0,96	18	170	160
110	1"	16	51300110325		0,95	18	170	160

UH-PVC Biberon Kolye
UH-PVC Clamp Saddle With Hose Adaptor

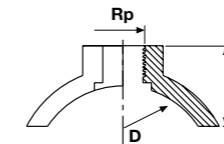

D (mm)	R Inch	Basınç PN	Kod Code	Fiyat (Adet) Price (Pcs)	Kg /Adet Kg/Pcs	Koli/Adet Box/Pcs	H (mm)
63	1/2"	16	53000630202		0,04	100	39
63	3/4"	16	53000630252		0,04	100	39
63	1"	16	53000630322		0,17	100	39
90	1/2"	16	53000900202		0,07	100	41
90	3/4"	16	53000900252		0,14	100	41
90	1"	16	53000900322		0,07	100	41

PP Priz Kolye
PP Clamp Saddle

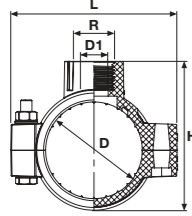

D (mm)	R (mm)	Basınç Pn	Kod Code	Fiyat (Adet) Price (Pcs)	Koli Adet Box Pcs	Poşet İçi Adet Bag/Pcs	d1 (mm)	L (mm)	H (mm)
25	1/2"	16	EX52901250202		180	1	16	54	52
25	3/4"	16	EX52901250252		180				
32	1/2"	16	EX52901320202		140	1	16	78	62
32	3/4"	16	EX52901320252		140	1	21	78	62
40	1/2"	16	EX52901400202		130	1	16	80	68
40	3/4"	16	EX52901400252		130	1	21	80	68
40	1"	16	EX52901400322		130	1	27	80	68
50	1/2"	16	EX52901500202		120	1	16	84	81
50	3/4"	16	EX52901500252		120	1	21	84	81
50	1"	16	EX52901500322		120	1	27	84	81
63	1/2"	16	EX52901630202		50	1	16	98	93
63	3/4"	16	EX52901630252		50	1	21	98	93
63	1"	16	EX52901630322		50	1	27	98	93
63	1 1/4"	16	EX52901630402				35	98	93
63	1 1/2"	16	EX52901630502				42	98	93
75	1/2"	16	EX52901750202		35	1	16	117	102
75	3/4"	16	EX52901750252		35	1	21	117	104
75	1"	16	EX52901750322		35	1	27	117	107
75	1 1/4"	16	EX52901750402		35	1	35	117	109
75	1 1/2"	16	EX52901750502		30	1	42	117	109
75	2"	16	EX52901750632		30	1	53	117	111
90	1/2"	16	EX52901900202		25	1	16	128	116
90	3/4"	16	EX52901900252		25	1	21	128	118
90	1"	16	EX52901900322		25	1	27	128	121
90	1 1/4"	16	EX52901900402		25	1	35	128	123
90	1 1/2"	16	EX52901900502		25	1	42	128	123
90	2"	16	EX52901900632		25	1	53	128	126
110	1/2"	16	EX5290110202		20	1	15	146	150
110	3/4"	16	EX5290110252		20	1	20	146	150
110	1"	16	EX5290110322		20	1	26	146	150
110	1 1/4"	16	EX5290110402		20	1	35	146	150
110	1 1/2"	16	EX5290110502		20	1	41	146	150
110	2"	16	EX5290110632		20	1	51	146	150
125	1/2"	16	EX52901125202		18	1	15	166	169
125	3/4"	16	EX52901125252		18	1	20	166	169
125	1"	16	EX52901125322		18	1	26	166	169
125	1 1/4"	16	EX52901125402		18	1	35	166	169
125	1 1/2"	16	EX52901125502		18	1	41	166	169
125	2"	16	EX52901125632		18	1	50	166	169
140	1/2"	16	EX52901140202		15	1	18	178	191
140	3/4"	16	EX52901140252		15	1	24	178	191
140	1"	16	EX52901140322		15	1	30	178	191
140	1 1/4"	16	EX52901140402		15	1	38	178	191
140	1 1/2"	16	EX52901140502		15	1	45	178	191
140	2"	16	EX52901140632		15	1	50	178	191
160	1/2"	16	EX52901160202		9	1	18	216	215
160	3/4"	16	EX52901160252		9	1	24	216	215
160	1"	16	EX52901160322		9	1	30	216	215
160	1 1/4"	16	EX52901160402		9	1	38	216	215
160	1 1/2"	16	EX52901160502		9	1	45	216	215
160	2"	16	EX52901160632		9	1	50	216	215
200	3/4"	16	EX52901200252				24	262	245
200	1"	16	EX52901200322				30	262	245
200	1 1/4"	16	EX52901200402				38	262	245
200	1 1/2"	16	EX52901200502		9	1	45	262	245
200	2"	16	EX52901200632		9	1	50	262	245

PP Metal Yüzlü Priz Kolye
PP Clamp Saddle with Reinforcing Ring

YENİ / NEW

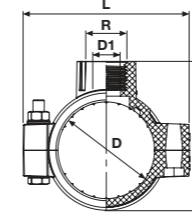

D (mm)	R (mm)	Basınç Pn	Kod Code	Fiyat (Adet) Price (Pcs)	Koli Adet Box Pcs	Poşet İçi Adet Bag/Pcs	d1 (mm)	L (mm)	H (mm)
25	1/2"	16	EX57700025202		180	1	16	54	52
25	3/4"	16	EX57700025252		180				
32	1/2"	16	EX57700032202		140	1	16	78	62
32	3/4"	16	EX57700032252		140	1	21	78	62
40	1/2"	16	EX57700040202		130	1	16	80	68
40	3/4"	16	EX57700040252		130	1	21	80	68
40	1"	16	EX57700040322		130	1	27	80	68
50	1/2"	16	EX57700050202		120	1	16	84	81
50	3/4"	16	EX57700050252		120	1	21	84	81
50	1"	16	EX57700050322		120	1	27	84	81
63	1/2"	16	EX57700063202		50	1	16	98	93
63	3/4"	16	EX57700063252		50	1	21	98	93
63	1"	16	EX57700063322		50	1	27	98	93
63	1 1/4"	16	EX57700063402				35	98	93
63	1 1/2"	16	EX57700063502				42	98	93
75	1/2"	16	EX57700075202		35	1	16	117	102
75	3/4"	16	EX57700075252		35	1	21	117	104
75	1"	16	EX57700075322		35	1	27	117	107
75	1 1/4"	16	EX57700075402		35	1	35	117	109
75	1 1/2"	16	EX57700075502		30	1	42	117	109
75	2"	16	EX57700075632		30	1	53	117	111
90	1/2"	16	EX57700090202		25	1	16	128	116
90	3/4"	16	EX57700090252		25	1	21	128	118
90	1"	16	EX57700090322		25	1	27	128	121
90	1 1/4"	16	EX57700090402		25	1	35	128	123
90	1 1/2"	16	EX57700090502		25	1	42	128	123
90	2"	16	EX57700090632		25	1	53	128	126
110	1/2"	16	EX57700110202		20	1	15	146	150
110	3/4"	16	EX57700110252		20	1	20	146	150
110	1"	16	EX57700110322		20	1	26	146	150
110	1 1/4"	16	EX57700110402		20	1	35	146	150
110	1 1/2"	16	EX57700110502		20	1	41	146	150
110	2"	16	EX57700110632		20	1	51	146	150
125	1/2"	16	EX57700125202		18	1	15	166	169
125	3/4"	16	EX57700125252		18	1	20	166	169
125	1"	16	EX57700125322		18	1	26	166	169
125	1 1/4"	16	EX57700125402		18	1	35	166	169
125	1 1/2"	16	EX57700125502		18	1	41	166	169
125	2"	16	EX57700125632		18	1	50	166	169
140	1/2"	16	EX57700140202		15	1	18	178	191
140	3/4"	16	EX57700140252		15	1	24	178	191
140	1"	16	EX57700140322		15	1	30	178	191
140	1 1/4"	16	EX57700140402		15	1	38	178	191
140	1 1/2"	16	EX57700140502		15	1	45	178	191
140	2"	16	EX57700140632		15	1	50	178	191
160	1/2"	16	EX57700160202		9	1	18	216	215
160	3/4"	16	EX57700160252		9	1	24	216	215
160	1"	16	EX57700160322		9	1	30	216	215
160	1 1/4"	16	EX57700160402		9	1	38	216	215
160	1 1/2"	16	EX57700160502		9	1	45	216	215
160	2"	16	EX57700160632		9	1	50	216	215
200	3/4"	16	EX57700200252				24	262	245
200	1"	16	EX57700200322				30	262	245
200	1 1/4"	16	EX57700200402				38	262	245
200	1 1/2"	16	EX57700200502		9	1	45	262	245
200	2"	16	EX57700200632		9	1	50	262	245

PP Çift Çıkışlı Civatalı Priz Kolye

PP Both Sides Socketed Clamp Saddle With Screws

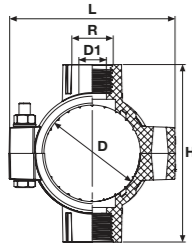

D (mm)	R (mm)	R1 (mm)	Basınç Pn	Kod Code	Fiyat (Adet) Price (Pcs)	Koli Adet Box Pcs	Poşet İçi Adet Bag/Pcs	L (mm)	H (mm)
25	1/2"	1/2"	16	EX52911025020202				54	52
25	3/4"	3/4"	16	EX52911025025202					
32	1/2"	1/2"	16	EX52911032020202		140	1	54	52
32	3/4"	3/4"	16	EX52911032025252		140		54	82
40	1/2"	1/2"	16	EX52911040020202		130	1	78	82
40	3/4"	3/4"	16	EX52911040025252		130	1	80	88
40	1"	1"	16	EX52911040032322		130	1	80	88
50	1/2"	1/2"	16	EX52911050020202		120	1	80	88
50	3/4"	3/4"	16	EX52911050025252		120	1	84	101
50	1"	1"	16	EX52911050032322		120	1	84	101
63	1/2"	1/2"	16	EX52911063020202		50	1	98	114
63	3/4"	3/4"	16	EX52911063025252		50	1	98	114
63	1"	1"	16	EX52911063032322		50	1	98	114
63	1 1/4"	1 1/4"	16	EX52911063040402				98	114
63	1 1/2"	1 1/2"	16	EX52911063050502				117	117
75	1/2"	1/2"	16	EX52911075020202		35	1	117	118
75	3/4"	3/4"	16	EX52911075025252		35	1	117	129
75	1"	1"	16	EX52911075032322		35	1	117	129
75	1 1/4"	1 1/4"	16	EX52911075040402		35	1	117	129
75	1 1/2"	1 1/2"	16	EX52911075050502		35	1	117	129
75	2"	2"	16	EX52911075063632		30	1	117	111
90	1/2"	1/2"	16	EX52911090020202		25	1	128	131
90	3/4"	3/4"	16	EX52911090025252		25	1	128	134
90	1"	1"	16	EX52911090032322		25	1	128	141
90	1 1/4"	1 1/4"	16	EX52911090040402		25	1	128	143
90	1 1/2"	1 1/2"	16	EX52911090050502		25	1	128	143
90	2"	2"	16	EX52911090063632		25	1	128	146
110	1/2"	1/2"	16	EX52911110020202		20	1	146	173
110	3/4"	3/4"	16	EX52911110025252		20	1	146	173
110	1"	1"	16	EX52911110032322		20	1	146	173
110	1 1/4"	1 1/4"	16	EX52911110040402		20	1	146	173
110	1 1/2"	1 1/2"	16	EX52911110050502		20	1	146	173
110	2"	2"	16	EX52911110063632		20	1	146	173
125	1/2"	1/2"	16	EX52911125020202		18	1	166	193
125	3/4"	3/4"	16	EX52911125025252		18	1	166	193
125	1"	1"	16	EX52911125032322		18	1	166	193
125	1 1/4"	1 1/4"	16	EX52911125040402		18	1	166	193
125	1 1/2"	1 1/2"	16	EX52911125050502		18	1	166	193
125	2"	2"	16	EX52911125063632		18	1	166	193
140	1/2"	1/2"	16	EX52911140020202		15	1	178	216
140	3/4"	3/4"	16	EX52911140025252		15	1	178	216
140	1"	1"	16	EX52911140032322		15	1	178	216
140	1 1/4"	1 1/4"	16	EX52911140040402		15	1	178	216
140	1 1/2"	1 1/2"	16	EX52911140050502		15	1	178	216
140	2"	2"	16	EX52911140063632		15	1	178	216
160	1/2"	1/2"	16	EX52911160020202		9	1	216	230
160	3/4"	3/4"	16	EX52911160025252		9	1	216	230
160	1"	1"	16	EX52911160032322		9	1	216	230
160	1 1/4"	1 1/4"	16	EX52911160040402		9	1	216	230
160	1 1/2"	1 1/2"	16	EX52911160050502		9	1	216	230
160	2"	2"	16	EX52911160032632		9	1	216	230
200	3/4"	3/4"	16	EX52911120025252			1	262	230
200	1"	1"	16	EX52911120032322			1	262	230
200	1 1/4"	1 1/4"	16	EX52911120040402			1	262	230
200	1 1/2"	1 1/2"	16	EX52911120050502		9	1	262	230
200	2"	2"	16	EX52911120063632		9	1	262	230

PP Çift Çıkışlı Metal Yüzüklü Priz Kolye

PP Both Sides Socketed Clamp Saddle With Reinforcing Ring

YENİ / NEW

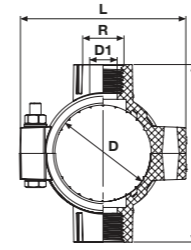

D (mm)	R (mm)	R1 (mm)	Basınç Pn	Kod Code	Fiyat (Adet) Price (Pcs)	Koli Adet Box Pcs	Poşet İçi Adet Bag/Pcs	L (mm)	H (mm)
25	1/2"	1/2"	16	EXBS57700025202		140		54	52
25	3/4"	3/4"	16	EXBS57700025252		140			
32	1/2"	1/2"	16	EXBS57700032202		130	1	54	52
32	3/4"	3/4"	16	EXBS57700032252		130		54	82
40	1/2"	1/2"	16	EXBS57700040202		130	1	78	82
40	3/4"	3/4"	16	EXBS57700040252		120	1	80	88
40	1"	1"	16	EXBS57700040322		120	1	80	88
50	1/2"	1/2"	16	EXBS57700050202		120	1	80	88
50	3/4"	3/4"	16	EXBS57700050252		50	1	84	101
50	1"	1"	16	EXBS57700050322		50	1	84	101
63	1/2"	1/2"	16	EXBS57700063202			1	98	114
63	3/4"	3/4"	16	EXBS57700063252			1	98	114
63	1"	1"	16	EXBS57700063322			1	98	114
63	1 1/4"	1 1/4"	16	EXBS57700063402		35		98	114
63	1 1/2"	1 1/2"	16	EXBS57700063502		35		117	117
75	1/2"	1/2"	16	EXBS57700075202		35	1	117	118
75	3/4"	3/4"	16	EXBS57700075252		35	1	117	129
75	1"	1"	16	EXBS57700075322		35	1	117	129
75	1 1/4"	1 1/4"	16	EXBS57700075402		30	1	117	129
75	1 1/2"	1 1/2"	16	EXBS57700075502		25	1	117	129
75	2"	2"	16	EXBS57700075632		25	1	117	111
90	1/2"	1/2"	16	EXBS57700090202		25	1	128	131
90	3/4"	3/4"	16	EXBS57700090252		25	1	128	134
90	1"	1"	16	EXBS57700090322		25	1	128	141
90	1 1/4"	1 1/4"	16	EXBS57700090402		25	1	128	143
90	1 1/2"	1 1/2"	16	EXBS57700090502		20	1	128	143
90	2"	2"	16	EXBS57700090632		20	1	128	146
110	1/2"	1/2"	16	EXBS57700110202		20	1	146	173
110	3/4"	3/4"	16	EXBS57700110252		20	1	146	173
110	1"	1"	16	EXBS57700110322		20	1	146	173
110	1 1/4"	1 1/4"	16	EXBS57700110402		20	1	146	173
110	1 1/2"	1 1/2"	16	EXBS57700110502		18	1	146	173
110	2"	2"	16	EXBS57700110632		18	1	146	173
125	1/2"	1/2"	16	EXBS57700125202		18	1	166	193
125	3/4"	3/4"	16	EXBS57700125252		18	1	166	193
125	1"	1"	16	EXBS57700125322		18	1	166	193
125	1 1/4"	1 1/4"	16	EXBS57700125402		18	1	166	193
125	1 1/2"	1 1/2"	16	EXBS57700125502		15	1	166	193
125	2"	2"	16	EXBS57700125632		15	1	166	193
140	1/2"	1/2"	16	EXBS57700140202		15	1	178	216
140	3/4"	3/4"	16	EXBS57700140252		15	1	178	216
140	1"	1"	16	EXBS57700140322		15	1	178	216
140	1 1/4"	1 1/4"	16	EXBS57700140402		15	1	178	216
140	1 1/2"	1 1/2"	16	EXBS57700140502		9	1	178	216
140	2"	2"	16	EXBS57700140632		9	1	178	216
160	1/2"	1/2"	16	EXBS57700160202		9	1	216	230
160	3/4"	3/4"	16	EXBS57700160252		9	1	216	230
160	1"	1"	16	EXBS57700160322		9	1	216	230
160	1 1/4"	1 1/4"	16	EXBS57700160402		9	1	216	230
160	1 1/2"	1 1/2"	16	EXBS57700160502			1	216	230
160	2"	2"	16	EXBS57700160632			1	216	230
200	3/4"	3/4"	16	EXBS57700200252			1	262	230
200	1"	1"	16	EXBS57700200322		9	1	262	230
200	1 1/4"	1 1/4"	16	EXBS57700200402		9	1	262	230
200	1 1/2"	1 1/2"	16	EXBS57700200502		6	1	262	230
200	2"	2"	16	EXBS57700200632		6	1	262	230

Kaplin Çıkışlı Priz Kolye
Coupling Outlet Clamp Saddle

YENİ / NEW

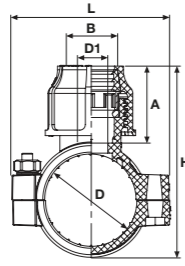

D (mm)	B (mm)	Basınç Pn	Kod Code	Fiyat (Adet) Price (Pcs)	Koli Adet Box Pcs	Poşet İçi Adet Bag Pcs	D1 (mm)	L (mm)	A (mm)	H (mm)
25	20	16	EX57800025202				15	69	37	71
25	25	16	EX57800025252				15	69	42	77
32	20	16	EX57800032202				15	69	37	80
32	25	16	EX57800032252				20	69	42	85
40	20	16	EX57800040202				15	70	37	88
40	25	16	EX57800040252				20	70	42	93
50	20	16	EX57800050202				15	86	37	102
50	25	16	EX57800050252				19	86	42	105
50	32	16	EX57800050322				25	86	47	111
63	20	16	EX57800063202				15	100	37	114
63	25	16	EX57800063252				20	100	42	119
63	32	16	EX57800063322				25	100	47	125
63	40	16	EX57800063402				32	100	59	137
75	20	16	EX57800075202				15	115	37	127
75	25	16	EX57800075252				20	115	42	133
75	32	16	EX57800075322				25	115	47	141
75	40	16	EX57800075402				32	115	59	155
75	50	16	EX57800075502				37	115	68	164
90	20	16	EX57800090202				15	132	37	145
90	25	16	EX57800090252				20	132	42	149
90	32	16	EX57800090322				25	132	47	157
90	40	16	EX57800090402				32	132	59	171
90	50	16	EX57800090502				40	132	68	180
110	20	16	EX57800110202				15	154	37	164
110	25	16	EX57800110252				20	154	42	168
110	32	16	EX57800110322				25	154	47	177
110	40	16	EX57800110402				32	154	59	190
110	50	16	EX57800110502				40	154	68	199

Çift Taraf Kaplin Çıkışlı Priz Kolye
Both Sides Coupling Outlet Clamp Saddle

YENİ / NEW

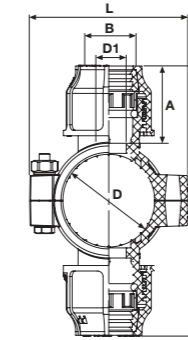

D (mm)	B (mm)	Basınç Pn	Kod Code	Fiyat (Adet) Price (Pcs)	Koli Adet Box Pcs	Poşet İçi Adet Bag/Pcs	D1 (mm)	L (mm)	A (mm)	H (mm)
25	20	16	EXBS57800025202				15	69	37	108,2
25	25	16	EXBS57800025252				15	69	42	118,7
32	20	16	EXBS57800032202				15	69	37	116,6
32	25	16	EXBS57800032252				20	69	42	127,1
40	20	16	EXBS57800040202				15	70	37	125,0
40	25	16	EXBS57800040252				20	70	42	135,5
50	20	16	EXBS57800050202				15	86	37	141,2
50	25	16	EXBS57800050252				19	86	42	146,7
50	32	16	EXBS57800050322				25	86	47	158,8
63	20	16	EXBS57800063202				15	100	37	151,7
63	25	16	EXBS57800063252				20	100	42	162,2
63	32	16	EXBS57800063322				25	100	47	172,8
63	40	16	EXBS57800063402				32	100	59	195,0
75	20	16	EXBS57800075202				15	115	37	162,2
75	25	16	EXBS57800075252				20	115	42	174,7
75	32	16	EXBS57800075322				25	115	47	188,3
75	40	16	EXBS57800075402				32	115	59	216,9
75	50	16	EXBS57800075502				37	115	68	234,9
90	20	16	EXBS57800090202				15	132	37	183,2
90	25	16	EXBS57800090252				20	132	42	191,7
90	32	16	EXBS57800090322				25	132	47	204,3
90	40	16	EXBS57800090402				32	132	59	233,9
90	50	16	EXBS57800090502				40	132	68	251,5
110	20	16	EXBS57800110202				15	154	37	202,2
110	25	16	EXBS57800110252				20	154	42	210,7
110	32	16	EXBS57800110322				25	154	47	224,8
110	40	16	EXBS57800110402				32	154	59	251,5
110	50	16	EXBS57800110502				40	154	68	269,5

Hortum Adaptör Çıkışlı Priz Kolye
 Hose Adaptor Outlet Clamp Saddle

YENİ / NEW

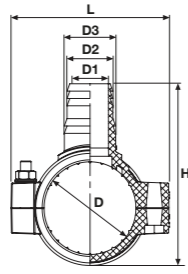

D (mm)	D2 (mm)	Basınç Pn	Kod Code	Fiyat (Adet) Price (Pcs)	Koli Adet Box Pcs	Poşet İçi Adet Bag Pcs	D1 (mm)	D3 (mm)	L (mm)	H (mm)
25	16	16	EX57900025162				12	18	69	61
25	20	16	EX57900025202				15	22	69	63
25	25	16	EX57900025252				20	28	69	70
32	16	16	EX57900032162				12	18	69	69
32	20	16	EX57900032202				15	22	69	71
32	25	16	EX57900032252				20	28	69	78
32	32	16	EX57900032322				25	34	69	85
40	16	16	EX57900040162				12	18	70	77
40	20	16	EX57900040202				15	22	70	79
40	25	16	EX57900040252				20	28	70	86
40	32	16	EX57900040322				25	34	70	93
50	16	16	EX57900050162				12	18	86	91
50	20	16	EX57900050202				15	22	86	92
50	25	16	EX57900050252				20	28	86	99
50	32	16	EX57900050322				25	34	85	106
63	16	16	EX57900063162				12	18	100	105
63	20	16	EX57900063202				15	22	100	106
63	25	16	EX57900063252				20	28	100	112
63	32	16	EX57900063322				25	34	100	120
75	16	16	EX57900075162				12	18	115	118
75	20	16	EX57900075202				15	22	115	120
75	25	16	EX57900075252				20	28	115	126
75	32	16	EX57900075322				25	34	115	137
90	16	16	EX57900090162				12	18	132	135
90	20	16	EX57900090202				15	22	132	136
90	25	16	EX57900090252				20	28	132	143
90	32	16	EX57900090322				25	34	132	151
110	16	16	EX57900110162				12	18	154	155
110	20	16	EX57900110202				15	22	154	157
110	25	16	EX57900110252				20	28	154	163
110	32	16	EX57900110322				25	34	154	173

Çift Taraf Hortum Adaptör Çıkışlı Priz Kolye
 Both Sides Hose Adaptor Outlet Clamp Saddle

YENİ / NEW

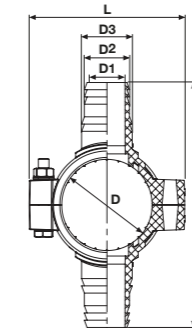

D (mm)	D2 (mm)	Basınç Pn	Kod Code	Fiyat (Adet) Price (Pcs)	Koli Adet Box Pcs	Poşet İçi Adet Bag/Pcs	D1 (mm)	D3 (mm)	L (mm)	H (mm)
25	16	16	EXBS57900025162				12	18	69	87
25	20	16	EXBS57900025202				15	22	69	91
25	25	16	EXBS57900025252				20	28	69	105
32	16	16	EXBS57900032162				12	18	69	95,4
32	20	16	EXBS57900032202				15	22	69	99,4
32	25	16	EXBS57900032252				20	28	69	113,4
32	32	16	EXBS57900032322				25	34	69	127,4
40	16	16	EXBS57900040162				12	18	70	103,8
40	20	16	EXBS57900040202				15	22	70	107,8
40	25	16	EXBS57900040252				20	28	70	121,8
40	32	16	EXBS57900040322				25	34	70	135,8
50	16	16	EXBS57900050162				12	18	86	119,0
50	20	16	EXBS57900050202				15	22	86	122,0
50	25	16	EXBS57900050252				20	28	86	136,0
50	32	16	EXBS57900050322				25	34	85	148,5
63	16	16	EXBS57900063162				12	18	100	133,0
63	20	16	EXBS57900063202				15	22	100	135,5
63	25	16	EXBS57900063252				20	28	100	147,0
63	32	16	EXBS57900063322				25	34	100	162,0
75	16	16	EXBS57900075162				12	18	115	145,0
75	20	16	EXBS57900075202				15	22	115	149,0
75	25	16	EXBS57900075252				20	28	115	161,5
75	32	16	EXBS57900075322				25	34	115	179,5
90	16	16	EXBS57900090162				12	18	132	163,2
90	20	16	EXBS57900090202				15	22	132	166,4
90	25	16	EXBS57900090252				20	28	132	179,0
90	32	16	EXBS57900090322				25	34	132	193,0
110	16	16	EXBS57900110162				12	18	154	183,5
110	20	16	EXBS57900110202				15	22	154	187,0
110	25	16	EXBS57900110252				20	28	154	199,5
110	32	16	EXBS57900110322				25	34	154	217,0

Geçmeli Priz Kolye
Click - Fit Clamp Saddle

YENİ / NEW

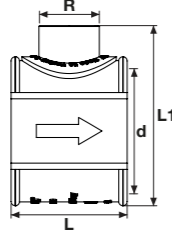

D (mm)	R (mm)	Basınç Pn	Kod Code	Fiyat (Adet) Price (Pcs)	Koli Adet Box Pcs	Poşet İçi Adet Bag/Pcs	L (mm)
32	1/2"	16	EX58000032202				47
32	3/4"	16	EX58000032252				47
40	1/2"	16	EX58000040202				47
40	3/4"	16	EX58000040252				47
50	1/2"	16	EX58000050202				68
50	3/4"	16	EX58000050252				68
50	1"	16	EX58000050322				68
63	1/2"	16	EX58000063202				69
63	3/4"	16	EX58000063252				69
63	1"	16	EX58000063322				69
75	1/2"	16	EX58000075202				69
75	3/4"	16	EX58000075252				69
75	1"	16	EX58000075322				69

Çift Taraf Geçmeli Priz Kolye
Both Sides Click - Fit Clamp Saddle

YENİ / NEW

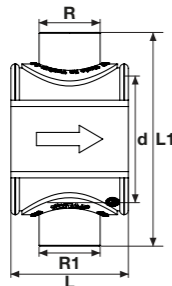

D (mm)	R (mm)	R1 (mm)	Basınç Pn	Kod Code	Fiyat (Adet) Price (Pcs)	Koli Adet Box Pcs	Poşet İçi Adet Bag/Pcs	L (mm)	L1 (mm)
32	1/2"	1/2"	16	EXBS58000032202				47	78,7
32	3/4"	3/4"	16	EXBS58000032252				47	78,7
40	1/2"	1/2"	16	EXBS58000040202				47	86,8
40	3/4"	3/4"	16	EXBS58000040252				47	86,8
50	1/2"	1/2"	16	EXBS58000050202				68	101,6
50	3/4"	3/4"	16	EXBS58000050252				68	102,6
50	1"	1"	16	EXBS58000050322				68	103,6
63	1/2"	1/2"	16	EXBS58000063202				69	105
63	3/4"	3/4"	16	EXBS58000063252				69	107
63	1"	1"	16	EXBS58000063322				69	115
75	1/2"	1/2"	16	EXBS58000075202				69	125,6
75	3/4"	3/4"	16	EXBS58000075252				69	125,6
75	1"	1"	16	EXBS58000075322				69	129,6

MANDALLI YAĞMURLAMA BORU ve EK PARÇALARI

LATCHED IRRIGATION PIPE AND FITTINGS

ÜRETİM STANDARDI

PRODUCTION STANDARD

TS EN 12201-2+A1

TS EN 12201-3+A1

ÇAP / SIZE Ø32 - Ø160



Mandallı Yağmurlama Borusu
 Latched Irrigation Pipe

Çap Dia	Kod Code (5 m)	Fiyat (Adet) Price (Pcs)	Çap Dia	Kod Code (6 m)	Fiyat (Adet) Price (Pcs)
50	DRP99000001		50	DRP99000001 6	
63	DRP99000002		63	DRP99000002 6	
75	DRP99000003		75	DRP99000003 6	
90	DRP99000004		90	DRP99000004 6	
110	DRP99000005		110	DRP99000005 6	
125	DRP99000006		125	DRP99000006 6	
140	DRP99000007		140	DRP99000007 6	
160	DRP99000008		160	DRP99000008 6	

PE Mandallı Redüksiyon
 PE Latched Reducer

Çap Dia	Kod Code	Fiyat (Adet) Price (Pcs)
75x63	DRP0000001	
90x63	DRP0000002	
90x75	DRP0000003	
110x63	DRP0000004	
110x75	DRP0000005	
110x90	DRP0000006	
125x63	DRP0000007	
125x75	DRP0000008	
125x90	DRP0000009	
125x110	DRP0000010	
140x75	DRP0000011	
140x90	DRP0000012	
140x110	DRP0000013	
140x125	DRP0000014	
160x90	DRP0000015	
160x110	DRP0000016	
160x125	DRP0000017	
160x140	DRP0000018	

PE Mandallı Ters Redüksiyon
 PE Latched ? Reducer

Çap Dia	Kod Code	Fiyat (Adet) Price (Pcs)
75x63	DRP0000019	
90x63	DRP0000020	
90x75	DRP0000021	
110x63	DRP0000022	
110x75	DRP0000023	
110x90	DRP0000024	
125x63	DRP0000025	
125x75	DRP0000026	
125x90	DRP0000027	
125x110	DRP0000028	
140x75	DRP0000029	
140x90	DRP0000030	
140x110	DRP0000031	
140x125	DRP0000032	
160x90	DRP0000033	
160x110	DRP0000034	
160x125	DRP0000035	
160x140	DRP0000036	

PE Mandallı İstavroz
 PE Latched Cross Type

Çap Dia	Kod Code	Fiyat (Adet) Price (Pcs)
75x63	DRP95000000	
75x75	DRP95000001	
90x63	DRP95000002	
90x75	DRP95000003	
90x90	DRP95000004	
110x50	DRP95000005	
110x63	DRP95000006	
110x75	DRP95000007	
110x90	DRP95000008	
110x110	DRP95000009	
125x63	DRP95000011	
125x75	DRP95000012	
125x90	DRP95000013	
125x110	DRP95000014	
125x125	DRP95000015	
140x75	DRP95000016	
140x90	DRP95000017	
140x110	DRP95000018	
140x125	DRP95000019	
140x140	DRP95000020	
160x75	DRP95000021	
160x90	DRP95000022	
160x110	DRP95000023	
160x125	DRP95000024	
160x140	DRP95000025	
160x160	DRP95000026	

PE Mandallı Te
 PE Latched Tee

Çap Dia	Kod Code	Fiyat (Adet) Price (Pcs)
50x50	DRP96000027	
63x63	DRP96000028	
75x63	DRP96000029	
75x75	DRP96000001	
90x50	DRP96000030	
90x63	DRP96000002	
90x75	DRP96000003	
90x90	DRP96000004	
110x50	DRP96000005	
110x63	DRP96000006	
110x75	DRP96000007	
110x90	DRP96000008	
110x110	DRP96000009	
125x50	DRP96000010	
125x63	DRP96000011	
125x75	DRP96000012	
125x90	DRP96000013	
125x110	DRP96000014	
125x125	DRP96000015	
140x75	DRP96000016	
140x90	DRP96000017	
140x110	DRP96000018	
140x125	DRP96000019	
140x140	DRP96000020	
160x75	DRP96000021	
160x90	DRP96000021	
160x110	DRP96000023	
160x125	DRP96000024	
160x140	DRP96000025	
160x160	DRP96000026	

PE Mandallı Dirsek
 PE Latched Elbow

Çap Dia	Kod Code	Fiyat (Adet) Price (Pcs)
50	DRP97000001	
63	DRP97000002	
75	DRP97000003	
90	DRP97000004	
110	DRP97000005	
125	DRP97000006	
140	DRP97000007	
160	DRP97000008	

PE Mandallı Abot
 PE Latched Hydrant

Çap Dia	Kod Code	Fiyat (Adet) Price (Pcs)
50	DRP93000000	
63	DRP93000001	
75	DRP93000002	
90	DRP93000003	
110	DRP93000004	

Küresel Hat Vanası
 Ball Line Valve

Çap Dia	Kod Code	Fiyat (Adet) Price (Pcs)
50	DRP76000001	
63	DRP76000002	
75	DRP76000003	
90	DRP76000004	
110	DRP76000005	
125	DRP76000006	

Yağmurlama Sprink Vanası
 Irrigation Sprink Valve

Çap Dia	Kod Code	Fiyat (Adet) Price (Pcs)
1"	240000322	

PVC Uzatma Borusu
 PVC Extension Pipe

Çap Dia (mm)	Uzunluk Length (cm)	Kod Code	Kod Code	Fiyat (Adet) Price (Pcs)
32	25	SD042156	DRP70000001	
32	35	SD042157	DRP70000002	
32	50	SD042158	DRP70000003	
32	60	SD042159	DRP70000004	
32	100	SD042160	DRP70000005	
32	150	SD042161	DRP70000006	

Sprinkler

Kod Code	Fiyat (Adet) Price (Pcs)
DRP75000001	



Kod Code	Fiyat (Adet) Price (Pcs)
DRP73000001	



Kod Code	Fiyat (Adet) Price (Pcs)
DRP72000001	



Kod Code	Fiyat (Adet) Price (Pcs)
DRP71000001	



Kod Code	Fiyat (Adet) Price (Pcs)
DRP74000001	

Conta
 O-ring

Çap Dia	Kod Code	Fiyat (Adet) Price (Pcs)
50	DRP97000001	
63	DRP97000002	
75	DRP97000003	
90	DRP97000004	
110	DRP97000005	
125	DRP97000006	
140	DRP97000007	
160	DRP97000008	

DAMLA SULAMA BORU

DRIP IRRIGATION PIPE

ÜRETİM STANDARTI
 PRODUCTION STANDARD | TS EN ISO 9261

ÇAP / SIZE Ø16 - Ø25





16 mm Yuvarlak Damla Sulama Borusu

16 mm Round Drip Irrigation Pipes

Çap Dia (mm)	Kod Code	Fiyat (Adet) Price (Pcs)	Et Kalınlığı Wall Thickness (mm)	Damlaticı Aralığı Dropping Range (cm)	Mt/Adet Mt/Roll	Debi (L/h) Flow (L/h)
16	EXDRP79000001		0,9	20	400	2/4/8
16	EXDRP79000002		0,9	25	400	2/4/8
16	EXDRP79000003		0,9	33	400	2/4/8
16	EXDRP79000004		0,9	40	400	2/4/8
16	EXDRP79000005		0,9	50	400	2/4/8
16	EXDRP79000006		0,9	60	400	2/4/8
16	EXDRP79000007		0,9	70	400	2/4/8
16	EXDRP79000008		0,9	75	400	2/4/8
16	EXDRP79000009		0,9	80	400	2/4/8
16	EXDRP79000010		0,9	90	400	2/4/8
16	EXDRP79000011		0,9	100	400	2/4/8

16 mm Yuvarlak Damla Sulama Borusu

16 mm Round Drip Irrigation Pipes

Çap Dia (mm)	Kod Code	Fiyat (Adet) Price (Pcs)	Et Kalınlığı Wall Thickness (mm)	Damlaticı Aralığı Dropping Range (cm)	Mt/Adet Mt/Roll	Debi (L/h) Flow (L/h)
16	EXDRP80000001		1,0	20	400	2/4/8
16	EXDRP80000002		1,0	25	400	2/4/8
16	EXDRP80000003		1,0	33	400	2/4/8
16	EXDRP80000004		1,0	40	400	2/4/8
16	EXDRP80000005		1,0	50	400	2/4/8
16	EXDRP80000006		1,0	60	400	2/4/8
16	EXDRP80000007		1,0	70	400	2/4/8
16	EXDRP80000008		1,0	75	400	2/4/8
16	EXDRP80000009		1,0	80	400	2/4/8
16	EXDRP80000010		1,0	90	400	2/4/8
16	EXDRP80000011		1,0	100	400	2/4/8



Yuvarlak Düz Sulama Borusu

Straight Drip Irrigation Pipes

Çap Dia (mm)	Kod Code	Fiyat (Adet) Price (Pcs)	Et Kalınlığı Wall Thickness (mm)	Mt/Adet Mt/Roll
16	EXDRP81000001		0,9	400
16	EXDRP81000002		1,0	400
16	EXDRP81000003		1,1	400
20	EXDRP81000004		1,0	300
20	EXDRP81000005		1,2	300
20	EXDRP81000006		1,5	300
25	EXDRP81000007		1,2	200
25	EXDRP81000008		1,5	200
25	EXDRP81000009		2,0	200

20 mm Yuvarlak Damla Sulama Borusu

20 mm Round Drip Irrigation Pipes

Çap Dia (mm)	Kod Code	Fiyat (Adet) Price (Pcs)	Et Kalınlığı Wall Thickness (mm)	Damlaticı Aralığı Dropping Range (cm)	Mt/Adet Mt/Roll	Debi (L/h) Flow (L/h)
20	EXDRP82000001		1,1	20	300	2/4/8
20	EXDRP82000002		1,1	25	300	2/4/8
20	EXDRP82000003		1,1	33	300	2/4/8
20	EXDRP82000004		1,1	40	300	2/4/8
20	EXDRP82000005		1,1	50	300	2/4/8
20	EXDRP82000006		1,1	60	300	2/4/8
20	EXDRP82000007		1,1	70	300	2/4/8
20	EXDRP82000008		1,1	75	300	2/4/8
20	EXDRP82000009		1,1	80	300	2/4/8
20	EXDRP82000010		1,1	90	300	2/4/8
20	EXDRP82000011		1,1	100	300	2/4/8



17 mm Yassı Damla Sulama Borusu (6 Mil)

17 mm Flat Drip Irrigation Pipes (6 Mil)

Çap Dia (mm)	Kod Code	Fiyat (Adet) Price (Pcs)	Et Kalınlığı Wall Thickness (mm)	Damlatıcı Aralığı Dropping Range (cm)	Mt/Adet Mt/Roll	Debi (L/h) Flow (L/h)
17	EXDRP83000001		0,15	20	2.500	1.6/2.2
17	EXDRP83000002		0,15	25	2.500	1.6/2.2
17	EXDRP83000003		0,15	33	2.500	1.6/2.2
17	EXDRP83000004		0,15	40	2.500	1.6/2.2
17	EXDRP83000005		0,15	50	2.500	1.6/2.2

17 mm Yassı Damla Sulama Borusu (8 Mil)

17 mm Flat Drip Irrigation Pipes (8 Mil)

Çap Dia (mm)	Kod Code	Fiyat (Adet) Price (Pcs)	Et Kalınlığı Wall Thickness (mm)	Damlatıcı Aralığı Dropping Range (cm)	Mt/Adet Mt/Roll	Debi (L/h) Flow (L/h)
17	EXDRP84000001		0,15	20	2.500	1.6/2.2
17	EXDRP84000002		0,15	25	2.500	1.6/2.2
17	EXDRP84000003		0,15	33	2.500	1.6/2.2
17	EXDRP84000004		0,15	40	2.500	1.6/2.2
17	EXDRP84000005		0,15	50	2.500	1.6/2.2

17 mm Yassı Damla Sulama Borusu (10 Mil)

17 mm Flat Drip Irrigation Pipes (10 Mil)

Çap Dia (mm)	Kod Code	Fiyat (Adet) Price (Pcs)	Et Kalınlığı Wall Thickness (mm)	Damlatıcı Aralığı Dropping Range (cm)	Mt/Adet Mt/Roll	Debi (L/h) Flow (L/h)
17	EXDRP85000001		0,25	20	1.800	1.6/2.2
17	EXDRP85000002		0,25	25	1.800	1.6/2.2
17	EXDRP85000003		0,25	33	1.800	1.6/2.2
17	EXDRP85000004		0,25	40	1.800	1.6/2.2
17	EXDRP85000005		0,25	50	1.800	1.6/2.2

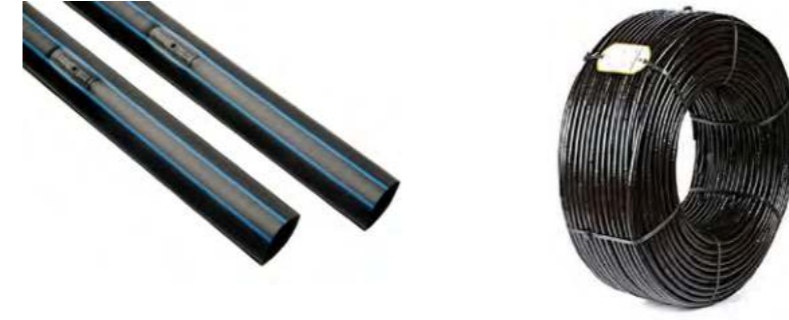

22 mm Yassı Damla Sulama Borusu (8 Mil)

22 mm Flat Drip Irrigation Pipes (8 Mil)

Çap Dia (mm)	Kod Code	Fiyat (Adet) Price (Pcs)	Et Kalınlığı Wall Thickness (mm)	Damlatıcı Aralığı Dropping Range (cm)	Mt/Adet Mt/Roll	Debi (L/h) Flow (L/h)
22	EXDRP86000001		0,20	20	1.800	1.6/2.2
22	EXDRP86000002		0,20	25	1.800	1.6/2.2
22	EXDRP86000003		0,20	33	1.800	1.6/2.2
22	EXDRP86000004		0,20	40	1.800	1.6/2.2
22	EXDRP86000005		0,20	50	1.800	1.6/2.2

22 mm Yassı Damla Sulama Borusu (12 Mil)

22 mm Flat Drip Irrigation Pipes (12 Mil)

Çap Dia (mm)	Kod Code	Fiyat (Adet) Price (Pcs)	Et Kalınlığı Wall Thickness (mm)	Damlatıcı Aralığı Dropping Range (cm)	Mt/Adet Mt/Roll	Debi (L/h) Flow (L/h)
22	EXDRP87000001		0,30	20	1.200	1.6/2.2
22	EXDRP87000002		0,30	25	1.200	1.6/2.2
22	EXDRP87000003		0,30	33	1.200	1.6/2.2
22	EXDRP87000004		0,30	40	1.200	1.6/2.2
22	EXDRP87000005		0,30	50	1.200	1.6/2.2

25 mm Yassı Damla Sulama Borusu (12 Mil)

25 mm Flat Drip Irrigation Pipes (12 Mil)

Çap Dia (mm)	Kod Code	Fiyat (Adet) Price (Pcs)	Et Kalınlığı Wall Thickness (mm)	Damlatıcı Aralığı Dropping Range (cm)	Mt/Adet Mt/Roll	Debi (L/h) Flow (L/h)
25	EXDRP88000001		0,30	20	1.000	1.6/2.2
25	EXDRP88000002		0,30	25	1.000	1.6/2.2
25	EXDRP88000003		0,30	33	1.000	1.6/2.2
25	EXDRP88000004		0,30	40	1.000	1.6/2.2
25	EXDRP88000005		0,30	50	1.000	1.6/2.2

Not / Note

DAMLA SULAMA ÜRÜNLERİ

DRIP IRRIGATION PRODUCT LINE

ÜRETİM STANDARDI
PRODUCTION STANDARD | TS EN ISO 9261

ÇAP / SIZE Ø16 - Ø110



 **PIMTAŞ**[®]

Since 1977

Kurtağzı Mini Vana

Barbed Mini Valve



Çap Dia (mm)	Kod Code	Fiyat (Adet) Price (Pcs)	Koli Adet Box Pcs	Kg/Koli Kg/Box
16x16	EXDRP1000001		400	7,430
20x16	EXDRP1000002		350	6,900
20x20	EXDRP1000003		350	7,140

Kurtağzı Conta Çıkış Mini Vana

Barbed Offtake Mini Valve



Çap Dia (mm)	Kod Code	Fiyat (Adet) Price (Pcs)	Koli Adet Box Pcs	Kg/Koli Kg/Box
16x16	EXDRP2000001		400	8,000
20x20	EXDRP2000002		300	7,470

Kurtağzı Dış Dişli Mini Vana

Male Thread Barbed Mini Valve



Çap Dia (mm)	Kod Code	Fiyat (Adet) Price (Pcs)	Koli Adet Box Pcs	Kg/Koli Kg/Box
16x1/2"	EXDRP3000001		400	8,450
16x3/4"	EXDRP3000002		350	8,300
20x1/2"	EXDRP3000003		350	9,350
20x3/4"	EXDRP3000004		350	8,500

Kurtağzı Somunlu Mini Vana

Mini Valve Barbed For Tape & GR

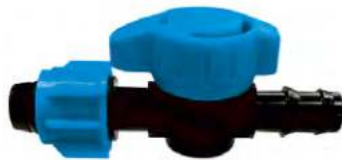

Çap Dia (mm)	Kod Code	Fiyat (Adet) Price (Pcs)	Koli Adet Box Pcs	Kg/Koli Kg/Box
17x16	EXDRP4000001		300	7,450

Somunlu Dış Dişli Mini Vana

Male Thread Mini Valve -Tape & GR



Çap Dia (mm)	Kod Code	Fiyat (Adet) Price (Pcs)	Koli Adet Box Pcs	Kg/Koli Kg/Box
17x1/2"	EXDRP5000001		300	7,950
17x3/4"	EXDRP5000002		300	8,790

Somunlu Conta Çıkış Mini Vana

Mini Valve Offtake For Tape & GR



Çap Dia (mm)	Kod Code	Fiyat (Adet) Price (Pcs)	Koli Adet Box Pcs	Kg/Koli Kg/Box
17x16	EXDRP6000001		300	7,650

Kurtağzı Yüüklü Mini Vana

Barbed Mini Valve With Ring



Çap Dia (mm)	Kod Code	Fiyat (Adet) Price (Pcs)	Koli Adet Box Pcs	Kg/Koli Kg/Box
17x16	EXDRP7000001		350	7,500

Yüüklü Conta Çıkış Mini Vana

Mini Valve Offtake With Ring



Çap Dia (mm)	Kod Code	Fiyat (Adet) Price (Pcs)	Koli Adet Box Pcs	Kg/Koli Kg/Box
17x16	EXDRP8000001		350	7,900

Yüüklü Contasız Bağlantı Mini Vana

Mini Valve With Ring (Without Gasket)



Çap Dia (mm)	Kod Code	Fiyat (Adet) Price (Pcs)	Koli Adet Box Pcs	Kg/Koli Kg/Box
17x12	EXDRP9000001		300	-

Somunlu Contasız Bağlantı Mini Vana

Mini Valve For Tape & GR (Without Ring)



Çap Dia (mm)	Kod Code	Fiyat (Adet) Price (Pcs)	Koli Adet Box Pcs	Kg/Koli Kg/Box
17x12	EXDRP10000001		250	7,850

Yüüklü Dış Dişli Mini Vana

Mini Valve Thread Male - With Ring



Çap Dia (mm)	Kod Code	Fiyat (Adet) Price (Pcs)	Koli Adet Box Pcs	Kg/Koli Kg/Box
17x1/2"	EXDRP11000001		350	8,350
17x3/4"	EXDRP11000002		300	8,450

Yüüklü Layflat Mini Vana

Mini Valve Layflat For Tape & GR



Çap Dia (mm)	Kod Code	Fiyat (Adet) Price (Pcs)	Koli Adet Box Pcs	Kg/Koli Kg/Box
17	EXDRP12000001		200	-

Somunlu Layflat Mini Vana

Mini Valve Layflat With Ring



Çap Dia (mm)	Kod Code	Fiyat (Adet) Price (Pcs)	Koli Adet Box Pcs	Kg/Koli Kg/Box
17	EXDRP13000001		200	-

Kurtağzı Layflat Mini Vana

Mini Valve Layflat Barbed



Çap Dia (mm)	Kod Code	Fiyat (Adet) Price (Pcs)	Koli Adet Box Pcs	Kg/Koli Kg/Box
16	EXDRP14000001		250	-

Kurtağzı Ekleme Nipeli

Barbed Nipple



Çap Dia (mm)	Kod Code	Fiyat (Adet) Price (Pcs)	Koli Adet Box Pcs	Kg/Koli Kg/Box
16x16	EXDRP15000001		2000	6,050
20x16	EXDRP15000003		1000	4,320
20x20	EXDRP15000002		1000	4,600

Kurtağzı Conta Çıkış Nipeli

Barbed With Gasket Nipple



Çap Dia (mm)	Kod Code	Fiyat (Adet) Price (Pcs)	Koli Adet Box Pcs	Kg/Koli Kg/Box
16x16	EXDRP16000001		2000	6,250
20x20	EXDRP16000002		1000	4,950

Kurtağzı Redüksiyon Nipeli

Barbed Reduction



Çap Dia (mm)	Kod Code	Fiyat (Adet) Price (Pcs)	Koli Adet Box Pcs	Kg/Koli Kg/Box
20x16	EXDRP17000001		-	-

Kurtağzı Kör Tapa

Barbed Plug



Çap Dia (mm)	Kod Code	Fiyat (Adet) Price (Pcs)	Koli Adet Box Pcs	Kg/Koli Kg/Box
16	EXDRP18000001		2000	6,650
20	EXDRP18000002		1000	3,900

Gözlük Tapa

End Clamp Ring



Çap Dia (mm)	Kod Code	Fiyat (Adet) Price (Pcs)	Koli Adet Box Pcs	Kg/Koli Kg/Box
16	EXDRP19000001		2500	6,450
20	EXDRP19000002		1500	6,800

Kurtağzı Te

Barbed Tee



Çap Dia (mm)	Kod Code	Fiyat (Adet) Price (Pcs)	Koli Adet Box Pcs	Kg/Koli Kg/Box
16x16x16	EXDRP20000001		1000	5,950
16x20x16	EXDRP20000002		1000	5,680
20x16x20	EXDRP20000003		750	5,400
20x20x20	EXDRP20000004		500	3,800

Kurtağzı Dirsek

Barbed Elbow



Çap Dia (mm)	Kod Code	Fiyat (Adet) Price (Pcs)	Koli Adet Box Pcs	Kg/Koli Kg/Box
16x16	EXDRP21000001		1500	6,100
20x20	EXDRP21000002		1000	5,300

Sabitleme Kazığı

Spike



Çap Dia (mm)	Kod Code	Fiyat (Adet) Price (Pcs)	Koli Adet Box Pcs	Kg/Koli Kg/Box
Long	EXDRP22000001		300	7,050
Short	EXDRP22000002		300	6,150

Somunlu Ekleme Nipeli

Tape & GR Nipple



Çap Dia (mm)	Kod Code	Fiyat (Adet) Price (Pcs)	Koli Adet Box Pcs	Kg/Koli Kg/Box
16x16	EXDRP23000001		600	9,370
17x17	EXDRP23000002		600	9,370
22x22	EXDRP23000003		300	6,980
25x25	EXDRP23000004		300	8,120

Somunlu Dış Dişli Ekleme Nipeli

Tape & GR Male Nipple



Çap Dia (mm)	Kod Code	Fiyat (Adet) Price (Pcs)	Koli Adet Box Pcs	Kg/Koli Kg/Box
22x1/2	EXDRP24000001		500	7,430
22x3/4	EXDRP24000002		500	-
25x1/2	EXDRP24000003		500	-
25x3/4	EXDRP24000004		500	-

Somunlu Conta Çıkış Nipeli

Tape & GR Offtake Nipple



Çap Dia (mm)	Kod Code	Fiyat (Adet) Price (Pcs)	Koli Adet Box Pcs	Kg/Koli Kg/Box
16x16	EXDRP25000001		-	-
17x16	EXDRP25000002		800	8,330
22x20	EXDRP25000003		400	6,300
25x20	EXDRP25000004		400	-

Somunlu Kurtağzı Ekleme Nipeli

Tape & GR Barbed Nipple



Çap Dia (mm)	Kod Code	Fiyat (Adet) Price (Pcs)	Koli Adet Box Pcs	Kg/Koli Kg/Box
16x16	EXDRP26000001		-	-
17x16	EXDRP26000002		800	8,450
22x20	EXDRP26000003		-	-
25x20	EXDRP26000004		-	-

Somunlu Contasız Çıkış Nipeli

Nipple Without (Without Ring)



Çap Dia (mm)	Kod Code	Fiyat (Adet) Price (Pcs)	Koli Adet Box Pcs	Kg/Koli Kg/Box
16x12	EXDRP27000001		-	-
17x12	EXDRP27000002		1000	11,320

Yüzlüklü Conta Çıkış Nipeli

Tape (With Ring) Offtake



Çap Dia (mm)	Kod Code	Fiyat (Adet) Price (Pcs)	Koli Adet Box Pcs	Kg/Koli Kg/Box
17x16	EXDRP28000001		1000	6,650
22x20	EXDRP28000002		500	6,250
25x20	EXDRP28000003		400	6,250

Yüzlüklü Ekleme Nipeli

Tape (With Ring) Nipple



Çap Dia (mm)	Kod Code	Fiyat (Adet) Price (Pcs)	Koli Adet Box Pcs	Kg/Koli Kg/Box
17x17	EXDRP29000001		1000	8,800
22x22	EXDRP29000002		500	8,330
25x25	EXDRP29000003		500	11,230

Yüzüklü Kurtağzı Ekleme Nipel Tape (With Ring) Barbed



Çap Dia (mm)	Kod Code	Fiyat (Adet) Price (Pcs)	Koli Adet Box Pcs	Kg/Koli Kg/Box
17x16	EXDRP30000001		-	-
22x20	EXDRP30000002		-	-
25x20	EXDRP30000003		-	-

Somunlu Te Dripline Tee



Çap Dia (mm)	Kod Code	Fiyat (Adet) Price (Pcs)	Koli Adet Box Pcs	Kg/Koli Kg/Box
20x20x20	EXDRP31000001		150	5,580
22x22x22	EXDRP31000002		150	7,850
25x25x25	EXDRP31000003		150	7,350

Somunlu Dış Dişli Dirsek Dripline - Male Elbow



Çap Dia (mm)	Kod Code	Fiyat (Adet) Price (Pcs)	Koli Adet Box Pcs	Kg/Koli Kg/Box
17x1/2"	EXDRP32000001		300	4,500
22x1/2"	EXDRP32000002		250	4,600
25x1/2"	EXDRP32000003		250	5,200

Somunlu Conta Çıkış Te Tape (With Ring) Grommet Tee



Çap Dia (mm)	Kod Code	Fiyat (Adet) Price (Pcs)	Koli Adet Box Pcs	Kg/Koli Kg/Box
17x16x17	EXDRP33000001		250	7,630
17x20x17	EXDRP33000002		-	-
20x20x20	EXDRP33000003		-	-
22x20x22	EXDRP33000004		200	6,900
25x20x25	EXDRP33000005		200	7,660

Yüzüklü Conta Çıkış Te Tape (With Ring) Grommet Tee



Çap Dia (mm)	Kod Code	Fiyat (Adet) Price (Pcs)	Koli Adet Box Pcs	Kg/Koli Kg/Box
17x16x17	EXDRP34000001		250	5,250
17x20x17	EXDRP34000002		250	5,820
22x20x22	EXDRP34000003		200	6,150
25x20x25	EXDRP34000004		200	-

Somunlu Dış Dişli Te Tape (With Ring) Male Tee



Çap Dia (mm)	Kod Code	Fiyat (Adet) Price (Pcs)	Koli Adet Box Pcs	Kg/Koli Kg/Box
17x1/2"x17	EXDRP35000001		250	6,150
22x1/2"x22	EXDRP35000002		200	8,650
25x1/2"x25	EXDRP35000003		200	9,560

Yüzüklü Dış Dişli Te Dripline Male Tee



Çap Dia (mm)	Kod Code	Fiyat (Adet) Price (Pcs)	Koli Adet Box Pcs	Kg/Koli Kg/Box
17x1/2"x17	EXDRP36000001		250	5,950
22x1/2"x22	EXDRP36000002		250	7,400
25x1/2"x25	EXDRP36000003		200	-

Kanallı Conta Barbed Grommet Gasket



Çap Dia (mm)	Kod Code	Fiyat (Adet) Price (Pcs)	Koli Adet Box Pcs	Kg/Koli Kg/Box
16	EXDRP37000001		3000	10,800
20	EXDRP37000002		2000	9,200
8	EXDRP37000003		-	-

Düz Conta Barbed Grommet Gasket



Çap Dia (mm)	Kod Code	Fiyat (Adet) Price (Pcs)	Koli Adet Box Pcs	Kg/Koli Kg/Box
16	EXDRP38000001		3000	12,800
20	EXDRP38000002		2000	9,460

Kanallı Conta Tapa Barbed Grommet End Cap Gasket



Çap Dia (mm)	Kod Code	Fiyat (Adet) Price (Pcs)	Koli Adet Box Pcs	Kg/Koli Kg/Box
16	EXDRP39000001		3000	10,450
20	EXDRP39000002		2000	11,350

3 mm Delici 3 mm Manuel Driller



Çap Dia (mm)	Kod Code	Fiyat (Adet) Price (Pcs)	Koli Adet Box Pcs	Kg/Koli Kg/Box
3	EXDRP40000001		50	2,250

Kangal Delme Aparatı Manuel Driller



Çap Dia (mm)	Kod Code	Fiyat (Adet) Price (Pcs)	Koli Adet Box Pcs	Kg/Koli Kg/Box
16	EXDRP41000001		50	3,070
20	EXDRP41000002		50	3,300

Kangal Delme Aparatı (Matkap) Driller



Çap Dia (mm)	Kod Code	Fiyat (Adet) Price (Pcs)	Koli Adet Box Pcs	Kg/Koli Kg/Box
16	EXDRP42000001		100	2,750
20	EXDRP42000002		100	3,500

PC Basınç Ayarlı Damlatıcı

PC Emmitter



Çap Dia (mm)	Kod Code	Fiyat (Adet) Price (Pcs)	Koli Adet Box Pcs	Kg/Koli Kg/Box
2 L/h	EXDRP43000001		2500	10,150
4 L/h	EXDRP43000002		2500	10,410
8 L/h	EXDRP43000003		2500	10,350
16 L/h	EXDRP43000004		2500	10,300

Siyah Hat Üstü Damlatıcı

Black On-Line Dripper



Çap Dia (mm)	Kod Code	Fiyat (Adet) Price (Pcs)	Koli Adet Box Pcs	Kg/Koli Kg/Box
0-150 L/h	EXDRP44000001		2000	10,350

Yeşil Hat Üstü Damlatıcı

Green On-Line Dripper



Çap Dia (mm)	Kod Code	Fiyat (Adet) Price (Pcs)	Koli Adet Box Pcs	Kg/Koli Kg/Box
0-100 L/h	EXDRP45000001		2000	8,100

Kırmızı Hat Üstü Damlatıcı

Red On-Line Dripper



Çap Dia (mm)	Kod Code	Fiyat (Adet) Price (Pcs)	Koli Adet Box Pcs	Kg/Koli Kg/Box
0-70 L/h	EXDRP46000001		5000	10,350

Spagetti Boru (Beyaz/Siyah Kaplama)

Microtube Pipe (Spaghetti)



Çap Dia (mm)	Kod Code	Fiyat (Adet) Price (Pcs)	Koli Adet Box Pcs	Kg/Koli Kg/Box
5	EXDRP47000001		250 mt	3,000
7	EXDRP47000002		250 mt	4,000
5	EXDRP47000003		60 cm	7,200
7	EXDRP47000004		60 cm	9,600
5	EXDRP47000005		100 cm	12,00
7	EXDRP47000006		100 cm	16,00

Mini Sprey 120 L/h

Radius Stable Mini Sprayer



Çap Dia (mm)	Kod Code	Fiyat (Adet) Price (Pcs)	Koli Adet Box Pcs	Kg/Koli Kg/Box
180°	EXDRP48000001		12000	19,180
360°	EXDRP48000002		15000	18,570

Basınç Ayarlı Saksı Sulama Seti

PC Emmitter Stake Set



Çap Dia (mm)	Kod Code	Fiyat (Adet) Price (Pcs)	Koli Adet Box Pcs	Kg/Koli Kg/Box
2 L/h	EXDRP49000001		500	7,150
4 L/h	EXDRP49000002		500	7,150
8 L/h	EXDRP49000003		500	7,150
16 L/h	EXDRP49000004		500	7,150

PC Damlatıcı İstavroz Konnektörü

Emmitter Four Way Manifold



Çap Dia (mm)	Kod Code	Fiyat (Adet) Price (Pcs)	Koli Adet Box Pcs	Kg/Koli Kg/Box
5 mm	EXDRP50000001		15000	12,300

PC Damlatıcı TE Konnektörü

Emmitter Tee Manifold



Çap Dia (mm)	Kod Code	Fiyat (Adet) Price (Pcs)	Koli Adet Box Pcs	Kg/Koli Kg/Box
5 mm	EXDRP51000001		24000	15,150

PC Damlatıcı Dirsek Konnektörü

Emmitter Elbow Manifold



Çap Dia (mm)	Kod Code	Fiyat (Adet) Price (Pcs)	Koli Adet Box Pcs	Kg/Koli Kg/Box
5 mm	EXDRP52000001		30000	15,750

PC Damlatıcı Çıkış Konnektörü

Emmitter Outlet Connector



Çap Dia (mm)	Kod Code	Fiyat (Adet) Price (Pcs)	Koli Adet Box Pcs	Kg/Koli Kg/Box
5 mm	EXDRP53000001		45000	14,150

Körtapa

Plug For Microtube



Çap Dia (mm)	Kod Code	Fiyat (Adet) Price (Pcs)	Koli Adet Box Pcs	Kg/Koli Kg/Box
7 mm	EXDRP54000001		45000	13,450

Hortum Eki

Coupling For Microtube



Çap Dia (mm)	Kod Code	Fiyat (Adet) Price (Pcs)	Koli Adet Box Pcs	Kg/Koli Kg/Box
5 mm	EXDRP55000001		48000	14,950
7 mm	EXDRP55000002		18000	13,550

Saksı Sulama Kazığı

Hydroponic Stake



Çap Dia (mm)	Kod Code	Fiyat (Adet) Price (Pcs)	Koli Adet Box Pcs	Kg/Koli Kg/Box
5 mm	EXDRP56000001		-	-
5 mm (2.3 L/h)	EXDRP56000002		-	-

Start Çıkışı

Starter Outlet Microtube



Çap Dia (mm)	Kod Code	Fiyat (Adet) Price (Pcs)	Koli Adet Box Pcs	Kg/Koli Kg/Box
5 mm	EXDRP57000001		-	-

PBT Yeni Nesil Vana
 PBT New Generation Valve

Çap Dia (mm)	Kod Code	Fiyat (Adet) Price (Pcs)	Koli Adet Box Pcs	Kg/Koli Kg/Box
1/2"	EXDRP58000001		250	-
3/4"	EXDRP58000002		125	12,500
1"	EXDRP58000003		65	10,750
1 1/4"	EXDRP58000004		40	9,460
1 1/2"	EXDRP58000005		35	10,760
2"	EXDRP58000006		18	10,000
2 1/2"	EXDRP58000007		12	11,150
3"	EXDRP58000008		7	10,100
4"	EXDRP58000009		4	12,550

PBT Yeni Nesil Metal Dişli Vana
 PBT New Generation Valve With Metal Female Threaded

Çap Dia (mm)	Kod Code	Fiyat (Adet) Price (Pcs)	Koli Adet Box Pcs	Kg/Koli Kg/Box
1 1/2"	EXDRP59000001		-	-
2"	EXDRP59000002		-	-
2 1/2"	EXDRP59000003		-	-
3"	EXDRP59000004		-	-
4"	EXDRP59000005		-	-

3/4" Yeni Nesil Sprey Sprink
 3/4" Garden & Land Sprey

Çap Dia (mm)	Kod Code	Fiyat (Adet) Price (Pcs)	Koli Adet Box Pcs	Kg/Koli Kg/Box
3/4"	EXDRP77000001		400	8,500

Sprink Manşonu
 Reduction

Çap Dia (mm)	Kod Code	Fiyat (Adet) Price (Pcs)	Koli Adet Box Pcs	Kg/Koli Kg/Box
32x20	EXDRP78000001		350	-
32x25	EXDRP78000002		350	-
32x32	EXDRP78000003		-	-

Plastik Mini Filtre (Krom Elek)
 Plastic Mini Filter (Sieve)

Çap Dia (mm)	Kod Code	Fiyat (Adet) Price (Pcs)	Koli Adet Box Pcs	Kg/Koli Kg/Box
20"	EXDRP60000001		20	8,920
25"	EXDRP60000002		20	7,100
32"	EXDRP60000003		20	7,050
40"	EXDRP60000004		7	6,150
50"	EXDRP60000005		7	6,160
63"	EXDRP60000006		7	6,550

Plastik Filtre (Krom Elek)
 Plastic Filter (Sieve)

Çap Dia (mm)	Kod Code	Fiyat (Adet) Price (Pcs)	Koli Adet Box Pcs	Kg/Koli Kg/Box
2 1/2"	EXDRP61000001		1	-
3"	EXDRP61000002		1	-
4"	EXDRP61000003		1	-

Plastik Filtre (Disk)
 Plastic Filter (Disc)

Çap Dia (mm)	Kod Code	Fiyat (Adet) Price (Pcs)	Koli Adet Box Pcs	Kg/Koli Kg/Box
2 1/2"	EXDRP62000001		1	8,600
3"	EXDRP62000002		1	-
4"	EXDRP62000003		1	-

Double Filtre
 Double Plastic Filter

Çap Dia (mm)	Kod Code	Fiyat (Adet) Price (Pcs)	Koli Adet Box Pcs	Kg/Koli Kg/Box
2 1/2" Krom Elek	EXDRP63000001		1	15,180
3" Krom Elek	EXDRP63000002		1	-
4" Krom Elek	EXDRP63000003		1	-
2 1/2" Disk	EXDRP63000004		1	-
3" Disk	EXDRP63000005		1	-
4" Disk	EXDRP63000006		1	-

Filtre İç Takımı
 Mini Filter Interior Set

Çap Dia (mm)	Kod Code	Fiyat (Adet) Price (Pcs)	Koli Adet Box Pcs	Kg/Koli Kg/Box
Small	EXDRP64000001		25	7,300
Big	EXDRP64000002		25	4,880

Abot Üstü Dağıtıcı
 Pipe Distributor

Çap Dia (mm)	Kod Code	Fiyat (Adet) Price (Pcs)	Koli Adet Box Pcs	Kg/Koli Kg/Box
32x32x20	EXDRP65000001	①	100	5,760
32x32x25	EXDRP65000002	①	100	5,710

Çap Dia (mm)	Kod Code	Fiyat (Adet) Price (Pcs)	Koli Adet Box Pcs	Kg/Koli Kg/Box
32x25x20	EXDRP66000001		150	5,570

Çap Dia (mm)	Kod Code	Fiyat (Adet) Price (Pcs)	Koli Adet Box Pcs	Kg/Koli Kg/Box
32x20	EXDRP67000001		150	9,350

Kazık Saplama
 Stake Fixing

Çap Dia (mm)	Kod Code	Fiyat (Adet) Price (Pcs)	Koli Adet Box Pcs	Kg/Koli Kg/Box
1/2x20	EXDRP68000001		400	7,820
1/2x25	EXDRP68000002		300	7,360

Çap Dia (mm)	Kod Code	Fiyat (Adet) Price (Pcs)	Koli Adet Box Pcs	Kg/Koli Kg/Box
1/2x1/2	EXDRP69000001		500	7,970

PP

ÜRÜN GRUBU

PRODUCT LINE

ÜRETİM STANDARDI
 PRODUCTION STANDARD | TS ISO 9911

ÇAP / SIZE Ø20 - Ø400



PP Kelebek Vana (Çıplak)
PP Butterfly Valve (Without Flange)

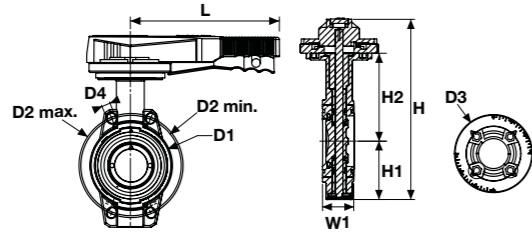

Çap Dia	DN	D1 (mm)	D2 min. (mm)	D2 max. (mm)	D3 (mm)	D4 (mm)	L (mm)	H (mm)	H1 (mm)	H2 (mm)	W1 (mm)	nØe	kv-value l/min.	ISO 5211 ISO 5211
63	50	104	120	125	115	19	207	256	82	126	45	4 x 19	1470	F 07
75	65	115	140	145	115	19	207	265	86	129	46	4 x 19	2200	F 07
90	80	131	150	160	115	19	207	272	89	132	48	8 x 19	3000	F 07
110	100	160	175	190	115	19	207	311	103	156	56	8 x 19	6500	F 07
125	110	190	210	216	115	23	258	338	116	169	63	8 x 23	11500	F 07
140	125	190	210	216	115	23	258	338	116	169	63	8 x 23	11500	F 07
160	150	214	241	241	115	24	258	364	129	182	66	8 x 24	16600	F 07
200	175	268	290	295	115	24	335	414	158	203	75	8 x 24	39600	F 07
225	200	268	290	295	115	24	335	414	158	203	75	8 x 24	39600	F 07

Çap Dia	Basınç PN	Kod Code	Fiyat (Adet) Price (Pcs)	Kg /Adet Kg/Pcs	Koli/Ad. Box/Pcs
63	10	420 00 063 2		1,18	1
75	10	420 00 075 2		1,26	1
90	10	420 00 090 2		1,42	1
110	10	420 00 110 2		2,23	1
125	10	420 00 125 2		2,77	1

Çap Dia	Basınç PN	Kod Code	Fiyat (Adet) Price (Pcs)	Kg /Adet Kg/Pcs	Koli/Ad. Box/Pcs
140	10	420 00 140 2		2,77	1
160	10	420 00 160 2		3,22	1
200	10	420 00 200 2		5,12	1
225	10	420 00 225 2		5,12	1

PP Flanşlı Kelebek Vana (Takım)
PP Butterfly Valve (With Flange)

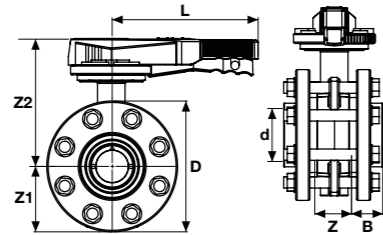

Çap Dia	Basınç PN	Kod Code	Fiyat (Adet) Price (Pcs)	Kg /Adet Kg/Pcs	Koli/Ad. Box/Pcs	DN	D (mm)	Z (mm)	Z1 (mm)	Z2 (mm)	B (mm)	L (mm)	Q1 (mm)	Q2 (mm)	nØe	ISO 5211 ISO 5211	kv-value l/min.
63	10	421 00 063 2		3,00	1	50	165	51	82	188	38	207	37		4 x 19	F 07	1470
75	10	421 00 075 2		3,60	1	65	185	52	92	180	43	207	50	40	4 x 19	F 07	2200
90	10	421 00 090 2		5,45	1	80	200	58	100	183	51	207	65	46	8 x 19	F 07	3000
110	10	421 00 110 2		6,60	1	100	220	66	110	208	60	258	85	68	8 x 19	F 07	6500
125	10	421 00 125 2		9,50	1	110	250	73	125	221	69	258	111	92	8 x 23	F 07	11500
140	10	421 00 140 2		9,90	1	125	250	73	125	221	75	258	111	92	8 x 23	F 07	11500
160	10	421 00 160 2		11,4	1	150	285	76	142	235	86	258	138	122	8 x 24	F 07	16600
200	10	421 00 200 2		17,1	1	175	340	87	170	255	106	335	192	179	8 x 24	F 07	39600
225	10	421 00 225 2		17,1	1	200	340	87	170	255	120	335	192	179	8 x 24	F 07	39600

PP Flanşlı Kelebek Vana (Takım-304 Paslanmaz Civata-Somun Pul)
PP Butterfly Valve With Flange (304 S.S. Screw, Nut, Washer)

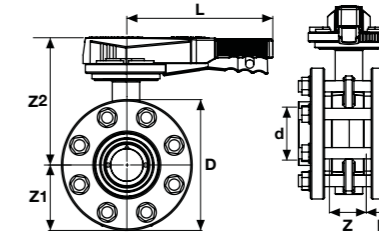

Çap Dia	Basınç PN	Kod Code	Fiyat (Adet) Price (Pcs)	Kg /Adet Kg/Pcs	Koli/Ad. Box/Pcs	DN	D (mm)	Z (mm)	Z1 (mm)	Z2 (mm)	B (mm)	L (mm)	nØe	ISO 5211 ISO 5211	kv-value l/min.
63	10	422 00 063 2		3,00	1	50	165	51	82	188	38	207	4 x 19	F 07	1470
75	10	422 00 075 2		3,60	1	65	185	52	92	180	43	207	4 x 19	F 07	2200
90	10	422 00 090 2		5,45	1	80	200	58	100	183	51	207	8 x 19	F 07	3000
110	10	422 00 110 2		6,60	1	100	220	66	110	208	60	258	8 x 19	F 07	6500
125	10	422 00 125 2		9,50	1	110	250	73	125	221	69	258	8 x 23	F 07	11500
140	10	422 00 140 2		9,90	1	125	250	73	125	221	75	258	8 x 23	F 07	11500
160	10	422 00 160 2		11,4	1	150	285	76	142	235	86	258	8 x 24	F 07	16600
200	10	422 00 200 2		17,1	1	175	340	87	170	255	106	335	8 x 24	F 07	39600
225	10	422 00 225 2		17,1	1	200	340	87	170	255	120	335	8 x 24	F 07	39600

PP Flanşlı Kelebek Vana (Takım-316 Paslanmaz Civata-Somun Pul)
PP Butterfly Valve With Flange (316 S.S. Screw, Nut, Washer)

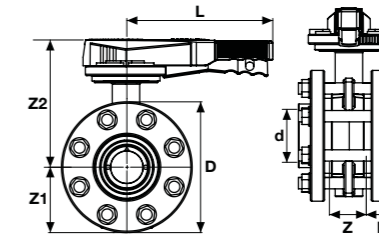

Çap Dia	Basınç PN	Kod Code	Fiyat (Adet) Price (Pcs)	Kg /Adet Kg/Pcs	Koli/Ad. Box/Pcs	DN	D (mm)	Z (mm)	Z1 (mm)	Z2 (mm)	B (mm)	L (mm)	nØe	ISO 5211 ISO 5211	kv-value l/min.
63	10	423 00 063 2		3,00	1	50	165	51	82	188	38	207	4 x 19	F 07	1470
75	10	423 00 075 2		3,60	1	65	185	52	92	180	43	207	4 x 19	F 07	2200
90	10	423 00 090 2		5,45	1	80	200	58	100	183	51	207	8 x 19	F 07	3000
110	10	423 00 110 2		6,60	1	100	220	66	110	208	60	258	8 x 19	F 07	6500
125	10	423 00 125 2		9,50	1	110	250	73	125	221	69	258	8 x 23	F 07	11500
140	10	423 00 140 2		9,90	1	125	250	73	125	221	75	258	8 x 23	F 07	11500
160	10	423 00 160 2		11,4	1	150	285	76	142	235	86	258	8 x 24	F 07	16600
200	10	423 00 200 2		17,1	1	175	340	87	170	255	106	335	8 x 24	F 07	39600
225	10	423 00 225 2		17,1	1	200	340	87	170	255	120	335	8 x 24	F 07	39600

PP Redüktör Dişli Kelebek Vana (Çıplak)

PP Reduction Gear Butterfly Valve With Handwhell (Without Flange)

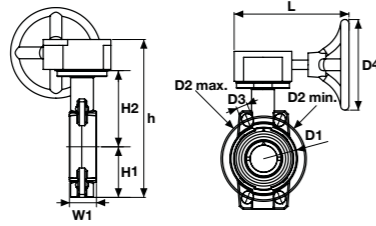

Çap Dia	DN	D1 (mm)	D2 min. (mm)	D2 max. (mm)	D3 (mm)	D4 (mm)	L (mm)	H (mm)	H1 (mm)	H2 (mm)	W1 (mm)	nØe	kv-value l/min.	ISO 5211 ISO 5211
63	50	104	120	125	115	19	192	279	82	126	45	4 x 19	1470	F 07
75	65	115	140	145	115	19	192	288	86	129	46	4 x 19	2200	F 07
90	80	131	150	160	115	19	192	290	89	132	48	8 x 19	3000	F 07
110	100	160	175	190	115	19	192	337	103	156	56	8 x 19	6500	F 07
125	110	190	210	216	115	23	192	353	116	169	63	8 x 23	11500	F 07
140	125	190	210	216	115	23	192	353	116	169	63	8 x 23	11500	F 07
160	150	214	241	241	115	24	192	375	129	182	66	8 x 24	16600	F 07
200	175	268	290	295	115	24	192	429	158	203	75	8 x 24	39600	F 07
225	200	268	290	295	115	24	192	429	158	203	75	8 x 24	39600	F 07

Çap Dia	Basınç PN	Kod Code	Fiyat (Adet) Price (Pcs)	Kg /Adet Kg/Pcs	Koli/Ad. Box/Pcs
63	10	424 00 063 2		1,12	1
75	10	424 00 075 2		4,65	1
90	10	424 00 090 2		1,12	1
110	10	424 00 110 2		5,57	1
125	10	424 00 125 2		7,53	1

Çap Dia	Basınç PN	Kod Code	Fiyat (Adet) Price (Pcs)	Kg /Adet Kg/Pcs	Koli/Ad. Box/Pcs
140	10	424 00 140 2			1
160	10	424 00 160 2		8,14	1
200	10	424 00 200 2		10,9	1
225	10	424 00 225 2		10,9	1

PP Redüktör Dişli Flanşlı Kelebek Vana (Takım)

PP Reduction Gear Butterfly Valve With Handwhell and Flange

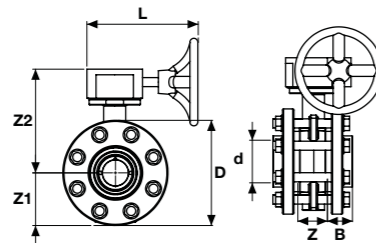

Çap Dia	Basınç PN	Kod Code	Fiyat (Adet) Price (Pcs)	Kg /Adet Kg/Pcs	Koli/Ad. Box/Pcs	DN	D (mm)	Z (mm)	Z1 (mm)	Z2 (mm)	B (mm)	L (mm)	nØe	kv-value l/min.	ISO 5211 ISO 5211
63	10	425 00 063 2		3,00	1	50	165	51	82	196	38	192	4 x 19	1470	F 07
75	10	425 00 075 2		3,60	1	65	185	52	92	191	43	192	4 x 19	2200	F 07
90	10	425 00 090 2		5,45	1	80	200	58	100	190	51	192	8 x 19	3000	F 07
110	10	425 00 110 2		6,60	1	100	220	66	110	227	60	192	8 x 19	6500	F 07
125	10	425 00 125 2		9,50	1	110	250	73	125	228	69	192	8 x 23	11500	F 07
140	10	425 00 140 2		9,90	1	125	250	73	125	228	75	192	8 x 23	11500	F 07
160	10	425 00 160 2		11,4	1	150	285	76	142	232	86	192	8 x 24	16600	F 07
200	10	425 00 200 2		17,1	1	175	340	87	170	259	106	192	8 x 24	39600	F 07
225	10	425 00 225 2		17,1	1	200	340	87	170	259	120	192	8 x 24	39600	F 07

PP Redüktör Dişli Flanşlı Kelebek Vana (Takım-304 Paslanmaz Civata-Somun-Pul)

PP Reduction Gear Butterfly Valve With Handwhell and Flange (304 S.S. Screw,Nut,Washer)

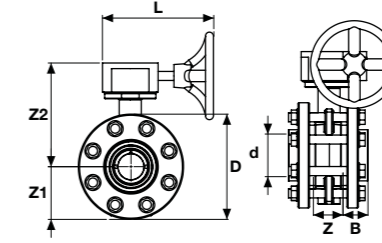

Çap Dia	Basınç PN	Kod Code	Fiyat (Adet) Price (Pcs)	Kg /Adet Kg/Pcs	Koli/Ad. Box/Pcs	DN	D (mm)	Z (mm)	Z1 (mm)	Z2 (mm)	B (mm)	L (mm)	nØe	Inch	kv-value l/min.	ISO 5211 ISO 5211
63	10	426 00 063 2			1	50	165	51	82	196	38	192	4 x 19	2"	1470	F 07
75	10	426 00 075 2			1	65	185	52	92	191	43	192	4 x 19	2 1/2"	2200	F 07
90	10	426 00 090 2			1	80	200	58	100	190	51	192	8 x 19	3"	3000	F 07
110	10	426 00 110 2			1	100	220	66	110	227	60	192	8 x 19	4"	6500	F 07
125	10	426 00 125 2			1	110	250	73	125	228	69	192	8 x 23	4 1/2"	11500	F 07
140	10	426 00 140 2		12,5	1	125	250	73	125	228	75	192	8 x 23	5"	11500	F 07
160	10	426 00 160 2			1	150	285	76	142	232	86	192	8 x 24	6"	16600	F 07
200	10	426 00 200 2		17,1	1	175	340	87	170	259	106	192	8 x 24	7"	39600	F 07
225	10	426 00 225 2			1	200	340	87	170	259	120	192	8 x 24	8"	39600	F 07

PP Redüktör Dişli Flanşlı Kelebek Vana (Takım-316 Paslanmaz Civata-Somun-Pul)

PP Reduction Gear Butterfly Valve With Handwhell and Flange (316 S.S. Screw,Nut,Washer)

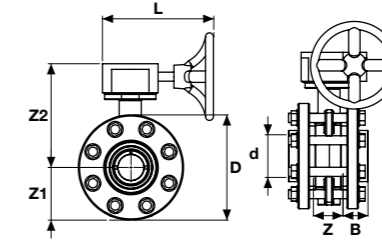

Çap Dia	Basınç PN	Kod Code	Fiyat (Adet) Price (Pcs)	Kg /Adet Kg/Pcs	Koli/Ad. Box/Pcs	DN	D (mm)	Z (mm)	Z1 (mm)	Z2 (mm)	B (mm)	L (mm)	nØe	ISO 5211 ISO 5211	Inch	kv-value l/min.
63	10	427 00 063 2			1	50	165	51	82	196	38	192	4 x 19	F 07	2"	1470
75	10	427 00 075 2			1	65	185	52	92	191	43	192	4 x 19	F 07	2 1/2"	2200
90	10	427 00 090 2			1	80	200	58	100	190	51	192	8 x 19	F 07	3"	3000
110	10	427 00 110 2			1	100	220	66	110	227	60	192	8 x 19	F 07	4"	6500
125	10	427 00 125 2			1	110	250	73	125	228	69	192	8 x 23	F 07	4 1/2"	11500
140	10	427 00 140 2			1	125	250	73	125	228	75	192	8 x 23	F 07	5"	11500
160	10	427 00 160 2			1	150	285	76	142	232	86	192	8 x 24	F 07	6"	16600
200	10	427 00 200 2			1	175	340	87	170	259	106	192	8 x 24	F 07	7"	39600
225	10	427 00 225 2			1	200	340	87	170	259	120	192	8 x 24	F 07	8"	39600

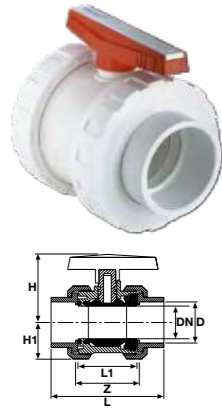
PP Küresel Vana
 PP True Union Ball Valve

Çap Dia	Basınç PN	Kg/Adet Kg/Pcs	Koli/Adet Box/Pcs	DN (mm)	kv l/min	Z (mm)	L1 (mm)	L (mm)	H (mm)	H1 (mm)
20	10	0,14	55	15	185	52	45	85	47	27
25	10	0,18	75	20	350	58	49	95	51	31
32	10	0,25	60	25	700	61	54	107	63	33
40	10	0,43	30	32	1000	73	66	128	67	41
50	10	0,65	20	40	1600	82	75	154	86	46
63	10	1,13	12	50	3100	95	89	172	101	58
75	10	1,47	9	65	5000	118	111	196	110	73
90	10	3,58	4	80	7000	139	126	241	137	89
110	10	5,43	2	100	11000	165	153	289	150	105

● beyaz / white

● bej / beige

● yeşil / green

● mavi / blue

Çap Dia	EPDM Conta Kod EPDM O-Ring Code	Fiyat (Adet) Price (Pcs)	EPDM Conta Kod EPDM O-Ring Code	Fiyat (Adet) Price (Pcs)	EPDM Conta Kod EPDM O-Ring Code	Fiyat (Adet) Price (Pcs)	EPDM Conta Kod EPDM O-Ring Code	Fiyat (Adet) Price (Pcs)
20	400 00 020 2		400 20 020 2		400 40 020 2		400 60 020 2	
25	400 00 025 2		400 20 025 2		400 40 025 2		400 60 025 2	
32	400 00 032 2		400 20 032 2		400 40 032 2		400 60 032 2	
40	400 00 040 2		400 20 040 2		400 40 040 2		400 60 040 2	
50	400 00 050 2		400 20 050 2		400 40 050 2		400 60 050 2	
63	400 00 063 2		400 20 063 2		400 40 063 2		400 60 063 2	
75	400 00 075 2		400 20 075 2		400 40 075 2		400 60 075 2	
90	400 00 090 2		400 20 090 2		400 40 090 2		400 60 090 2	
110	400 00 110 2		400 20 110 2		400 40 110 2		400 60 110 2	

PP Çift Taraf İçten Dişli Küresel Vana
 PP Both Sides Female Threaded Ball Valve

Çap Dia	Rp (Inch)	Basınç PN	Kg/Adet Kg/Pcs	Koli/Adet Box/Pcs	DN (mm)	kv l/min	Z (mm)	L1 (mm)	L (mm)	H (mm)	H1 (mm)
20	1/2"	10	0,14	55	15	185	52	45	85	47	27
25	3/4"	10	0,19	75	20	350	58	49	95	51	31
32	1"	10	0,24	60	25	700	61	54	107	63	33
40	1 1/4"	10	0,42	30	32	1000	73	66	128	67	41
50	1 1/2"	10	0,66	20	40	1600	82	75	154	86	46
63	2"	10	1,17	12	50	3100	95	89	172	101	58
75	2 1/2"	10	1,48	9	65	5000	118	111	196	110	73
90	3"	10	3,56	4	80	7000	139	126	241	137	89
110	4"	10	5,35	2	100	11000	165	153	289	150	105

● beyaz / white

● bej / beige

● yeşil / green

● mavi / blue

Rp (Inch)	EPDM Conta Kod EPDM O-Ring Code	Fiyat (Adet) Price (Pcs)	EPDM Conta Kod EPDM O-Ring Code	Fiyat (Adet) Price (Pcs)	EPDM Conta Kod EPDM O-Ring Code	Fiyat (Adet) Price (Pcs)	EPDM Conta Kod EPDM O-Ring Code	Fiyat (Adet) Price (Pcs)
1/2"	402 00 020 2		402 20 020 2		402 40 020 2		402 60 020 2	
3/4"	402 00 025 2		402 20 025 2		402 40 025 2		402 60 025 2	
1"	402 00 032 2		402 20 032 2		402 40 032 2		402 60 032 2	
1 1/4"	402 00 040 2		402 20 040 2		402 40 040 2		402 60 040 2	
1 1/2"	402 00 050 2		402 20 050 2		402 40 050 2		402 60 050 2	
2"	402 00 063 2		402 20 063 2		402 40 063 2		402 60 063 2	
2 1/2"	402 00 075 2		402 20 075 2		402 40 075 2		402 60 075 2	
3"	402 00 090 2		402 20 090 2		402 40 090 2		402 60 090 2	
4"	402 00 110 2		402 20 110 2		402 40 110 2		402 60 110 2	

PP Tek Taraf İçten Dişli Küresel Vana
 PP One Side Female Threaded Ball Valve

Çap Dia	Rp (Inch)	Basınç PN	Kg/Adet Kg/Pcs	Koli/Adet Box/Pcs	DN (mm)	kv l/min	Z (mm)	L1 (mm)	L (mm)	H (mm)	H1 (mm)
20	1/2"	10	0,14	55	15	185	52	45	85	47	27
25	3/4"	10	0,19	75	20	350	58	49	95	51	31
32	1"	10	0,24	60	25	700	61	54	107	63	33
40	1 1/4"	10	0,42	30	32	1000	73	66	128	67	41
50	1 1/2"	10	0,66	20	40	1600	82	75	154	86	46
63	2"	10	1,17	12	50	3100	95	89	172	101	58
75	2 1/2"	10	1,48	9	65	5000	118	111	196	110	73
90	3"	10	3,56	4	80	7000	139	126	241	137	89
110	4"	10	5,35	2	100	11000	165	153	289	150	105

● beyaz / white

● bej / beige

● yeşil / green

● mavi / blue

Çap Dia	Rp (Inch)	EPDM Conta Kod EPDM O-Ring Code	Fiyat (Adet) Price (Pcs)	EPDM Conta Kod EPDM O-Ring Code	Fiyat (Adet) Price (Pcs)	EPDM Conta Kod EPDM O-Ring Code	Fiyat (Adet) Price (Pcs)	EPDM Conta Kod EPDM O-Ring Code	Fiyat (Adet) Price (Pcs)
20	1/2"	401 00 020 2		401 20 020 2		401 40 020 2		401 60 020 2	
25	3/4"	401 00 025 2		401 20 025 2		401 40 025 2		401 60 025 2	
32	1"	401 00 032 2		401 20 032 2		401 40 032 2		401 60 032 2	
40	1 1/4"	401 00 040 2		401 20 040 2		401 40 040 2		401 60 040 2	
50	1 1/2"	401 00 050 2		401 20 050 2		401 40 050 2		401 60 050 2	
63	2"	401 00 063 2		401 20 063 2		401 40 063 2		401 60 063 2	
75	2 1/2"	401 00 075 2		401 20 075 2		401 40 075 2		401 60 075 2	
90	3"	401 00 090 2		401 20 090 2		401 40 090 2		401 60 090 2	
110	4"	401 00 110 2		401 20 110 2		401 40 110 2		401 60 110 2	

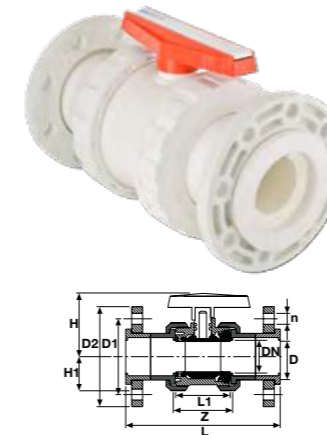
PP Çift Taraf Flanş Bağlantılı Küresel Vana
 PP Both Sides Flanged Ball Valve

Çap Dia	Basınç PN	Kg/Adet Kg/Pcs	Koli/Adet Box/Pcs	DN (mm)	kv l/min	Z (mm)	L1 (mm)	L (mm)	H (mm)	H1 (mm)	D1 (mm)	D2 (mm)	n (mmxAdet)
20	10	0,36	40	15	185	52	45	123	47	27	65	95	14 x 4
25	10	0,47	30	20	350	58	49	140	51	31	75	105	14 x 4
32	10	0,66	25	25	700	61	54	158	63	33	85	115	14 x 4
40	10	1,08	20	32	1000	73	66	186	67	42	100	140	18 x 4
50	10	1,44	10	40	1600	82	75	231	86	46	110	150	18 x 4
63	10	2,29	10	50	3100	95	89	253	101	58	125	165	18 x 4
75	10	2,99	4	65	5000	118	111	291	110	73	145	185	18 x 4
90	10	5,7	2	80	7000	139	126	353	137	90	160	200	18 x 8
110	10	8,05	1	100	11000	165	153	431	150	106	180	220	18 x 8

● beyaz / white

● bej / beige

● yeşil / green

● mavi / blue

Çap Dia	EPDM Conta Kod EPDM O-Ring Code	Fiyat (Adet) Price (Pcs)	EPDM Conta Kod EPDM O-Ring Code	Fiyat (Adet) Price (Pcs)	EPDM Conta Kod EPDM O-Ring Code	Fiyat (Adet) Price (Pcs)	EPDM Conta Kod EPDM O-Ring Code	Fiyat (Adet) Price (Pcs)
20	403 00 020 2		403 20 020 2		403 40 020 2		403 60 020 2	
25	403 00 025 2		403 20 025 2		403 40 025 2		403 60 025 2	
32	403 00 032 2		403 20 032 2		403 40 032 2		403 60 032 2	
40	403 00 040 2		403 20 040 2		403 40 040 2		403 60 040 2	
50	403 00 050 2		403 20 050 2		403 40 050 2		403 60 050 2	
63	403 00 063 2		403 20 063 2		403 40 063 2		403 60 063 2	
75	403 00 075 2		403 20 075 2		403 40 075 2		403 60 075 2	
90	403 00 090 2		403 20 090 2		403 40 090 2		403 60 090 2	
110	403 00 110 2		403 20 110 2		403 40 110 2		403 60 110 2	

PP Küresel Vana Tek Taraf Piriç İçten Dişli
 PP Ball Valve One Side Brass Female Threaded

Çap Dia	Rp (Inch)	Basınç PN	Kg/Adet Kg/Pcs	Koli/Adet Box/Pcs	DN (mm)	kv l/min	Z (mm)	L1 (mm)	L (mm)	H (mm)	H1 (mm)
20	1/2"	10	0,18	55	15	185	52	45	86	47	27
25	3/4"	10	0,24	75	20	350	58	49	96	51	31
32	1"	10	0,31	60	25	700	61	54	106	63	33
40	1 1/4"	10	0,50	30	32	1000	73	66	127	67	42
50	1 1/2"	10	0,80	20	40	1600	82	75	153	86	46
63	2"	10	1,36	12	50	3100	95	89	172	101	58

beyaz / white

bej / beige

yeşil / green

mavi / blue

Çap Dia	Rp (Inch)	EPDM Conta Kod EPDM O-Ring Code	Fiyat (Adet) Price (Pcs)	EPDM Conta Kod EPDM O-Ring Code	Fiyat (Adet) Price (Pcs)	EPDM Conta Kod EPDM O-Ring Code	Fiyat (Adet) Price (Pcs)	EPDM Conta Kod EPDM O-Ring Code	Fiyat (Adet) Price (Pcs)
20	1/2"	411 00 020 2		411 05 020 2		411 10 020 2		411 15 020 2	
25	3/4"	411 00 025 2		411 05 025 2		411 10 025 2		411 15 025 2	
32	1"	411 00 032 2		411 05 032 2		411 10 032 2		411 15 032 2	
40	1 1/4"	411 00 040 2		411 05 040 2		411 10 040 2		411 15 040 2	
50	1 1/2"	411 00 050 2		411 05 050 2		411 10 050 2		411 15 050 2	
63	2"	411 00 063 2		411 05 063 2		411 10 063 2		411 15 063 2	

PP Küresel Vana Tek Taraf Piriç İçten Dişli İç Dişli
 PP Ball Valve One Side Brass Female Threaded

Çap Dia	Rp (Inch)	Basınç PN	Kg/Adet Kg/Pcs	Koli/Adet Box/Pcs	DN (mm)	kv l/min	Z (mm)	L1 (mm)	L (mm)	H (mm)	H1 (mm)
20	1/2"	10	0,20	55	15	185	52	45	86	47	27
25	3/4"	10	0,35	75	20	350	58	49	96	51	31
32	1"	10	0,31	60	25	700	61	54	106	63	33
40	1 1/4"	10		30	32	1000	73	66	127	67	42
50	1 1/2"	10		20	40	1600	82	75	153	86	46
63	2"	10	1,53	12	50	3100	95	89	172	101	58

beyaz / white

bej / beige

yeşil / green

mavi / blue

Çap Dia	Rp (Inch)	EPDM Conta Kod EPDM O-Ring Code	Fiyat (Adet) Price (Pcs)	EPDM Conta Kod EPDM O-Ring Code	Fiyat (Adet) Price (Pcs)	EPDM Conta Kod EPDM O-Ring Code	Fiyat (Adet) Price (Pcs)	EPDM Conta Kod EPDM O-Ring Code	Fiyat (Adet) Price (Pcs)
20	1/2"	414 20 020 2		414 25 020 2		414 30 020 2		414 35 020 2	
25	3/4"	414 20 025 2		414 25 025 2		414 30 025 2		414 35 025 2	
32	1"	414 20 032 2		414 25 032 2		414 30 032 2		414 35 032 2	
40	1 1/4"	414 20 040 2		414 25 040 2		414 30 040 2		414 35 040 2	
50	1 1/2"	414 20 050 2		414 25 050 2		414 30 050 2		414 35 050 2	
63	2"	414 20 063 2		414 25 063 2		414 30 063 2		414 35 063 2	

PP Küresel Vana Tek Taraf Piriç Dıştan Dişli
 PP Ball Valve One Side Brass Male Threaded

Çap Dia	Rp (Inch)	Basınç PN	Kg/Adet Kg/Pcs	Koli/Adet Box/Pcs	DN (mm)	kv l/min	Z (mm)	L1 (mm)	L (mm)	H (mm)	H1 (mm)
20	1/2"	10	0,19	55	15	185	52	45	112	47	27
25	3/4"	10	0,26	75	20	350	58	49	113	51	31
32	1"	10	0,34	60	25	700	61	54	136	63	33
40	1 1/4"	10	0,57	30	32	1000	73	66	158	67	42
50	1 1/2"	10	0,87	20	40	1600	82	75	173	86	46
63	2"	10	1,48	12	50	3100	95	89	203	101	58

beyaz / white

bej / beige

yeşil / green

mavi / blue

Çap Dia	Rp (Inch)	EPDM Conta Kod EPDM O-Ring Code	Fiyat (Adet) Price (Pcs)	EPDM Conta Kod EPDM O-Ring Code	Fiyat (Adet) Price (Pcs)	EPDM Conta Kod EPDM O-Ring Code	Fiyat (Adet) Price (Pcs)	EPDM Conta Kod EPDM O-Ring Code	Fiyat (Adet) Price (Pcs)
20	1/2"	412 00 020 2		412 05 020 2		412 10 020 2		412 15 020 2	
25	3/4"	412 00 025 2		412 05 025 2		412 10 025 2		412 15 025 2	
32	1"	412 00 032 2		412 05 032 2		412 10 032 2		412 15 032 2	
40	1 1/4"	412 00 040 2		412 05 040 2		412 10 040 2		412 15 040 2	
50	1 1/2"	412 00 050 2		412 05 050 2		412 10 050 2		412 15 050 2	
63	2"	412 00 063 2		412 05 063 2		412 10 063 2		412 15 063 2	

PP Küresel Vana Tek Taraf Piriç Dıştan Dişli İç Dişli
 PP Ball Valve One Side Brass Male Threaded Female Threaded

Çap Dia	Rp (Inch)	Basınç PN	Kg/Adet Kg/Pcs	Koli/Adet Box/Pcs	DN (mm)	kv l/min	Z (mm)	L1 (mm)	L (mm)	H (mm)	H1 (mm)
20	1/2"	10	0,21	55	15	185	52	45	112	47	27
25	3/4"	10	0,36	75	20	350	58	49	113	51	31
32	1"	10	0,33	60	25	700	61	54	136	63	33
40	1 1/4"	10	0,66	30	32	1000	73	66	158	67	42
50	1 1/2"	10	0,96	20	40	1600	82	75	173	86	46
63	2"	10	1,62	12	50	3100	95	89	203	101	58

beyaz / white

bej / beige

yeşil / green

mavi / blue

Çap Dia	Rp (Inch)	EPDM Conta Kod EPDM O-Ring Code	Fiyat (Adet) Price (Pcs)	EPDM Conta Kod EPDM O-Ring Code	Fiyat (Adet) Price (Pcs)	EPDM Conta Kod EPDM O-Ring Code	Fiyat (Adet) Price (Pcs)	EPDM Conta Kod EPDM O-Ring Code	Fiyat (Adet) Price (Pcs)
20	1/2"	414 00 020 2		414 05 020 2		414 10 020 2		414 15 020 2	
25	3/4"	414 00 025 2		414 05 025 2		414 10 025 2		414 15 025 2	
32	1"	414 00 032 2		414 05 032 2		414 10 032 2		414 15 032 2	
40	1 1/4"	414 00 040 2		414 05 040 2		414 10 040 2		414 15 040 2	
50	1 1/2"	414 00 050 2		414 05 050 2		414 10 050 2		414 15 050 2	
63	2"	414 00 063 2		414 05 063 2		414 10 063 2		414 15 063 2	

PP Rakor
PP Union

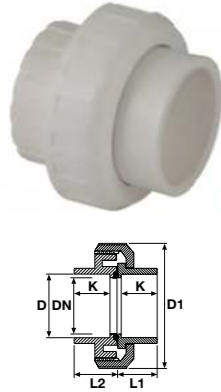

Çap Dia	Basınç PN	Kg /Adet Kg/Pcs	Koli/Ad. Box/Pcs	DN (mm)	D1 (mm)	L1 (mm)	L2 (mm)	K (mm)
20	10	0,05	125	15	54	19	24	16
25	10	0,07	100	20	62	22	27	19
32	10	0,09	50	25	65	25	30	22
40	10	0,16	30	32	83	28	36	26
50	10	0,189	45	40	93	38	42	31
63	10	0,35	30	50	116	41	52	38
75	10	0,585	18	65	129	47	54	44
90	10	0,98	9	80	155	56	61	51
110	10	1,47	7	100	178	66	71	61

● beyaz / white

● bej / beige

● yeşil / green

● mavi / blue

Çap Dia	EPDM Conta Kod EPDM O-Ring Code	Fiyat (Adet) Price (Pcs)	EPDM Conta Kod EPDM O-Ring Code	Fiyat (Adet) Price (Pcs)	EPDM Conta Kod EPDM O-Ring Code	Fiyat (Adet) Price (Pcs)	EPDM Conta Kod EPDM O-Ring Code	Fiyat (Adet) Price (Pcs)
20	406 00 020 2		406 20 020 2		406 40 020 2		406 60 020 2	
25	406 00 025 2		406 20 025 2		406 40 025 2		406 60 025 2	
32	406 00 032 2		406 20 032 2		406 40 032 2		406 60 032 2	
40	406 00 040 2		406 20 040 2		406 40 040 2		406 60 040 2	
50	406 00 050 2		406 20 050 2		406 40 050 2		406 60 050 2	
63	406 00 063 2		406 20 063 2		406 40 063 2		406 60 063 2	
75	406 00 075 2		406 20 075 2		406 40 075 2		406 60 075 2	
90	406 00 090 2		406 20 090 2		406 40 090 2		406 60 090 2	
110	406 00 110 2		406 20 110 2		406 40 110 2		406 60 110 2	

PP Çift Taraf İçten Dişli Rakor
PP Both Sides Female Threaded Union

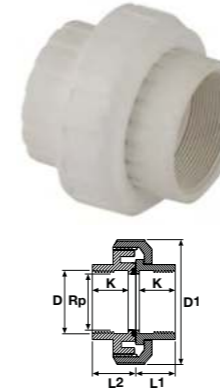

Rp (Inch)	Basınç PN	Kg /Adet Kg/Pcs	Koli/Ad. Box/Pcs	DN (mm)	D1 (mm)	L1 (mm)	L2 (mm)	K (mm)
1/2"	10	0,05	125	15	54	19	24	16
3/4"	10	0,07	100	20	62	22	27	19
1"	10	0,09	50	25	65	25	30	22
1 1/4"	10	0,15	30	32	83	28	36	26
1 1/2"	10	0,25	45	40	93	38	42	31
2"	10	0,5	30	50	116	41	52	38
2 1/2"	10	0,61	18	65	129	47	54	44
3"	10	1,04	10	80	155	56	61	51
4"	10	1,415	7	100	178	66	71	61

● beyaz / white

● bej / beige

● yeşil / green

● mavi / blue

Rp (Inch)	EPDM Conta Kod EPDM O-Ring Code	Fiyat (Adet) Price (Pcs)	EPDM Conta Kod EPDM O-Ring Code	Fiyat (Adet) Price (Pcs)	EPDM Conta Kod EPDM O-Ring Code	Fiyat (Adet) Price (Pcs)	EPDM Conta Kod EPDM O-Ring Code	Fiyat (Adet) Price (Pcs)
1/2"	408 00 020 2		408 20 020 2		408 40 020 2		408 60 020 2	
3/4"	408 00 025 2		408 20 025 2		408 40 025 2		408 60 025 2	
1"	408 00 032 2		408 20 032 2		408 40 032 2		408 60 032 2	
1 1/4"	408 00 040 2		408 20 040 2		408 40 040 2		408 60 040 2	
1 1/2"	408 00 050 2		408 20 050 2		408 40 050 2		408 60 050 2	
2"	408 00 063 2		408 20 063 2		408 40 063 2		408 60 063 2	
2 1/2"	408 00 075 2		408 20 075 2		408 40 075 2		408 60 075 2	
3"	408 00 090 2		408 20 090 2		408 40 090 2		408 60 090 2	
4"	408 00 110 2		408 20 110 2		408 40 110 2		408 60 110 2	

PP Tek Taraf İçten Dişli Rakor
PP One Side Female Threaded Union

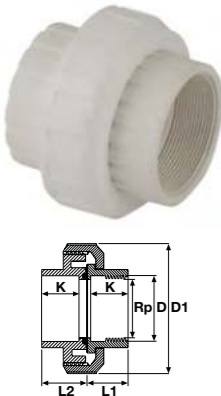

Çap Dia	Rp (Inch)	Basınç PN	Kg /Adet Kg/Pcs	Koli/Ad. Box/Pcs	DN (mm)	D1 (mm)	L1 (mm)	L2 (mm)	K (mm)
20	1/2"	10	0,05	125	15	54	19	24	16
25	3/4"	10	0,07	100	20	62	22	27	19
32	1"	10	0,085	50	25	65	25	30	22
40	1 1/4"	10	0,155	30	32	83	28	36	26
50	1 1/2"	10	0,25	45	40	93	38	42	31
63	2"	10	0,48	30	50	116	41	52	38
75	2 1/2"	10	0,6	18	65	129	47	54	44
90	3"	10	1,005	9	80	155	56	61	51
110	4"	10	1,485	7	100	178	66	71	61

● beyaz / white

● bej / beige

● yeşil / green

● mavi / blue

Çap Dia	Rp (Inch)	EPDM Conta Kod EPDM O-Ring Code	Fiyat (Adet) Price (Pcs)	EPDM Conta Kod EPDM O-Ring Code	Fiyat (Adet) Price (Pcs)	EPDM Conta Kod EPDM O-Ring Code	Fiyat (Adet) Price (Pcs)	EPDM Conta Kod EPDM O-Ring Code	Fiyat (Adet) Price (Pcs)
20	1/2"	407 00 020 2		407 20 020 2		407 40 020 2		407 60 020 2	
25	3/4"	407 00 025 2		407 20 025 2		407 40 025 2		407 60 025 2	
32	1"	407 00 032 2		407 20 032 2		407 40 032 2		407 60 032 2	
40	1 1/4"	407 00 040 2		407 20 040 2		407 40 040 2		407 60 040 2	
50	1 1/2"	407 00 050 2		407 20 050 2		407 40 050 2		407 60 050 2	
63	2"	407 00 063 2		407 20 063 2		407 40 063 2		407 60 063 2	
75	2 1/2"	407 00 075 2		407 20 075 2		407 40 075 2		407 60 075 2	
90	3"	407 00 090 2		407 20 090 2		407 40 090 2		407 60 090 2	
110	4"	407 00 110 2		407 20 110 2		407 40 110 2		407 60 110 2	

● ● ● ● Beyaz ürün harici diğer renklerde minimum adet için lütfen sorunuz. Please inquire minimum quantity for other colors except white color.

● ● ● ● Beyaz ürün harici diğer renklerde minimum adet için lütfen sorunuz. Please inquire minimum quantity for other colors except white color.

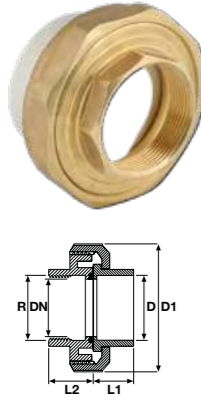
PP Rakor İç Diş Pirinç Çıkışlı
 PP Union Female Threaded Brass Outlet

Çap Dia	R Inch	Basınç PN	Kg /Adet Kg/Pcs	Koli/Adet Box/Pcs	DN (mm)	D1 (mm)	L1 (mm)	L2 (mm)
20	1/2"	10	0,075	125	15	36	19	14
25	3/4"	10	0,108	100	20	45	22	15
32	1"	10	0,155	50	25	51	25	17
40	1 1/4"	10	0,28	30	32	64	28	24
50	1 1/2"	10	0,41	45	40	80	38	22
63	2"	10	0,77	25	50	98	41	23

beyaz / white

bej / beige

yeşil / green

mavi / blue

Çap Dia	Rp (Inch)	EPDM Conta Kod EPDM O-Ring Code	Fiyat (Adet) Price (Pcs)	EPDM Conta Kod EPDM O-Ring Code	Fiyat (Adet) Price (Pcs)	EPDM Conta Kod EPDM O-Ring Code	Fiyat (Adet) Price (Pcs)	EPDM Conta Kod EPDM O-Ring Code	Fiyat (Adet) Price (Pcs)
20	1/2"	410 00 020 2		410 40 020 2		410 60 020 2		418 60 020 2	
25	3/4"	410 00 025 2		410 40 025 2		410 60 025 2		418 60 025 2	
32	1"	410 00 032 2		410 40 032 2		410 60 032 2		418 60 032 2	
40	1 1/4"	410 00 040 2		410 40 040 2		410 60 040 2		418 60 040 2	
50	1 1/2"	410 00 050 2		410 40 050 2		410 60 050 2		418 60 050 2	
63	2"	410 00 063 2		410 40 063 2		410 60 063 2		418 60 063 2	

PP Rakor İç Diş Pirinç Çıkışlı
 PP Union Female Threaded Brass Outlet

Çap Dia	R Inch	Basınç PN	Kg /Adet Kg/Pcs	Koli/Adet Box/Pcs	DN (mm)	D1 (mm)	L1 (mm)	L2 (mm)
20	1/2"	10	0,09	125	15	36	19	14
25	3/4"	10	0	100	20	45	21	15
32	1"	10	0,15	50	25	51	25	17
40	1 1/4"	10	1	50	32	64	29	24
50	1 1/2"	10	0,395	30	40	80	34	22
63	2"	10	0,66	10	50	98	41	23

beyaz / white

bej / beige

yeşil / green

mavi / blue

Çap Dia	Rp (Inch)	EPDM Conta Kod EPDM O-Ring Code	Fiyat (Adet) Price (Pcs)	EPDM Conta Kod EPDM O-Ring Code	Fiyat (Adet) Price (Pcs)	EPDM Conta Kod EPDM O-Ring Code	Fiyat (Adet) Price (Pcs)	EPDM Conta Kod EPDM O-Ring Code	Fiyat (Adet) Price (Pcs)
20	1/2"	410 20 020 2		410 50 020 2		410 70 020 2		418 70 020 2	
25	3/4"	410 10 025 2		410 50 025 2		410 70 025 2		418 70 025 2	
32	1"	410 10 032 2		410 50 032 2		410 70 032 2		418 70 032 2	
40	1 1/4"	410 10 040 2		410 50 040 2		410 70 040 2		418 70 040 2	
50	1 1/2"	410 10 050 2		410 50 050 2		410 70 050 2		418 70 050 2	
63	2"	410 10 063 2		410 50 063 2		410 70 063 2		418 70 063 2	

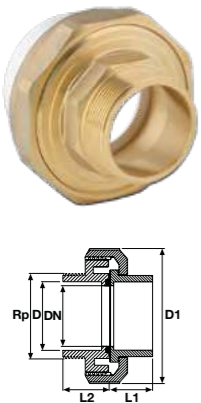
PP Rakor Dış Diş Pirinç Çıkışlı
 PP Union Male Threaded Brass Outlet

Çap Dia	Rp Inch	Basınç PN	Kg /Adet Kg/Pcs	Koli/Adet Box/Pcs	DN (mm)	D1 (mm)	L1 (mm)	L2 (mm)
20	1/2"	10	0,085	125	15	36	19	14
25	3/4"	10	0,14	100	20	45	22	15
32	1"	10	0,172	50	25	51	25	17
40	1 1/4"	10	0,34	50	32	64	28	24
50	1 1/2"	10	0,524	30	40	80	38	22
63	2"	10	0,68	24	50	98	41	23

beyaz / white

bej / beige

yeşil / green

mavi / blue

Çap Dia	Rp (Inch)	EPDM Conta Kod EPDM O-Ring Code	Fiyat (Adet) Price (Pcs)	EPDM Conta Kod EPDM O-Ring Code	Fiyat (Adet) Price (Pcs)	EPDM Conta Kod EPDM O-Ring Code	Fiyat (Adet) Price (Pcs)	EPDM Conta Kod EPDM O-Ring Code	Fiyat (Adet) Price (Pcs)
20	1/2"	410 10 020 2		410 45 020 2		410 65 020 2		418 65 020 2	
25	3/4"	410 10 025 2		410 45 025 2		410 65 025 2		418 65 025 2	
32	1"	410 10 032 2		410 45 032 2		410 65 032 2		418 65 032 2	
40	1 1/4"	410 10 040 2		410 45 040 2		410 65 040 2		418 65 040 2	
50	1 1/2"	410 10 050 2		410 45 050 2		410 65 050 2		418 65 050 2	
63	2"	410 10 063 2		410 45 063 2		410 65 063 2		418 65 063 2	

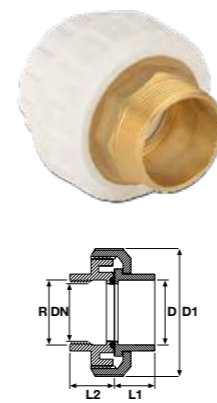
PP Rakor Dış Diş Pirinç Çıkışlı
 PP Union Male Threaded Brass Outlet

Çap Dia	R Inch	Basınç PN	Kg /Adet Kg/Pcs	Koli/Adet Box/Pcs	DN (mm)	D1 (mm)	L1 (mm)	L2 (mm)
20	1/2"	10	0,075	50	15	36	19	14
25	3/4"	10	0,108	100	20	45	22	15
32	1"	10	0,155	90	25	51	25	17
40	1 1/4"	10	0,28	80	32	64	28	24
50	1 1/2"	10	0,41	30	40	80	38	22
63	2"	10	0,77	24	50	98	41	23

beyaz / white

bej / beige

yeşil / green

mavi / blue

Çap Dia	Rp (Inch)	EPDM Conta Kod EPDM O-Ring Code	Fiyat (Adet) Price (Pcs)	EPDM Conta Kod EPDM O-Ring Code	Fiyat (Adet) Price (Pcs)	EPDM Conta Kod EPDM O-Ring Code	Fiyat (Adet) Price (Pcs)	EPDM Conta Kod EPDM O-Ring Code	Fiyat (Adet) Price (Pcs)
20	1/2"	410 30 020 2		410 55 020 2		410 75 020 2		418 75 020 2	
25	3/4"	410 30 025 2		410 55 025 2		410 75 025 2		418 75 025 2	
32	1"	410 30 032 2		410 55 032 2		410 75 032 2		418 75 032 2	
40	1 1/4"	410 30 040 2		410 55 040 2		410 75 040 2		418 75 040 2	
50	1 1/2"	410 30 050 2		410 55 050 2		410 75 050 2		418 75 050 2	
63	2"	410 30 063 2		410 55 063 2		410 75 063 2		418 75 063 2	

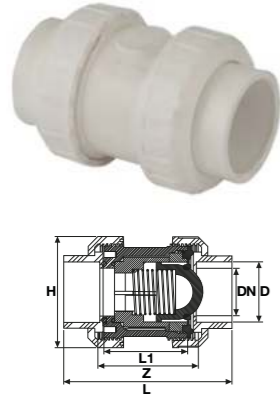
PP Yaylı Çekvalf
 PP Spring Checkvalve

Çap Dia	Basınç PN	Kg/Adet Kg/Pcs	Koli/Adet Box/Pcs	DN (mm)	H (mm)	L (mm)	L1 (mm)	Z (mm)
20	10	0,11	60	16	54	85	45	52
25	10	0,14	75	20	62	95	49	58
32	10	0,20	60	25	66	107	54	61
40	10	0,37	32	32	84	128	66	73
50	10	0,53	25	40	92	154	75	82
63	10	0,95	13	50	116	172	89	95
75	10	1,21	9	65	146	196	111	118
90	10	3,15	4	80	178	241	126	139
110	10	4,59	2	100	210	289	153	165

beyaz / white

bej / beige

yeşil / green

mavi / blue

Çap Dia	EPDM Conta Kod EPDM O-Ring Code	Fiyat (Adet) Price (Pcs)	EPDM Conta Kod EPDM O-Ring Code	Fiyat (Adet) Price (Pcs)	EPDM Conta Kod EPDM O-Ring Code	Fiyat (Adet) Price (Pcs)	EPDM Conta Kod EPDM O-Ring Code	Fiyat (Adet) Price (Pcs)
20	413 00 020 2		413 20 020 2		413 40 020 2		413 60 020 2	
25	413 00 025 2		413 20 025 2		413 40 025 2		413 60 025 2	
32	413 00 032 2		413 20 032 2		413 40 032 2		413 60 032 2	
40	413 00 040 2		413 20 040 2		413 40 040 2		413 60 040 2	
50	413 00 050 2		413 20 050 2		413 40 050 2		413 60 050 2	
63	413 00 063 2		413 20 063 2		413 40 063 2		413 60 063 2	
75	413 00 075 2		413 20 075 2		413 40 075 2		413 60 075 2	
90	413 00 090 2		413 20 090 2		413 40 090 2		413 60 090 2	
110	413 00 110 2		413 20 110 2		413 40 110 2		413 60 110 2	

PP Yaylı Çekvalf Çift Taraf İçten Dişli
 PP Spring Checkvalve Both Sides Female Threaded

Rp Inch	Basınç PN	Kg/Adet Kg/Pcs	Koli/Adet Box/Pcs	DN (mm)	H (mm)	L (mm)	L1 (mm)	Z (mm)
1/2"	10	0,11	60	16	54	85	45	52
3/4"	10	0,15	75	20	62	95	49	58
1"	10	0,19	60	25	66	107	54	61
1 1/4"	10	0,36	32	32	84	128	66	73
1 1/2"	10	0,55	20	40	92	154	75	82
2"	10	1,01	13	50	116	172	89	95
2 1/2"	10	1,24	9	65	146	196	111	118
3"	10	3,17	4	80	178	241	126	139
4"	10	4,45	2	100	210	289	153	165

beyaz / white

bej / beige

yeşil / green

mavi / blue

Rp Inch	EPDM Conta Kod EPDM O-Ring Code	Fiyat (Adet) Price (Pcs)	EPDM Conta Kod EPDM O-Ring Code	Fiyat (Adet) Price (Pcs)	EPDM Conta Kod EPDM O-Ring Code	Fiyat (Adet) Price (Pcs)	EPDM Conta Kod EPDM O-Ring Code	Fiyat (Adet) Price (Pcs)
1/2"	405 00 020 2		405 20 020 2		405 40 020 2		405 60 020 2	
3/4"	405 00 025 2		405 20 025 2		405 40 025 2		405 60 025 2	
1"	405 00 032 2		405 20 032 2		405 40 032 2		405 60 032 2	
1 1/4"	405 00 040 2		405 20 040 2		405 40 040 2		405 60 040 2	
1 1/2"	405 00 050 2		405 20 050 2		405 40 050 2		405 60 050 2	
2"	405 00 063 2		405 20 063 2		405 40 063 2		405 60 063 2	
2 1/2"	405 00 075 2		405 20 075 2		405 40 075 2		405 60 075 2	
3"	405 00 090 2		405 20 090 2		405 40 090 2		405 60 090 2	
4"	405 00 110 2		405 20 110 2		405 40 110 2		405 60 110 2	

PP Yaylı Çekvalf Tek Taraf İçten Dişli
 PP Spring Checkvalve One Side Female Threaded

Çap Dia	Rp Inch	Basınç PN	Kg/Adet Kg/Pcs	Koli/Adet Box/Pcs	DN (mm)	H (mm)	L (mm)	L1 (mm)	Z (mm)
20	1/2"	10	0,11	60	16	54	85	45	52
25	3/4"	10	0,14	75	20	62	95	49	58
32	1"	10	0,20	60	25	66	107	54	61
40	1 1/4"	10	0,37	32	32	84	128	66	73
50	1 1/2"	10	0,53	20	40	92	154	75	82
63	2"	10	0,95	13	50	116	172	89	95
75	2 1/2"	10	1,21	9	65	146	196	111	118
90	3"	10	3,15	4	80	178	241	126	139
110	4"	10	4,59	2	100	210	289	153	165

beyaz / white

bej / beige

yeşil / green

mavi / blue

Çap Dia	Rp Inch	EPDM Conta Kod EPDM O-Ring Code	Fiyat (Adet) Price (Pcs)	EPDM Conta Kod EPDM O-Ring Code	Fiyat (Adet) Price (Pcs)	EPDM Conta Kod EPDM O-Ring Code	Fiyat (Adet) Price (Pcs)	EPDM Conta Kod EPDM O-Ring Code	Fiyat (Adet) Price (Pcs)
20	1/2"	404 00 020 2		404 20 020 2		404 40 020 2		404 60 020 2	
25	3/4"	404 00 025 2		404 20 025 2		404 40 025 2		404 60 025 2	
32	1"	404 00 032 2		404 20 032 2		404 40 032 2		404 60 032 2	
40	1 1/4"	404 00 040 2		404 20 040 2		404 40 040 2		404 60 040 2	
50	1 1/2"	404 00 050 2		404 20 050 2		404 40 050 2		404 60 050 2	
63	2"	404 00 063 2		404 20 063 2		404 40 063 2		404 60 063 2	
75	2 1/2"	404 00 075 2		404 20 075 2		404 40 075 2		404 60 075 2	
90	3"	404 00 090 2		404 20 090 2		404 40 090 2		404 60 090 2	
110	4"	404 00 110 2		404 20 110 2		404 40 110 2		404 60 110 2	

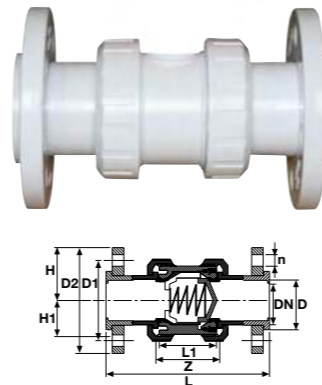
PP Yaylı Çekvalf Flanş Bağlantılı
 PP Spring Checkvalve Both Sides Flanged

Çap Dia	Basınç PN	Kg/Adet Kg/Pcs	Koli/Adet Box/Pcs	DN (mm)	Z (mm)	L1 (mm)	L (mm)	H (mm)	D1 (mm)	D2 (mm)	n (mm)
20	10		60	16	52	45	123	54	65	96	14x4
25	10		75	20	58	49	140	62	75	105	14x4
32	10		60	25	61	54	158	66	85	115	14x4
40	10		32	32	73	66	186	84	100	140	14x4
50	10		24	40	82	75	231	92	100	150	18x4
63	10		13	50	95	89	253	116	125	165	18x4
75	10		9	65	118	111	291	146	145	185	18x4
90	10		4	80	139	126	353	178	160	200	18x8
110	10		2	100	165	153	431	210	180	220	18x8

beyaz / white

bej / beige

yeşil / green

mavi / blue

Çap Dia	EPDM Conta Kod EPDM O-Ring Code	Fiyat (Adet) Price (Pcs)	EPDM Conta Kod EPDM O-Ring Code	Fiyat (Adet) Price (Pcs)	EPDM Conta Kod EPDM O-Ring Code	Fiyat (Adet) Price (Pcs)	EPDM Conta Kod EPDM O-Ring Code	Fiyat (Adet) Price (Pcs)
20	405 10 020 2		405 50 020 2		405 30 020 2		405 70 020 2	
25	405 10 025 2		405 50 025 2		405 30 025 2		405 70 025 2	
32	405 10 032 2		405 50 032 2		405 30 032 2		405 70 032 2	
40	405 10 040 2		405 50 040 2		405 30 040 2		405 70 040 2	
50	405 10 050 2		405 50 050 2		405 30 050 2		405 70 050 2	
63	405 10 063 2		405 50 063 2		405 30 063 2		405 70 063 2	
75	405 10 075 2		405 50 075 2		405 30 075 2		405 70 075 2	
90	405 10 090 2		405 50 090 2		405 30 090 2		405 70 090 2	
110	405 10 110 2		405 50 110 2		405 30 110 2		405 70 110 2	

Beyaz ürün harici diğer renklerde minimum adet için lütfen sorunuz. Please inquire minimum quantity for other colors except white color.

Beyaz ürün harici diğer renklerde minimum adet için lütfen sorunuz. Please inquire minimum quantity for other colors except white color.

PP Çalparalı Çekvalf Çıplak
PP Wafer Checkvalve Without Flange

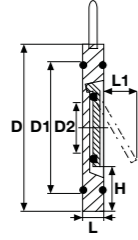

Düşük Dayanımlı Asit İçin
For Low Strength Acid

Yüksek Dayanımlı Asit İçin
For High Strength Acid

Çap Dia	Basınç PN	EPDM Conta Kod EPDM O-Ring Code	Fiyat (Adet) Price (Pcs)	FPM Conta Kod FPM O-Ring Code	Fiyat (Adet) Price (Pcs)	Kg /Adet Kg/Pcs	Koli/Ad. Box/Pcs	DN (mm)	D (mm)	D1 (mm)	D2 (mm)	L (mm)	L1 (mm)	H (mm)
63	10	428 01 063 2		428 02 063 2			5	50	90	75	32	16	40	18
75	10	428 01 075 2		428 02 075 2			5	65	110	95	40	16	55	20
90	10	428 01 090 2		428 02 090 2			5	80	125	115	54	16	67	23
110	10	428 01 110 2		428 02 110 2			5	100	184	135	70	19	67	35
125	10	428 01 125 2		428 02 125 2			5	100	213	160	92	21	94	37
140	10	428 01 140 2		428 02 140 2			5	125	213	160	92	21	94	37
160	10	428 01 160 2		428 02 160 2			5	150	251	175	105	23	100	47
200	10	428 01 200 2		428 02 200 2			5	200	280	235	155	27	152	41
225	10	428 01 225 2		428 02 225 2			5	200	280	235	155	27	152	41
250	10	428 01 250 2		428 02 250 2			5	250	330	285	190	40	180	41
280	10	428 01 280 2		428 02 280 2			5	250	330	285	190	40	180	41
315	10	428 01 315 2		428 02 315 2			5	300	380	325	235	45	215	41
400	10	428 01 400 2		428 02 400 2			5							

PP Flanş Bağlantılı Çalparalı Çekvalf (Takım - 304 Paslanmaz Civata, Somun, Pul)
PP Wafer Checkvalve With Flange (304 S.S. Screw, Nut, Washer)

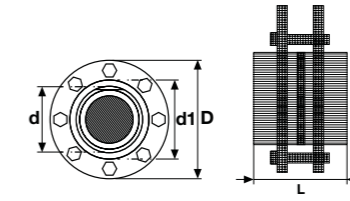

Düşük Dayanımlı Asit İçin
For Low Strength Acid

Yüksek Dayanımlı Asit İçin
For High Strength Acid

Çap Dia	Basınç PN	EPDM Conta Kod EPDM O-Ring Code	Fiyat (Adet) Price (Pcs)	FPM Conta Kod FPM O-Ring Code	Fiyat (Adet) Price (Pcs)	Kg /Adet Kg/Pcs	Koli/Ad. Box/Pcs	DN (mm)	D1 (mm)	D (mm)	L (mm)	nQe (mm)
63	10	428 04 063 2		428 05 063 2		3,10	8	50	77	165	90	4 x 16
75	10	428 04 075 2		428 05 075 2		3,40	4	65	90	185	110	4 x 16
90	10	428 04 090 2		428 05 090 2		3,71	4	80	107	200	126	8 x 16
110	10	428 04 110 2		428 05 110 2		4,56	4	100	129	220	155	8 x 16
125	10	428 04 125 2		428 05 125 2		5,55	2	100	147	250	173	8 x 16
140	10	428 04 140 2		428 05 140 2		5,77	2	125	164	250	182	8 x 16
160	10	428 04 160 2		428 05 160 2		7,47	2	150	188	285	209	8 x 20
200	10	428 04 200 2		428 05 200 2		10,0	1	200	230	340	253	8 x 20
225	10	428 04 225 2		428 05 225 2		10,1	1	200	245	340	285	8 x 20
250	10	428 04 250 2		428 05 250 2		20,6	1	250	269	395	375	12 x 20
280	10	428 04 280 2		428 05 280 2		20,5	1	250	304	395	375	12 x 20
315	10	428 04 315 2		428 05 315 2		25,1	1	300	341	445	415	12 x 20
400	10	428 04 400 2		428 05 400 2			1	400	450	565	482	16 x 24

PP Çalparalı Çekvalf Flanş Bağlantılı
PP Wafer Checkvalve With Flange

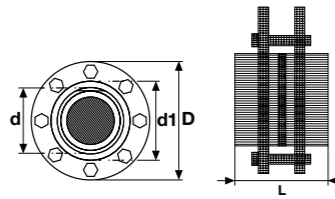

Düşük Dayanımlı Asit İçin
For Low Strength Acid

Yüksek Dayanımlı Asit İçin
For High Strength Acid

Çap Dia	Basınç PN	EPDM Conta Kod EPDM O-Ring Code	Fiyat (Adet) Price (Pcs)	FPM Conta Kod FPM O-Ring Code	Fiyat (Adet) Price (Pcs)	Kg /Adet Kg/Pcs	Koli/Ad. Box/Pcs	DN (mm)	D1 (mm)	D (mm)	L (mm)	nQe (mm)
63	10	428 00 063 2		428 03 063 2		1,83	8	50	77	165	90	4 x 16
75	10	428 00 075 2		428 03 075 2		2,31	4	65	90	185	110	4 x 16
90	10	428 00 090 2		428 03 090 2		3,75	4	80	107	200	126	8 x 16
110	10	428 00 110 2		428 03 110 2		4,35	4	100	129	220	155	8 x 16
125	10	428 00 125 2		428 03 125 2		5,35	2	100	147	250	173	8 x 16
140	10	428 00 140 2		428 03 140 2		5,87	2	125	164	250	182	8 x 16
160	10	428 00 160 2		428 03 160 2		7,03	2	150	188	285	209	8 x 20
200	10	428 00 200 2		428 03 200 2		10,0	1	200	230	340	253	8 x 20
225	10	428 00 225 2		428 03 225 2		10,5	1	200	245	340	285	8 x 20
250	10	428 00 250 2		428 03 250 2		16,2	1	250	269	395	375	12 x 20
280	10	428 00 280 2		428 03 280 2		15,5	1	250	304	395	375	12 x 20
315	10	428 00 315 2		428 03 315 2		19,8	1	300	341	445	415	12 x 20
400	10	428 00 400 2		428 03 400 2			1	400	450	565	482	16 x 24

PP Flanş Bağlantılı Çalparalı Çekvalf (Takım - 316 Paslanmaz Civata, Somun, Pul)
PP Wafer Checkvalve With Flange (316 S.S. Screw, Nut, Washer)

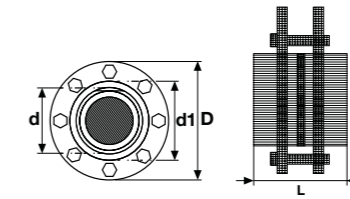

Düşük Dayanımlı Asit İçin
For Low Strength Acid

Yüksek Dayanımlı Asit İçin
For High Strength Acid

Çap Dia	Basınç PN	EPDM Conta Kod EPDM O-Ring Code	Fiyat (Adet) Price (Pcs)	FPM Conta Kod FPM O-Ring Code	Fiyat (Adet) Price (Pcs)	Kg /Adet Kg/Pcs	Koli/Ad. Box/Pcs	DN (mm)	D1 (mm)	D (mm)	L (mm)	nQe (mm)
63	10	428 06 063 2		428 07 063 2		3,10	8	50	77	165	90	4 x 16
75	10	428 06 075 2		428 07 075 2		3,40	4	65	90	185	110	4 x 16
90	10	428 06 090 2		428 07 090 2		3,71	4	80	107	200	126	8 x 16
110	10	428 06 110 2		428 07 110 2		4,56	4	100	129	220	155	8 x 16
125	10	428 06 125 2		428 07 125 2		5,55	2	100	147	250	173	8 x 16
140	10	428 06 140 2		428 07 140 2		5,77	2	125	164	250	182	8 x 16
160	10	428 06 160 2		428 07 160 2		7,47	2	150	188	285	209	8 x 20
200	10	428 06 200 2		428 07 200 2		10,0	1	200	230	340	253	8 x 20
225	10	428 06 225 2		428 07 225 2		10,1	1	200	245	340	285	8 x 20
250	10	428 06 250 2		428 07 250 2		20,6	1	250	269	395	375	12 x 20
280	10	428 06 280 2		428 07 280 2		20,5	1	250	304	395	375	12 x 20
315	10	428 06 315 2		428 07 315 2		25,1	1	300	341	445	415	12 x 20
400	10	428 06 400 2		428 07 400 2			1	400	450	565	482	16 x 24

PP Kole
 PP Flange Adaptor

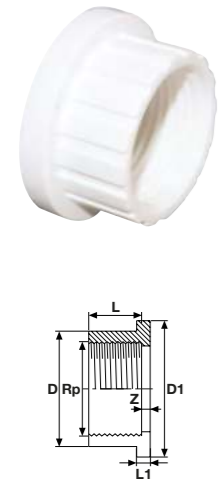

d mm	Basıncı PN	Kod Code	Fiyat (Adet) Price (Pcs)	Kg /Adet Kg/Pcs	Koli/Adet Box/Pcs	DN1 (mm)	D (mm)	D1 (mm)	L (mm)	L1 (mm)	Z (mm)
20	10	512 03 020 2		0,009	750	15	27	34,0	16,0	7	3
25	10	512 03 025 2		0,01	450	20	33	41,0	19,0	7	3
32	10	512 03 032 2		0,02	250	25	41	50,0	22,0	7	3
40	10	512 03 040 2		0,04	150	32	50	61,0	26,0	8	3
50	10	512 03 050 2		0,06	160	40	60	73,0	31,0	8	3
63	10	512 03 063 2		0,09	100	50	77	91,0	38,0	9	3
75	10	512 03 075 2		0,16	70	65	90	106,0	43,5	10	3
90	10	512 03 090 2		0,23	85	80	107	125,0	51,0	11	5
110	10	512 03 110 2		0,41	45	100	129	150,0	61,0	12	5
125	10	512 03 125 2		0,60	24	110	147	170,0	69,0	13	5
140	10	512 03 140 2		0,78	18	125	164	188,0	76,0	14	5
160	10	512 03 160 2		1,10	16	150	188	213,0	86,0	16	5

PP İç Dişli Kole
 PP Female Threaded Flange Adaptor

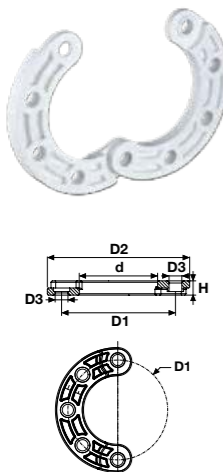
Rp Inch	Basıncı PN	Kod Code	Fiyat (Adet) Price (Pcs)	Kg /Adet Kg/Pcs	Koli/Adet Box/Pcs	DN (mm)	D (mm)	D1 (mm)	L (mm)	L1 (mm)	Z (mm)
1/2"	10	512 04 020 2		0,01	750	15	27	34,0	16,0	7	3
3/4"	10	512 04 025 2		0,01	450	20	33	41,0	19,0	7	3
1"	10	512 04 032 2		0,02	250	25	41	50,0	22,0	7	3
1 1/4"	10	512 04 040 2		0,03	150	32	50	61,0	26,0	8	3
1 1/2"	10	512 04 050 2		0,07	160	40	60	73,0	35,0	8	3
2"	10	512 04 063 2		0,13	100	50	77	91,0	38,0	9	3
2 1/2"	10	512 04 075 2		0,12	60	65	90	106,0	43,0	10	3
3"	10	512 04 090 2		0,27	85	80	107	125,0	51,0	11	5
4"	10	512 04 110 2		0,35	45	100	129	150,0	60,0	12	5

PP Tamir Flanş
 PP Repair Flange

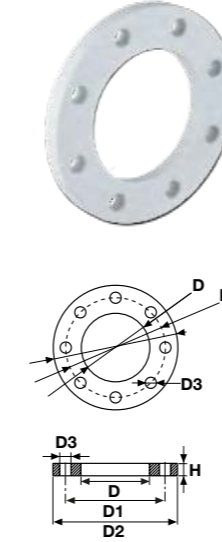
d (mm)	Basıncı PN	Kod Code	Fiyat (Adet) Price (Pcs)	Kg /Adet Kg/Pcs	Koli/Adet Box/Pcs	D1 (mm)	D2 (mm)	D3 (mm)	H (mm)
90	10	513 06 090 2			35	160	200	18	20
110	10	513 06 110 2			22	180	220	18	22
125	10	513 06 125 2		0,615	18	210	250	18,5	25
140	10	513 06 140 2		0,560	18	210	250	18	25,5
160	10	513 06 160 2		0,600	14	240	285	22	28
200	10	513 06 200 2		1,130	11	295	340	22	30

PP Flanş
 PP Flange

d mm	Basıncı PN	Kod Code	Fiyat (Adet) Price (Pcs)	Kg /Adet Kg/Pcs	Koli/Adet Box/Pcs	DN (mm)	D (mm)	D1 (mm)	D2 (mm)	D3 (mm)	H (mm)	N (Adet)
20	10	513 01 020 2		0,10	150	15	28	65	96	14	11	4
25	10	513 01 025 2		0,12	100	20	34	75	105	14	12	4
32	10	513 01 032 2		0,18	80	25	42	85	115	14	14	4
40	10	513 01 040 2		0,29	50	32	51	100	140	14	15	4
50	10	513 01 050 2		0,29	48	40	62	110	150	18	16	4
63	10	513 01 063 2		0,30	25	50	78	125	165	18	18	4
75	10	513 01 075 2		0,40	40	65	92	145	185	18	20	4
90	10	513 01 090 2		0,46	35	80	111	160	200	18	22	8
110	10	513 01 110 2		0,53	22	100	133	180	220	18	24	8
125	10	513 01 125 2		0,78	18	110	150	210	250	18	26	8
140	10	513 01 140 2		0,74	18	125	167	210	250	18	26	8
160	10	513 01 160 2		0,81	14	150	193	250	285	22	28	8
200	10	513 01 200 2		1,67	8	175	234	295	340	22	32	8
225	10	513 01 225 2		1,82	8	200	257	295	340	22	32	8
250	10	513 01 250 2		2,19	7	250	278	325	370	22	36	8
280	10	513 01 280 2		2,32	7	250	310	350	395	22	36	12
315	10	513 01 315 2		2,96	7	300	348	400	445	22	36	12
355	10	513 01 355 2			1	350	388	460	505	22	38	16
400	10	513 01 400 2			1	400	442	515	565	26	42	16

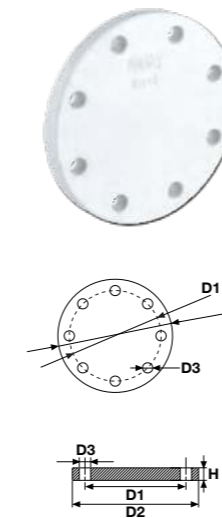
PP Kör Flanş
 PP Blind Flange

d mm	Basıncı PN	Kod Code	Fiyat (Adet) Price (Pcs)	Kg /Adet Kg/Pcs	Koli/Adet Box/Pcs	DN (mm)	D1 (mm)	D2 (mm)	D3 (mm)	H (mm)	N (Adet)
20	10	514 01 020 2		0,09	150	15	65	96	14	12	4
25	10	514 01 025 2		0,14	110	20	75	105	14	13	4
32	10	514 01 032 2		0,17	80	25	85	115	14	15	4
40	10	514 01 040 2		0,28	50	32	100	140	14	16	4
50	10	514 01 050 2		0,37	48	40	110	150	18	17	4
63	10	514 01 063 2		0,57	25	50	125	165	18	20	4
75	10	514 01 075 2			40	65	145	185	18	21	4
90	10	514 01 090 2			35	80	160	200	18	22	8
110	10	514 01 110 2			22	100	180	220	18	24	8
125	10	514 01 125 2		1,628	18	125	210	250	18	28	8
140	10	514 01 140 2		1,628	18	125	210	250	18	28	8
160	10	514 01 160 2		2,586	18	150	250	285	22	28	8
200	10	514 01 200 2		3,82	14	200	295	340	22	32	8
225	10	514 01 225 2		3,82	8	200	295	340	22	32	8
250	10	514 01 250 2			8	250	350	395	22	36	8
280	10	514 01 280 2			8	250	350	395	22	36	12
315	10	514 01 315 2			7	300	400	445	22	36	12
355	10	514 01 355 2			7	350	460	505	22	38	16
400	10	514 01 400 2			7	400	515	565	26	40	16

Not / Note

PPRC

ÜRÜN GRUBU

PRODUCT LINE

ÜRETİM STANDARDI

PRODUCTION STANDARD

TS EN ISO 15874-3

ÇAP / SIZE Ø20 - Ø125

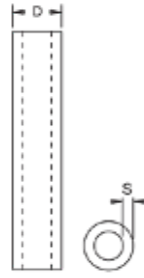

PP-R Boru
 PP-R Pipe

PN 10

Çap Dia	Basınç Pn	Kod Code	Fiyat (Adet) Price (Pcs)	Min. Sipariş Adet Min. Order Quant.	L (m)	S	D
20	10	800 00 020 2		140	4	1.9	20.3
25	10	800 00 025 2		100	4	2.3	25.3
32	10	800 00 032 2		60	4	2.9	32.3
40	10	800 00 040 2		40	4	3.7	40.4
50	10	800 00 050 2		24	4	4.6	50.5
63	10	800 00 063 2		20	4	5.8	63.6
75	10	800 00 075 2		12	4	6.8	75.7
90	10	800 00 090 2		8	4	8.2	90.9
110	10	800 00 110 2		4	4	10	111
125	10	800 00 125 2		4	4	11.4	126.2

PN 16

Çap Dia	Basınç Pn	Kod Code	Fiyat (Adet) Price (Pcs)	Min. Sipariş Adet Min. Order Quant.	L (m)	S	D
20	16	800 01 020 2		140	4	2.8	20.3
25	16	800 01 025 2		100	4	3.5	25.3
32	16	800 01 032 2		60	4	4.4	32.3
40	16	800 01 040 2		40	4	5.5	40.4
50	16	800 01 050 2		24	4	6.9	50.5
63	16	800 01 063 2		20	4	8.6	63.6
75	16	800 01 075 2		12	4	10.3	75.7
90	16	800 01 090 2		8	4	12.3	90.9
110	16	800 01 110 2		4	4	15.1	111
125	16	800 01 125 2		4	4	17.1	126.2

PN 20

Çap Dia	Basınç Pn	Kod Code	Fiyat (Adet) Price (Pcs)	Min. Sipariş Adet Min. Order Quant.	L (m)	S	D
20	20	800 02 020 2		140	4	3.4	20.3
25	20	800 02 025 2		100	4	4.2	25.3
32	20	800 02 032 2		60	4	5.4	32.3
40	20	800 02 040 2		40	4	6.7	40.4
50	20	800 02 050 2		24	4	8.3	50.5
63	20	800 02 063 2		20	4	10.5	63.6
75	20	800 02 075 2		12	4	12.5	75.7
90	20	800 02 090 2		8	4	15.0	90.9
110	20	800 02 110 2		4	4	18.3	111
125	20	800 02 125 2		4	4	20.8	126.2

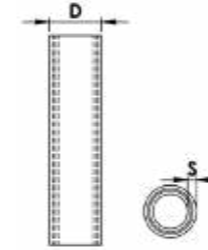
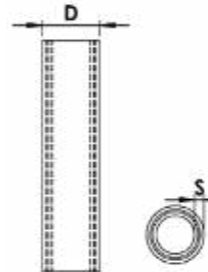
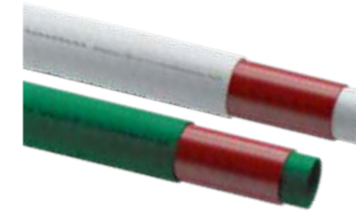
PP-R Foroxi Boru
 PP-R Foroxi Pipe

PP-R Kompozit Boru
 PP-R Composite Pipe

PN 25

Çap Dia	Basınç Pn	Kod Code	Fiyat (Adet) Price (Pcs)	Koli/Adet Box/Pcs	S	D
20	25	800 03 020 2		140/4.00	3.4	20.3
25	25	800 03 025 2		100/4.00	4.2	25.3
32	25	800 03 032 2		60/4.00	5.4	32.3
40	25	800 03 040 2		40/4.00	6.7	40.4
50	25	800 03 050 2		24/4.00	8.3	50.5
63	25	800 03 063 2		20/4.00	10.5	63.6
75	25	800 03 075 2		12/4.00	12.5	75.7
90	25	800 03 090 2		8/4.00	15.0	90.9
110	25	800 03 110 2		44.00	18.3	111
125	25	800 03 125 2		4/4.00	20.8	126.2

PN 20

Çap Dia	Basınç Pn	Kod Code	Fiyat (Adet) Price (Pcs)	Koli/Adet Box/Pcs	S	D
20	20	800 04 020 2		140/4.00	2.8	20.3
25	20	800 04 025 2		100/4.00	3.5	25.3
32	20	800 04 032 2		60/4.00	4.4	32.3
40	20	800 04 040 2		40/4.00	5.5	40.4
50	20	800 04 050 2		24/4.00	6.9	50.5
63	20	800 04 063 2		20/4.00	8.6	63.6
75	20	800 04 075 2		12/4.00	10.3	75.7
90	20	800 04 090 2		8/4.00	12.3	90.9
110	20	800 04 110 2		44.00	15.1	111
125	20	800 04 125 2		4/4.00	17.1	126.2

PN 25

Çap Dia	Basınç Pn	Kod Code	Fiyat (Adet) Price (Pcs)	Koli/Adet Box/Pcs	S	D
20	25	800 05 020 2		140/4.00	3.4	20.3
25	25	800 05 025 2		100/4.00	4.2	25.3
32	25	800 05 032 2		60/4.00	5.4	32.3
40	25	800 05 040 2		40/4.00	6.7	40.4
50	25	800 05 050 2		24/4.00	8.3	50.5
63	25	800 05 063 2		20/4.00	10.5	63.6
75	25	800 05 075 2		12/4.00	12.5	75.7
90	25	800 05 090 2		8/4.00	15.0	90.9
110	25	800 05 110 2		44.00	18.3	111
125	25	800 05 125 2		4/4.00	20.8	126.2

PP-R Omega
PP-R Omega



Çap Dia	Basınç Pn	Kod Code	Fiyat (Adet) Price (Pcs)	Koli/Adet Box/Pcs	S	D	L
20	16	802 00 020		85	3.4	20.3	350
25	16	802 00 025		45	4.2	25.3	350
32	16	802 00 032		22	5.4	32.3	350
40	16	802 00 040		15	6.7	40.4	350

PP-R Kavis
PP-R Crossover

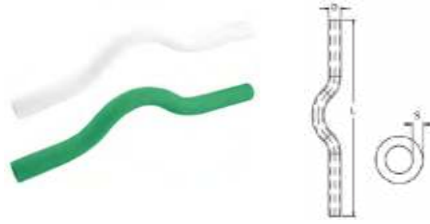

Çap Dia	Basınç Pn	Kod Code	Fiyat (Adet) Price (Pcs)	Koli/Adet Box/Pcs	S	D	L
20	16	801 07 020		160	3.4	20.3	350
25	16	801 07 025		100	4.2	25.3	350
32	16	801 07 032		65	5.4	32.3	350
40	16	801 07 040		40	6.7	40.4	350

PP-R Kavis Manşonlu - Uzun
PP-R Crossover With Socket - Long

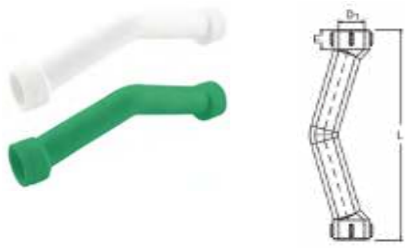

Çap Dia	Basınç Pn	Kod Code	Fiyat (Adet) Price (Pcs)	Koli/Adet Box/Pcs	D1	E	L
20	16	801 08 020		160	19.5	20.3	350
25	16	801 08 025		100	24.5	25.3	350
32	16	801 08 032		65	31.5	32.3	350

PP-R Kavis Manşonlu - Kısa (C Tip)
PP-R Crossover with Socket - Short



Çap Dia	Basınç Pn	Kod Code	Fiyat (Adet) Price (Pcs)	Koli/Adet Box/Pcs	d1	E	L
20	16	801 09 020		200	19.5	14.5	86
25	16	801 09 025		125	24.5	16	95
32	16	801 09 032		60	31.5	18	117

PP-R Kavisli Dirsek
PP-R Bend



Çap Dia	Basınç Pn	Kod Code	Fiyat (Adet) Price (Pcs)	Koli/Adet Box/Pcs	d1	E	L
25	16	800 09 025 2		125	24.5	16	66
32	16	800 09 032 2		60	31.5	18	83

PP-R Uzun Te
PP-R Long Tee



Çap Dia	Basınç Pn	Kod Code	Fiyat (Adet) Price (Pcs)	Koli/Adet Box/Pcs	S	D	L1	L2
20	16	801 10 020		100	19.5	14.5	49	146
25	16	801 10 025		70	24.5	16	59	163

PP-R Manşon
PP-R Socket

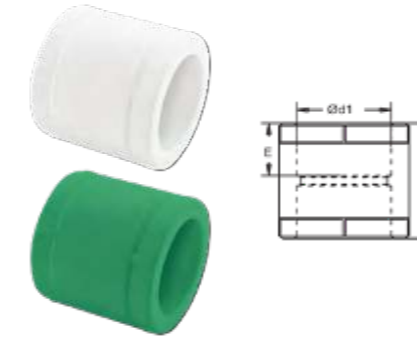

Çap Dia	Basınç Pn	Kod Code	Fiyat (Adet) Price (Pcs)	Koli/Adet Box/Pcs	d1	E	L
20	16	800 05 020 2		600	19.5	14.5	34
25	16	800 05 025 2		300	24.5	16	37
32	16	800 05 032 2		200	31.5	18	41
40	16	800 05 040 2		100	39.4	20.5	45
50	16	800 05 050 2		60	49.4	23.5	52
63	16	800 05 063 2		36	62.5	27.5	60
75	16	800 05 075 2		24	74.2	31	65
90	16	800 05 090 2		16	89.2	35.5	71
110	16	800 05 110 2		6	109	41.5	79
125	16	800 05 125 2		4	123.9	46.5	104

PP-R Redüksiyon Manşon
PP-R Reducer Socket

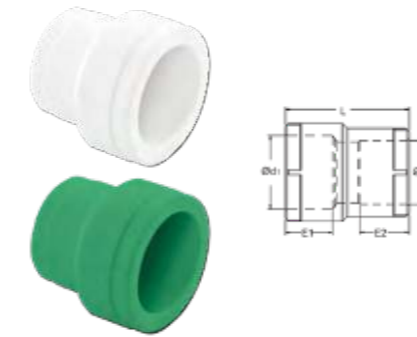

Çap Dia	Basınç Pn	Kod Code	Fiyat (Adet) Price (Pcs)	Koli/Adet Box/Pcs	d1	d2	E1	E2	L
25/20	16	810 00 2520 2		400	24.5	19.5	16	14.5	35
32/20	16	810 00 3220 2		300	31.5	19.5	18	14.5	38
32/25	16	810 00 3225 2		250	31.5	24.5	18	16	40
40/20	16	810 00 4020 2		150	39.4	19.5	20.5	14.5	47
40/25	16	810 00 4025 2		150	39.4	24.5	20.5	16	47
40/32	16	810 00 4032 2		125	39.4	31.5	20.5	18	47
50/20	16	810 00 5020 2		100	49.4	19.5	23.5	14.5	50
50/25	16	810 00 5025 2		100	49.4	24.5	23.5	16	50
50/32	16	810 00 5032 2		80	49.4	31.5	23.5	18	50
50/40	16	810 00 5040 2		75	49.4	39.4	23.5	20.5	50
63/20	16	810 00 6320 2		40	62.5	19.5	27.5	14.5	60
63/25	16	810 00 6325 2		40	62.5	24.5	27.5	16	60
63/32	16	810 00 6332 2		40	62.5	31.5	27.5	18	60
63/40	16	810 00 6340 2		40	62.5	39.4	27.5	20.5	65
63/50	16	810 00 6350 2		35	62.5	49.4	27.5	23.5	66

PP-R Redüksiyon
PP-R Reducer

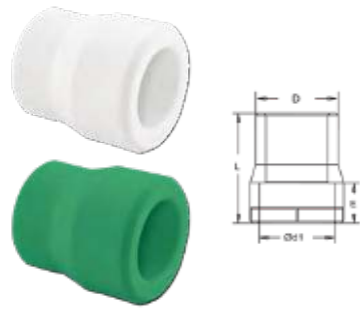

Çap Dia	Basınç Pn	Kod Code	Fiyat (Adet) Price (Pcs)	Koli/Adet Box/Pcs	d1	E	D	L
25/20	16	801 03 2520 2		500	19.5	14.5	25	39
32/20	16	801 03 3220 2		400	19.5	14.5	32	39
32/25	16	801 03 3225 2		300	24.5	16	32	43
40/20	16	801 03 4020 2		200	19.5	14.5	40	39
40/25	16	801 03 4025 2		200	24.5	16	40	43
40/32	16	801 03 4032 2		150	31.5	18	40	48
50/25	16	801 03 5025 2		100	24.5	16	50	43
50/32	16	801 03 5032 2		100	31.5	18	50	48
50/40	16	801 03 5040 2		80	39.4	20.5	50	52
63/32	16	801 03 6332 2		60	31.5	18	63	48
63/40	16	801 03 6340 2		60	39.4	20.5	63	52
63/50	16	801 03 6350 2		50	49.4	23.5	63	60
75/40	16	801 03 7540 2		40	39.4	20.5	75	52
75/50	16	801 03 7550 2		40	49.4	23.5	75	60
75/63	16	801 03 7563 2		30	62.5	27.5	75	67
90/50	16	801 03 9050 2		20	49.4	23.5	90	60
90/63	16	801 03 9063 2		20	62.5	27.5	90	67
90/75	16	801 03 9075 2		16	74.2	31	90	72
110/63	16	801 03 11063 2		16	62.5	27.5	110	67
110/75	16	801 03 11075 2		16	74.2	31	110	72
110/90	16	801 03 11090 2		16	89.2	35.5	110	90
125/90	16	801 03 12590 2		6	89.2	35.5	125	120
125/110	16	801 03 125110 2		5	109	41.5	125	120

PP-R 90° Dirsek
PP-R 90° Elbow

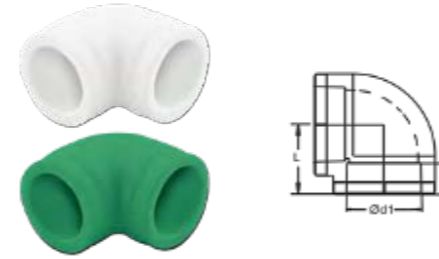

Çap Dia	Basınç Pn	Kod Code	Fiyat (Adet) Price (Pcs)	Koli/Adet Box/Pcs	d1	E	L
20	16	800 07 020 2		400	19.5	14.5	23
25	16	800 07 025 2		250	24.5	16	25
32	16	800 07 032 2		125	31.5	18	28
40	16	800 07 040 2		60	39.4	20.5	32
50	16	800 07 050 2		35	49.4	23.5	37
63	16	800 07 063 2		15	62.5	27.5	54
75	16	800 07 075 2		12	74.2	31	60
90	16	800 07 090 2		6	89.2	35.5	76
110	16	800 07 110 2		2	109	41.5	94
125	16	800 07 125 2		2	123.9	46.5	110

PP-R 45° Dirsek
PP-R 45° Elbow

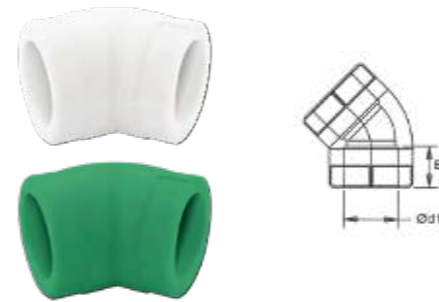

Çap Dia	Basınç Pn	Kod Code	Fiyat (Adet) Price (Pcs)	Koli/Adet Box/Pcs	d1	E
20	16	800 06 020 2		500	19.5	14.5
25	16	800 06 025 2		300	24.5	16
32	16	800 06 032 2		125	31.5	18
40	16	800 06 040 2		80	39.4	20.5
50	16	800 06 050 2		40	49.4	23.5
63	16	800 06 063 2		20	62.5	27.5
75	16	800 06 075 2		15	74.2	31
90	16	800 06 090 2		8	89.2	35.5
110	16	800 06 110 2		4	109	41.5

PP-R 90° Redüksiyon Dirsek
PP-R 90° Reducer Elbow



Çap Dia	Basınç Pn	Kod Code	Fiyat (Adet) Price (Pcs)	Koli/Adet Box/Pcs	d1	d2	E1	E2	L
25/20	16	800 09 2520 2		200	24.5	19.5	16	14.5	29
32/25	16	800 09 3225 2		150	31.5	24.5	18	16	33

PP-R 45° Kuyruklu Dirsek
PP-R 45° Tail Elbow



Çap Dia	Basınç Pn	Kod Code	Fiyat (Adet) Price (Pcs)	Koli/Adet Box/Pcs	d1	d2	E
20	16	800 08 020 2		300	19.5	20.3	14.5
25	16	800 08 025 2		200	24.5	25.3	16
32	16	800 08 032 2		100	31.5	32.3	18

PP-R 90° Kuyruklu Dirsek
PP-R 90° Tail Elbow

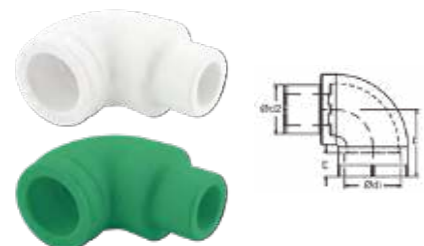

Çap Dia	Basınç Pn	Kod Code	Fiyat (Adet) Price (Pcs)	Koli/Adet Box/Pcs	d1	d2	E	L
20	16	800 18 020 2		300	19.5	20.3	14.5	23
25	16	800 18 025 2		200	24.5	25.3	16	25
32	16	800 18 032 2		100	31.5	32.3	18	28

PP-R Te
PP-R Tee

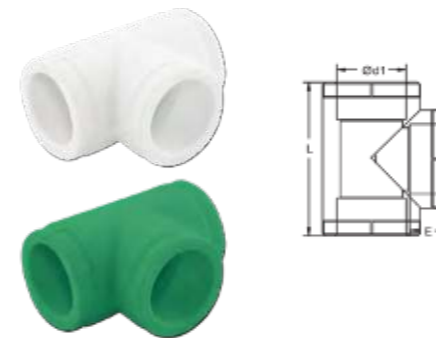

Çap Dia	Basınç Pn	Kod Code	Fiyat (Adet) Price (Pcs)	Koli/Adet Box/Pcs	d1	E	L
20	16	801 00 020 2		250	19.5	14.5	52
25	16	801 00 025 2		150	24.5	16	59
32	16	801 00 032 2		80	31.5	18	70
40	16	801 00 040 2		40	39.4	20.5	82
50	16	801 00 050 2		25	49.4	23.5	100
63	16	801 00 063 2		16	62.5	27.5	120
75	16	801 00 075 2		10	74.2	31	137
90	16	801 00 090 2		5	89.2	35.5	160
110	16	801 00 110 2		2	109	41.5	190
125	16	801 00 125 2		2	123.9	46.5	221

PP-R İnegal Te
PP-R Reducer Tee

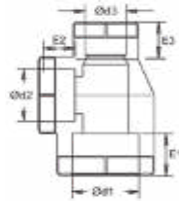

Çap Dia	Basınç Pn	Kod Code	Fiyat (Adet) Price (Pcs)	Koli/Adet Box/Pcs	d1	E1	d2	E2	d3	E3
20/25/20	16	801 01 202520		200	19.5	14.5	24.5	16	19.5	14.5
25/20/20	16	801 01 252020		150	24.5	16	19.5	14.5	19.5	14.5
25/20/25	16	801 01 252025		200	24.5	16	19.5	14.5	524.5	16
25/25/20	16	801 01 252520		150	24.5	16	24.5	16	19.5	14.5
32/20/20	16	801 01 322020		100	31.5	18	19.5	14.5	19.5	14.5
32/20/25	16	801 01 322025		100	31.5	18	19.5	14.5	24.5	16
32/20/32	16	801 01 322032		100	31.5	18	19.5	14.5	31.5	18
32/25/20	16	801 01 322520		100	31.5	18	24.5	16	19.5	14.5
32/25/25	16	801 01 322525		100	31.5	18	24.5	16	24.5	16.0
32/25/32	16	801 01 322532		100	31.4	18	24.5	16	31.5	18
40/20/40	16	801 01 402040		50	39.4	20.5	19.5	14.5	39.4	20.5
40/25/40	16	801 01 402540		50	39.4	20.5	24.5	16	39.4	20.5
40/32/40	16	801 01 403240		40	39.4	20.5	31.5	18	39.4	20.5
50/20/50	16	801 01 502050		30	49.4	23.5	19.5	14.5	49.4	23.5
50/25/50	16	801 01 502550		30	49.4	23.5	24.5	16	49.4	23.5
50/32/50	16	801 01 503250		30	49.4	23.5	31.5	18	49.4	23.5
50/40/50	16	801 01 504050		25	49.4	523.5	39.4	20.5	49.4	23.5
63/20/63	16	801 01 632063		24	62.5	27.5	19.5	14.5	62.6	27.5
63/25/63	16	801 01 632563		24	62.5	27.5	24.5	16	62.5	27.5
63/32/63	16	801 01 633263		24	62.5	27.5	31.5	18	62.5	27.5
63/40/63	16	801 01 634063		16	62.5	27.5	39.4	20.5	62.5	27.5
63/50/63	16	801 01 635063		16	62.5	27.5	49.4	23.5	62.5	27.5
75/20/75	16	801 01 752075		10	74.2	31	19.5	14.5	74.2	31
75/25/75	16	801 01 752575		10	74.2	31	24.5	16	74.2	31
75/32/75	16	801 01 753275		10	74.2	31	31.5	18	74.2	31
75/40/75	16	801 01 754075		10	74.2	31	39.4	20.5	74.2	31
75/50/75	16	801 01 755075		10	74.2	31	49.4	23.5	74.2	31
75/63/75	16	801 01 756375		10	74.2	31	62.5	27.5	74.2	31
90/25/90	16	801 01 902590		5	89.2	35.5	24.5	16	89.2	35.5
90/32/90	16	801 01 903290		5	89.2	35.5	31.5	18	89.2	35.5
90/40/90	16	801 01 904090		5	89.2	35.5	39.4	20.5	89.2	35.5
90/50/90	16	801 01 905090		5	89.2	35.5	49.4	23.5	89.2	35.5
90/63/90	16	801 01 906390		5	89.2	35.5	62.5	27.5	89.2	35.5
90/75/90	16	801 01 907590		5	89.2	35.5	74.2	31	89.2	35.5
110/32/110	16	801 01 11032110		2	109	41.5	31.5	18	109	41.5
110/40/110	16	801 01 11040110		2	109	41.5	39.4	20.5	109	41.5
110/50/110	16	801 01 11050110		2	109	41.5	49.4	23.5	109	41.5
110/63/110	16	801 01 11063110		2	109	41.5	62.5	27.5	109	41.5
110/75/110	16	801 01 11075110		2	109	41.5	74.2	31	109	41.5
110/90/110	16	801 01 11090110		2	109	41.5	89.2	35.5	109	41.5
125/110/125	16	801 01 125110125		2	123.9	46.5	109	41.5	123.9	46.5

PP-R Radyatör Baypas
PP-R Radiator Bypass

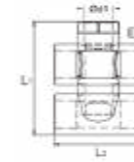

Çap Dia	Basınç Pn	Kod Code	Fiyat (Adet) Price (Pcs)	Koli/Adet Box/Pcs	d1	E	L1	L2
20/20	16	810 03 2020 2		100	19.5	14.5	78.3	60
25/25	16	810 03 2525 2		60	24.5	16	93	70

PP-R İstavroz
PP-R Cross

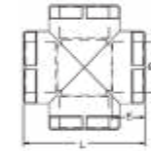

Çap Dia	Basınç Pn	Kod Code	Fiyat (Adet) Price (Pcs)	Koli/Adet Box/Pcs	d1	E	L
20	16	801 02 020 2		200	19.5	14.5	50
25	16	801 02 025 2		125	24.5	16	55
32	16	801 02 032 2		60	31.5	18	60
40	16	801 02 040 2		40	39.4	20.5	86

PP-R İnegal İstavroz
PP-R Reducer Cross

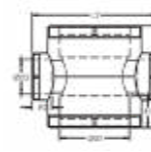

Çap Dia	Basınç Pn	Kod Code	Fiyat (Adet) Price (Pcs)	Koli/Adet Box/Pcs	d1	d2	E1	E2	L1	L2
25/20	16	810 01 2520 2		150	24.5	19.5	16.0	14.5	56	56
32/25	16	810 01 3225 2		75	31.5	24.5	18	16.0	70	70
40/32	16	810 01 4032 2		40	39.4	31.5	20.5	18	86	86
50/20	16	810 01 5020 2		30	49.4	119.5	23.5	14.5	84	95
50/25	16	810 01 5025 2		30	49.4	24.5	23.5	16	84	95
50/32	16	810 01 5032 2		25	49.4	31.5	23.5	18	114	95
50/40	16	810 01 5040 2		25	49.4	39.5	23.5	20.5	114	95
63/20	16	810 01 6320 2		16	62.5	19.5	27.5	14.5	91	111
63/25	16	810 01 6325 2		16	62.5	24.5	27.5	16	91	111
63/32	16	810 01 6332 2		16	62.5	31.5	27.5	18	127	113
63/40	16	810 01 6340 2		16	62.5	39.4	27.5	20.5	127	113
63/50	16	810 01 6350 2		12	62.5	49.4	27.5	23.5	127	113

PP-R Köşe İstavroz
PP-R Corner Cross

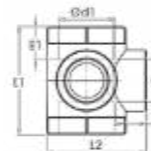

Çap Dia	Basınç Pn	Kod Code	Fiyat (Adet) Price (Pcs)	Koli/Adet Box/Pcs	d1	d2	E1	E2	L1	L2
32/20	16	810 02 3220 2		80	31.5	19.5	18	14.5	62	57
32/25	16	810 02 3225 2		80	31.5	24.5	18	16	62	57
40/20	16	810 02 4020 2		60	39.4	19.5	20.5	14.5	66	60
40/25	16	810 02 4025 2		60	39.4	24.5	20.5	16	66	60

PP-R Kapama Başlığı
PP-R Stopend

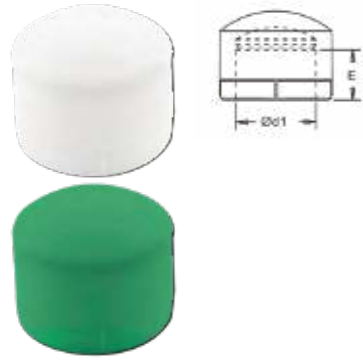

Çap Dia	Basınç Pn	Kod Code	Fiyat (Adet) Price (Pcs)	Koli/Adet Box/Pcs	d1	E
20	16	802 20 020 2		750	19.5	14.5
25	16	802 20 025 2		500	24.5	16
32	16	802 20 032 2		250	31.5	18
40	16	802 20 040 2		150	39.5	20.5
50	16	802 20 050 2		80	49.4	23.5
63	16	802 20 063 2		50	62.5	27.5
75	16	802 20 075 2		25	74.2	31
90	16	802 20 090 2		18	89.2	35.5
110	16	802 20 110 2		9	109	41.5
125	16	802 20 125 2		6	123.9	46.5

PP-R Flanş Adaptörü
PP-R Flange Adaptor

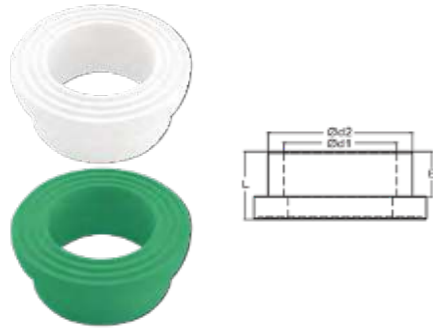

Çap Dia	Basınç Pn	Kod Code	Fiyat (Adet) Price (Pcs)	Koli/Adet Box/Pcs	d1	d2	E	L
50	16	810 04 050 2		80	49.4	65	23.5	32
63	16	810 04 063 2		50	62.5	80	27.5	40
75	16	810 04 075 2		40	74.2	95	31	40
90	16	810 04 090 2		25	89.2	111	35.5	42
110	16	810 04 110 2		12	109	132	41.5	49

PP-R Flanş
PP-R Flange

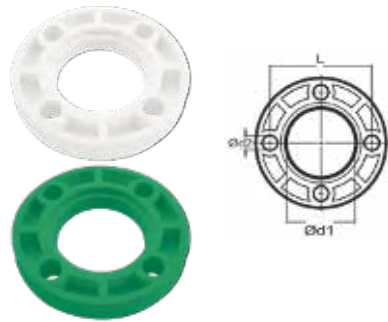

Çap Dia	Basınç Pn	Kod Code	Fiyat (Adet) Price (Pcs)	Koli/Adet Box/Pcs	d1	d2	E	L
50	16	810 05 050 2		80	66	17	109	30
63	16	810 05 063 2		50	81	17	121	30
75	16	810 05 075 2		40	97	17	144	16
90	16	810 05 090 2		25	113	17	160	16
110	16	810 05 110 2		12	133	17	180	12

PP-R Uzun Körtapa
PP-R End Plug-Long



Çap Dia	Basınç Pn	Kod Code	Fiyat (Adet) Price (Pcs)	Koli/Adet Box/Pcs	d	L	E
20x1/2"	16	810 06 020 2		750	20.3	56	5

PP-R Körtapa
PP-R End Plug



Çap Dia	Basınç Pn	Kod Code	Fiyat (Adet) Price (Pcs)	Koli/Adet Box/Pcs	D	L
20x1/2"	16	810 07 020 2		2500	20.3	25
25x3/4"	16	810 07 025 2		2500	26	15

Cetvel Ruler

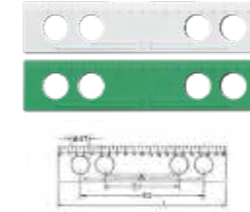

Çap Dia	Basınç Pn	Kod Code	Fiyat (Adet) Price (Pcs)	Koli/Adet Box/Pcs	d1	E1	E2	L
1/2"	16	810 08 020 2		400	20.5	90	150	200

PP-R Erkek İstavroz
PP-R Male Cross

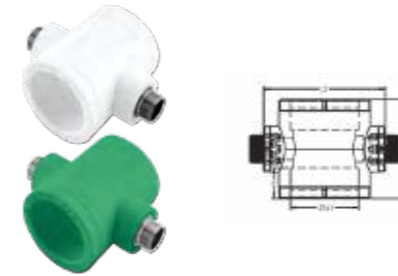

Çap Dia	Basınç Pn	Kod Code	Fiyat (Adet) Price (Pcs)	Koli/Adet Box/Pcs	d1	E	L1	L2
50x1/2"	16	810 09 5020 2		16	49.4	23.5	84	95
50x3/4"	16	810 09 5025 2		16	49.4	23.5	84	95
50x1"	16	810 09 5032 2		16	49.4	23.5	114	95
50x1 1/4"	16	810 09 5040 2		12	49.4	23.5	114	95
63x1/2"	16	810 09 6320 2		8	62.5	27.5	91	111
63x3/4"	16	810 09 6325 2		8	62.5	27.5	91	111
63x1"	16	810 09 6332 2		8	62.5	27.5	127	113
63x1 1/4"	16	810 09 6340 2		6	62.5	27.5	127	120

PP-R Dişi İstavroz
PP-R Female Cross

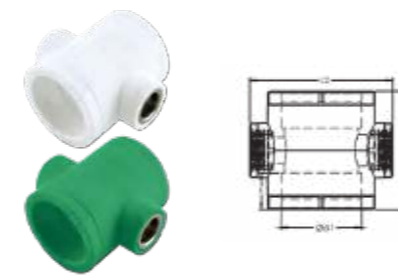

Çap Dia	Basınç Pn	Kod Code	Fiyat (Adet) Price (Pcs)	Koli/Adet Box/Pcs	d1	E	L1	L2
25x1/2"	16	811 00 2520 2		80	24.5	16	56	56
32x3/4"	16	811 00 3225 2		40	31.5	18	70	70
40x3/4"	16	811 00 4025 2		20	39.5	20.5	86	86
40x1"	16	811 00 4032 2		20	39.5	20.5	86	86
50x1/2"	16	811 00 5020 2		16	49.4	23.5	84	95
50x3/4"	16	811 00 5025 2		16	49.4	23.5	84	95
50x1"	16	811 00 5032 2		16	49.4	23.5	114	95
50x1 1/4"	16	811 00 5040 2		12	49.4	23.5	114	95
63x1/2"	16	811 00 6320 2		8	62.5	27.5	91	111
63x3/4"	16	811 00 6325 2		8	62.5	27.5	91	111
63x1"	16	811 00 6332 2		8	62.5	27.5	127	113
63x1 1/4"	16	811 00 6340 2		6	62.5	27.5	127	120

PP-R Plastik Branşman
PP-R Saddle

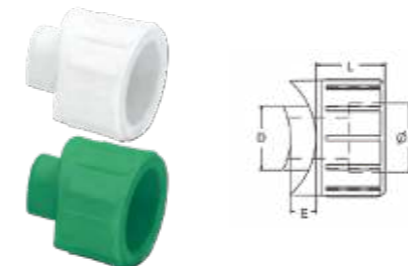

Çap Dia	Basınç Pn	Kod Code	Fiyat (Adet) Price (Pcs)	Koli/Adet Box/Pcs	d1	E	D	L
20	16	811 01 020 2		300	19.5	14.5	20.3	22
25	16	811 01 025 2		200	24.5	16	25.3	25
32	16	811 01 032 2		100	31.5	18	32.3	30

PP-R Erkek Branşman
PP-R Saddle Male

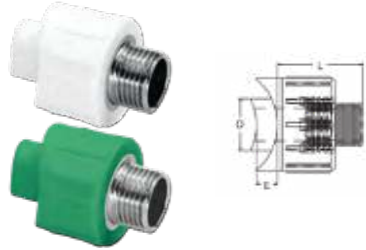

Çap Dia	Basınç Pn	Kod Code	Fiyat (Adet) Price (Pcs)	Koli/Adet Box/Pcs	D	E	L
20x1/2"	16	811 02 020 2		150	20.3	14.5	40
25x3/4"	16	811 02 025 2		100	25.3	16	42
32x1"	16	811 02 032 2		50	32.3	18	44

PP-R Dişi Branşman
PP-R Saddle Female

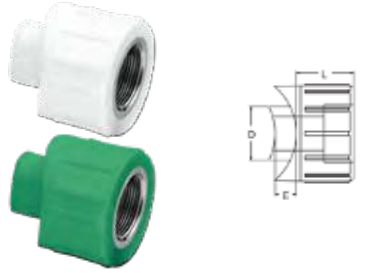

Çap Dia	Basınç Pn	Kod Code	Fiyat (Adet) Price (Pcs)	Koli/Adet Box/Pcs	D	E	L
20x1/2"	16	811 03 020 2		150	20.3	14.5	22
25x3/4"	16	811 03 025 2		100	25.3	16	25
32x1"	16	811 03 032 2		50	32.3	18	30

PP-R Erkek Nipel
PP-R Male Nipple

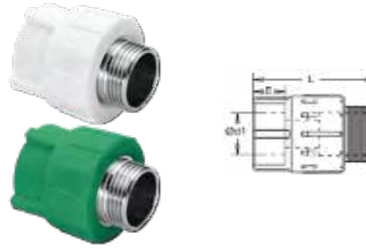

Çap Dia	Basınç Pn	Kod Code	Fiyat (Adet) Price (Pcs)	Koli/Adet Box/Pcs	d1	L	E
20x1/2"	16	811 04 2020 2		150	19.5	55	14.5
20x3/4"	16	811 04 2025 2		100	19.5	55	14.5
25x1/2"	16	811 04 2520 2		125	24.5	57	16
25x3/4"	16	811 04 2525 2		80	24.5	57	16
25x1"	16	811 04 2532 2		50	24.5	57	16
32x1/2"	16	811 04 3220 2		50	31.5	60	18
32x3/4"	16	811 04 3225 2		60	31.5	60	18
32x1"	16	811 04 3232 2		60	31.5	60	18

PP-R Altıköşe Erkek Nipel
PP-R Male Nipple Hexagonal

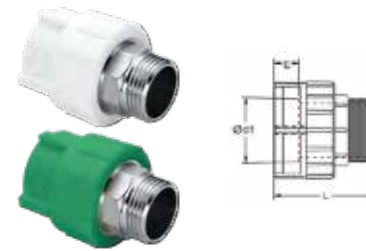

Çap Dia	Basınç Pn	Kod Code	Fiyat (Adet) Price (Pcs)	Koli/Adet Box/Pcs	d1	L	E
32 x 1"	16	811 05 3232 2		50	31.5	59	18
40 x 1"	16	811 05 4032 2		20	39.4	75	20.5
40 x 1 1/4"	16	811 05 4040 2		20	39.4	80	20.5
50 x 1 1/2"	16	811 05 5050 2		15	49.4	90	23.5
63 x 2"	16	811 05 6363 2		10	62.5	95	27.5
75 x 2 1/2"	16	811 05 7575 2		6	74.2	105	31
90 x 3"	16	811 05 9090 2		4	89.2	120	35.5
110 x 4"	16	811 05 0110 2		2	109	130	41.5
125 x 5"	16	811 05 0125 2		2	123.9	140	46.5

PP-R Dişi Nipel
PP-R Female Nipple

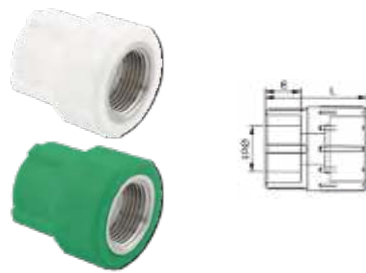

Çap Dia	Basınç Pn	Kod Code	Fiyat (Adet) Price (Pcs)	Koli/Adet Box/Pcs	d1	L	E
20 x 1/2"	16	811 06 2020 2		150	19.5	40	14.5
20 x 3/4"	16	811 06 2025 2		125	19.5	40	14.5
25 x 1/2"	16	811 06 2520 2		125	24.5	42	16
25 x 3/4"	16	811 06 2525 2		100	24.5	42	16
25 x 1"	16	811 06 2532 2		50	24.5	42	16
32 x 1/2"	16	811 06 3220 2		75	31.5	44	18
32 x 3/4"	16	811 06 3225 2		50	31.5	44	18
32 x 1"	16	811 06 3232 2		75	31.5	44	18

PP-R Altıköşe Dişi Nipel
PP-R Female Nipple Hexagonal

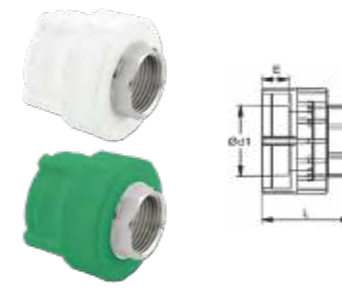

Çap Dia	Basınç Pn	Kod Code	Fiyat (Adet) Price (Pcs)	d1	L	E	Koli/Adet Box/Pcs
32 x 1"	16	811 07 3232 2		31.5	18	55	40
40 x 1"	16	811 07 4032 2		39.4	20.5	60	20
40 x 1 1/4"	16	811 07 4040 2		39.4	20.5	65	20
50 x 1 1/2"	16	811 07 5050 2		49.4	23.5	70	20
63 x 2"	16	811 07 6363 2		62.5	27.5	75	10
75 x 2 1/2"	16	811 07 7575 2		74.2	31	80	8
90 x 3"	16	811 07 9090 2		89.2	35.5	105	6
110 x 4"	16	811 07 0110 2		109	41.5	110	2
125 x 5"	16	811 07 0125 2		123.9	46.5	130	2

PP-R Erkek Dirsek
PP-R Male Elbow



Çap Dia	Basınç Pn	Kod Code	Fiyat (Adet) Price (Pcs)	Koli/Adet Box/Pcs	d1	L	E
20 x 1/2"	16	811 08 2020 2		100	19.5	35	14.5
20 x 3/4"	16	811 08 2025 2		75	19.5	35	14.5
25 x 1/2"	16	811 08 2520 2		100	24.5	40	16
25 x 3/4"	16	811 08 2525 2		75	24.5	40	16
32 x 1/2"	16	811 08 3220 2		30	31.5	45	18
32 x 3/4"	16	811 08 3225 2		30	31.5	45	18
32 x 1"	16	811 08 3232 2		30	31.5	45	18

PP-R Altıköşe Erkek Dirsek
PP-R Male Elbow Hexagonal

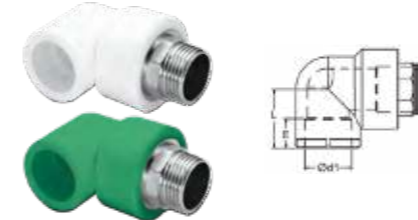

Çap Dia	Basınç Pn	Kod Code	Fiyat (Adet) Price (Pcs)	Koli/Adet Box/Pcs	d1	L	E
32 x 1"	16	811 09 3232 2		30	31.5	18	38.5
40 x 1 1/4"	16	811 09 4040 2		20	39.4	20.5	48.5
50 x 1 1/2"	16	811 09 5050 2		10	49.4	23.5	59
63 x 2"	16	811 09 6363 2		6	62.5	27.5	76.5

PP-R Dişi Dirsek
PP-R Female Elbow



Çap Dia	Basınç Pn	Kod Code	Fiyat (Adet) Price (Pcs)	Koli/Adet Box/Pcs	d1	L	E
20 x 1/2"	16	812 00 2020 2		125	19.5	35	14.5
20 x 3/4"	16	812 00 2025 2		80	19.5	35	14.5
25 x 1/2"	16	812 00 2520 2		125	24.5	40	16
25 x 3/4"	16	812 00 2525 2		80	24.5	40	16
32 x 1/2"	16	812 00 3220 2		30	31.5	45	18
32 x 3/4"	16	812 00 3225 2		30	31.5	45	18
32 x 1"	16	812 00 3232 2		30	31.5	45	18

PP-R Altıköşe Dişi Dirsek
PP-R Female Elbow Hexagonal



Çap Dia	Basınç Pn	Kod Code	Fiyat (Adet) Price (Pcs)	Koli/Adet Box/Pcs	d1	L	E
32 x 1"	16	812 01 3232 2		30	31.5	38.5	18
40 x 1 1/4"	16	812 01 4040 2		20	39.4	48.5	20.5
50 x 1 1/2"	16	812 01 5050 2		12	49.4	59	23.5
63 x 2"	16	812 01 6363 2		8	62.5	76.5	27.5

PP-R Erkek Batarya - 3 Ayak

PP-R Male Battery - Triple Connection



Çap Dia	Basınç Pn	Kod Code	Fiyat (Adet) Price (Pcs)	Koli/Adet Box/Pcs	d1	L	E
32 x 1"	16	812 02 3232 2		30	31.5	38.5	18
40 x 1 1/4"	16	812 02 4040 2		20	39.4	48.5	20.5
50 x 1 1/2"	16	812 02 5050 2		12	49.4	59	23.5
63 x 2"	16	812 02 6363 2		8	62.5	76.5	27.5

PP-R Dişi Batarya - 3 Ayak

PP-R Female Battery - Triple Connection



Çap Dia	Basınç Pn	Kod Code	Fiyat (Adet) Price (Pcs)	Koli/Adet Box/Pcs	d1	L	E
20 x 1/2"	16	812 03 2020 2		75	19.5	30	14.5
25 x 1/2"	16	812 03 2520 2		60	24.5	33	16

PP-R Dişi Batarya - 2 Ayak

PP-R Female Battery



Çap Dia	Basınç Pn	Kod Code	Fiyat (Adet) Price (Pcs)	Koli/Adet Box/Pcs	d1	L	E
25 x 3/4"	16	812 04 2525 2		60	24.5	40	16

PP-R Askılı Batarya

PP-R Female Battery Bypass



Çap Dia	Basınç Pn	Kod Code	Fiyat (Adet) Price (Pcs)	Koli/Adet Box/Pcs	d1	L	E
25 x 3/4"	16	812 05 2525 2		60	24.5	40	16

PP-R Erkek Çiftli Batarya Bağlantısı

PP-R Male Double Battery Connection

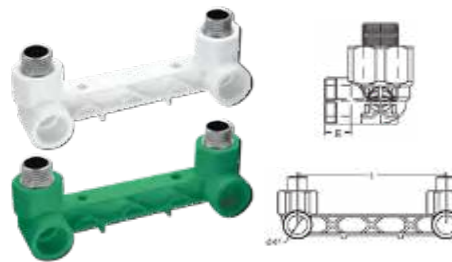

Çap Dia	Basınç Pn	Kod Code	Fiyat (Adet) Price (Pcs)	Koli/Adet Box/Pcs	d1	L	E
20 x 1/2"	16	812 06 2020 2		20	19.5	150	14.5
20 x 3/4"	16	812 06 2025 2		20	19.5	150	14.5
25 x 1/2"	16	812 06 2520 2		20	24.5	150	16
25 x 3/4"	16	812 06 2525 2		20	24.5	150	16

PP-R Dişi Çiftli Batarya Bağlantısı

PP-R Female Double Battery Connection

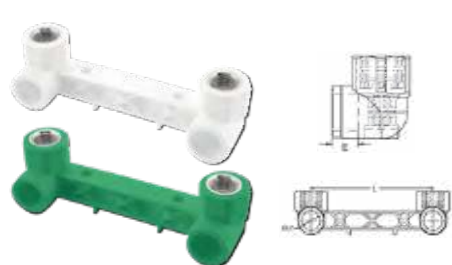

Çap Dia	Basınç Pn	Kod Code	Fiyat (Adet) Price (Pcs)	Koli/Adet Box/Pcs	d1	L	E
20 x 1/2"	16	803 80 020 2		25	19.5	150	14.5
25 x 1/2"	16	803 80 025 2		20	24.5	150	16

PP-R Erkek Çiftli Batarya Bağlantısı - Levha Tip

PP-R Male Double Battery Connection - Slab



Çap Dia	Basınç Pn	Kod Code	Fiyat (Adet) Price (Pcs)	Koli/Adet Box/Pcs	d1	L	E
20 x 1/2"	16	812 07 2020 2		20	19.5	150	14.5
20 x 3/4"	16	812 07 2025 2		20	19.5	150	14.5
25 x 1/2"	16	812 07 2520 2		20	24.5	150	16
25 x 3/4"	16	812 07 2525 2		20	24.5	150	16

PP-R Dişi Çiftli Batarya Bağlantısı - Levha Tip

PP-R Female Double Battery Connection - Slab

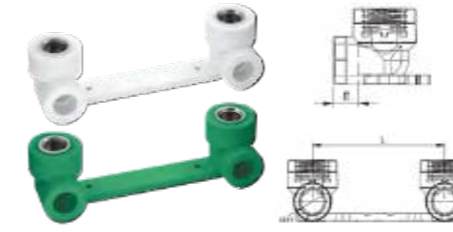

Çap Dia	Basınç Pn	Kod Code	Fiyat (Adet) Price (Pcs)	Koli/Adet Box/Pcs	d1	L	E
20 x 1/2"	16	812 08 2020 2		25	19.5	150	14.5
20 x 3/4"	16	812 08 2025 2		25	19.5	150	14.5
25 x 1/2"	16	812 08 2520 2		20	24.5	150	16
25 x 3/4"	16	812 08 2525 2		20	24.5	150	16

PP-R Ayarlı Batarya

PP-R Adjustable Battery



Çap Dia	Basınç Pn	Kod Code	Fiyat (Adet) Price (Pcs)	Koli/Adet Box/Pcs	d1	L1	L2	L3	E
20 x 1/2"	16	803 70 020 2		15	19.5	105	135	150	14.5
25 x 1/2"	16	803 70 025 2		15	24.5	105	135	150	16

PP-R Erkek Taharet Bağlantısı - Çift Giriş

PP-R Male Bidet Battery - Dual

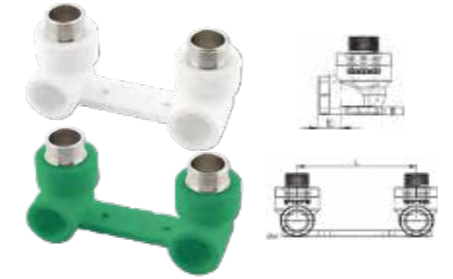

Çap Dia	Basınç Pn	Kod Code	Fiyat (Adet) Price (Pcs)	Koli/Adet Box/Pcs	d1	L	E
20 x 1/2"	16	812 09 2020 2		30	19.5	100	14.5
20 x 3/4"	16	812 09 2025 2		30	19.5	100	14.5
25 x 1/2"	16	812 09 2520 2		25	24.5	100	16
25 x 3/4"	16	812 09 2525 2		25	24.5	100	16

PP-R Dişi Taharet Bağlantısı - Çift Giriş

PP-R Female Bidet Battery - Dual



Çap Dia	Basınç Pn	Kod Code	Fiyat (Adet) Price (Pcs)	Koli/Adet Box/Pcs	d1	L	E
20 x 1/2"	16	803 80 020 2		30	19.5	100	14.5
25 x 1/2"	16	803 80 025 2		25	24.5	100	16
25 x 3/4"	16	803 81 025 2		25	24.5	100	16

PP-R Erkek Taharet Bağlantısı
PP-R Male Bidet Battery

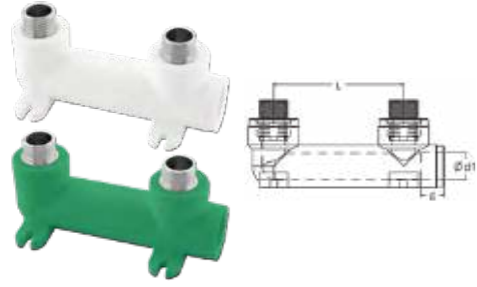

Çap Dia	Basınç Pn	Kod Code	Fiyat (Adet) Price (Pcs)	Koli/Adet Box/Pcs	d1	L	E
20 x 1/2"	16	803 60 020 2		30	19.5	90	14.5
25 x 1/2"	16	803 60 025 2		25	24.5	90	16

PP-R Dişi Taharet Bağlantısı
PP-R Female Bidet Battery

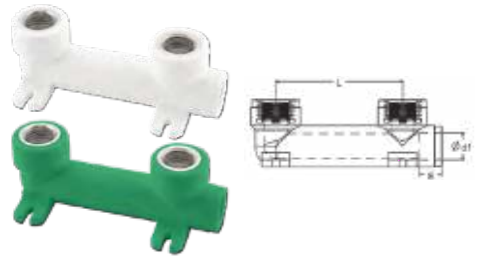

Çap Dia	Basınç Pn	Kod Code	Fiyat (Adet) Price (Pcs)	Koli/Adet Box/Pcs	d1	L	E
20 x 1/2"	16	802 80 020 2		35	19.5	90	14.5
25 x 1/2"	16	802 80 025 2		25	24.5	90	16

PP-R Erkek Te
PP-R Male Tee

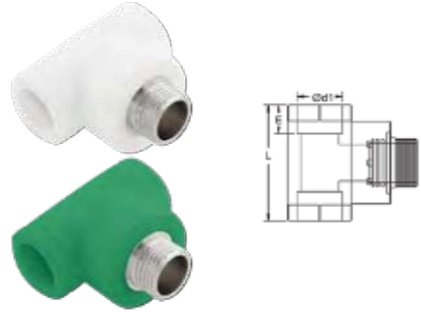

Çap Dia	Basınç Pn	Kod Code	Fiyat (Adet) Price (Pcs)	Koli/Adet Box/Pcs	d1	L	E
20 x 1/2"	16	813 00 2020 2		100	19.5	52	14.5
20 x 3/4"	16	813 00 2025 2		75	19.5	52	14.5
25 x 1/2"	16	813 00 2520 2		75	24.5	59	16
25 x 3/4"	16	813 00 2525 2		50	24.5	59	16
32 x 1/2"	16	813 00 3220 2		30	31.5	70	18
32 x 3/4"	16	813 00 3225 2		30	31.5	44	18
32 x 1"	16	813 00 3232 2		30	31.5	44	18
40 x 1/2"	16	813 00 4020 2		20	39.4	77	20.5
40 x 3/4"	16	813 00 4025 2		20	39.4	77	20.5
40 x 1"	16	813 00 4032 2		20	39.4	82	20.5
50 x 1/2"	16	813 00 5020 2		15	49.4	87	23.5
50 x 3/4"	16	813 00 5025 2		15	49.4	87	23.5
50 x 1"	16	813 00 5032 2		15	49.4	102	23.5
63 x 1/2"	16	813 00 6320 2		8	62.5	120	27.5
63 x 3/4"	16	813 00 6325 2		8	62.5	120	27.5
63 x 1"	16	813 00 6332 2		8	62.5	120	27.5

PP-R Altıköşe Erkek Te
PP-R Male Tee Hexagonal

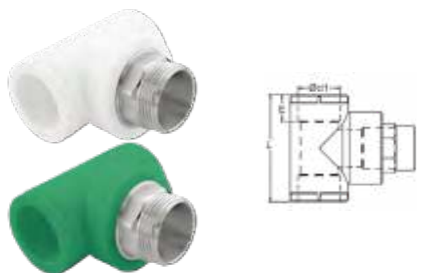

Çap Dia	Basınç Pn	Kod Code	Fiyat (Adet) Price (Pcs)	Koli/Adet Box/Pcs	d1	L	E
32 x 1"	16	813 01 3232 2		30	31.5	70	18
40 x 1 1/4"	16	813 01 4040 2		15	39.4	97.5	20.5

PP-R Dişi Te
PP-R Female Tee



Çap Dia	Basınç Pn	Kod Code	Fiyat (Adet) Price (Pcs)	Koli/Adet Box/Pcs	d1	L	E
20 x 1/2"	16	813 02 2020 2		100	19.5	60	14.5
20 x 3/4"	16	813 02 2025 2		75	19.5	60	14.5
25 x 1/2"	16	813 02 2520 2		75	24.5	52	16
25 x 3/4"	16	813 02 2525 2		50	24.5	66	16
32 x 1/2"	16	813 02 3220 2		30	31.5	80	18
32 x 3/4"	16	813 02 3225 2		30	31.5	80	18
32 x 1"	16	813 02 3232 2		30	31.5	80	18
40 x 1/2"	16	813 02 4020 2		20	39.4	77	20.5
40 x 3/4"	16	813 02 4025 2		20	39.4	77	20.5
40 x 1"	16	813 02 4032 2		20	39.4	82	20.5
50 x 1/2"	16	813 02 5020 2		15	49.4	87	23.5
50 x 3/4"	16	813 02 5025 2		15	49.4	87	23.5
50 x 1"	16	813 02 5032 2		15	49.4	102	23.5
63 x 1/2"	16	813 02 6320 2		9	62.5	120	27.5
63 x 3/4"	16	813 02 6325 2		9	62.5	120	27.5
63 x 1"	16	813 02 6332 2		9	62.5	120	27.5

PP-R Altıköşe Dişi Te
PP-R Female Tee Hexagonal

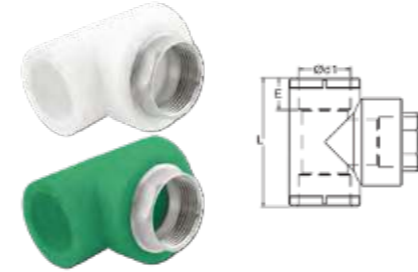

Çap Dia	Basınç Pn	Kod Code	Fiyat (Adet) Price (Pcs)	Koli/Adet Box/Pcs	d1	L	E
32 x 1"	16	813 03 3232 2		30	31.5	80	18
40 x 1 1/4"	16	813 03 4040 2		20	39.4	97.5	20.5

PP-R Plastik Küresel Vana
PP-R Ball Valve



Çap Dia	Basınç Pn	Kod Code	Fiyat (Adet) Price (Pcs)	Koli/Adet Box/Pcs	d1	L	E
20	16	804 00 020 2		50	19.5	66	14.5
25	16	804 00 025 2		40	24.5	73	16
32	16	804 00 032 2		20	31.5	88	18
40	16	804 00 040 2		12	39.4	105	20.5
50	16	804 00 050 2		8	49.4	125	23.5
63	16	804 00 063 2		4	62.5	150	27.5
75	16	804 00 075 2		4	74.2	165	31

PP-R Plastik Küresel Vana - Eko
PP-R Ball Valve - Eco

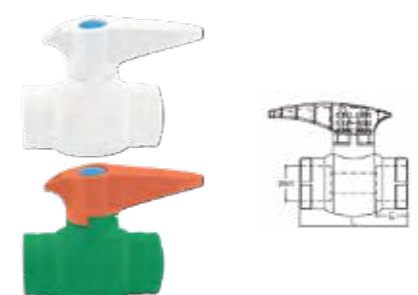

Çap Dia	Basınç Pn	Kod Code	Fiyat (Adet) Price (Pcs)	Koli/Adet Box/Pcs	d1	L	E
20	16	805 20 020 2		90	19.5	59	14.5
25	16	805 20 025 2		60	24.5	64	16
32	16	805 20 032 2		40	31.5	75	18

PP-R Plastik Küresel Vana - Kısa
PP-R Ball Valve (Short Handle)



Çap Dia	Basınç Pn	Kod Code	Fiyat (Adet) Price (Pcs)	Koli/Adet Box/Pcs	d1	L	E	L1
20	16	813 04 020 2		90	19.5	59	14.5	60
25	16	813 04 025 2		60	24.5	64	16	65
32	16	813 04 032 2		40	31.5	75	18	70

PP-R Küresel Vana - Sıva Altı
PP-R Undercoating Ball Valve



Çap Dia	Basınç Pn	Kod Code	Fiyat (Adet) Price (Pcs)	Koli/Adet Box/Pcs	d1	L	L1	E
20	16	813 05 020 2		24	19.5	70	98	14.5
25	16	813 05 025 2		20	24.5	75	102	16

PP-R Küresel Vana - Çift Taraflı
PP-R Ball Valve with Double Union



Çap Dia	Basınç Pn	Kod Code	Fiyat (Adet) Price (Pcs)	Koli/Adet Box/Pcs	d1	L	E
20	16	813 06 020 2		30	19.5	120	14.5
25	16	813 06 025 2		20	24.5	124	16
32	16	813 06 032 2		15	31.5	140	18

PP-R Dişi Küresel Vana - Tek Taraflı
PP-R Female Ball Valve with Single Union



Çap Dia	Basınç Pn	Kod Code	Fiyat (Adet) Price (Pcs)	Koli/Adet Box/Pcs	d1	L	E
20	16	813 07 020 2		30	19.5	91	14.5
25	16	813 07 025 2		25	24.5	95	16
32	16	813 07 032 2		20	31.5	109	18

PP-R Küresel Vana - Tek Taraflı
PP-R Ball Valve with Single Union

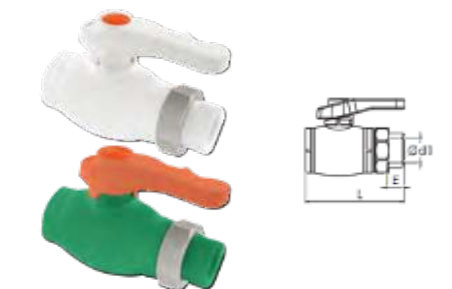

Çap Dia	Basınç Pn	Kod Code	Fiyat (Adet) Price (Pcs)	Koli/Adet Box/Pcs	d1	L	E
20	16	813 08 020 2		30	19.5	91	14.5
25	16	813 08 025 2		25	24.5	95	16
32	16	813 08 032 2		20	31.5	109	18

PP-R Dişi Küresel Vana
PP-R Female Ball Valve

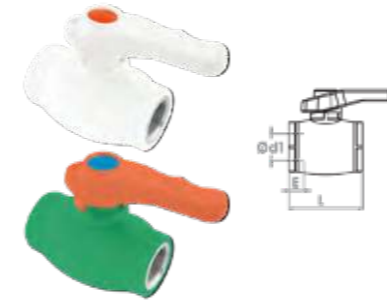

Çap Dia	Basınç Pn	Kod Code	Fiyat (Adet) Price (Pcs)	Koli/Adet Box/Pcs	d1	L	E
20 x 1/2"	16	813 09 020 2		50	19.5	64	14.5
25 x 3/4"	16	813 09 025 2		40	24.5	67	16
32 x 1"	16	813 09 032 2		20	31.5	78	18

PP-R Kollektör Vanası
PP-R Collector Valve



Çap Dia	Basınç Pn	Kod Code	Fiyat (Adet) Price (Pcs)	Koli/Adet Box/Pcs	d1	L	E
25 x 1"	16	814 00 025 2		25	24.5	106	16
32 x 1"	16	814 00 032 2		25	31.5	110	18

PP-R Radyatör Vanası - Düz
PP-R Radiator Valve Straight



Çap Dia	Basınç Pn	Kod Code	Fiyat (Adet) Price (Pcs)	Koli/Adet Box/Pcs	d1	L1	L	E
20 x 1/2"	16	814 00 2020 2		50	19.5	67	89	14.5
25 x 1/2"	16	814 00 2520 2		50	24.5	67	89	16
25 x 3/4"	16	814 00 2525 2		40	24.5	72	94	16

PP-R Radyatör Vanası - Dirsekli
PP-R Radiator Valve Elbow



Çap Dia	Basınç Pn	Kod Code	Fiyat (Adet) Price (Pcs)	Koli/Adet Box/Pcs	d1	L1	L	E
20 x 1/2"	16	814 01 2020 2		50	19.5	83	87,5	14.5
25 x 1/2"	16	814 01 2520 2		50	24.5	83	87,5	16
25 x 3/4"	16	814 01 2525 2		40	24.5	90,5	91	16

PP-R Oynar Başlı Radyatör Nipeli
PP-R Radiator Adaptor

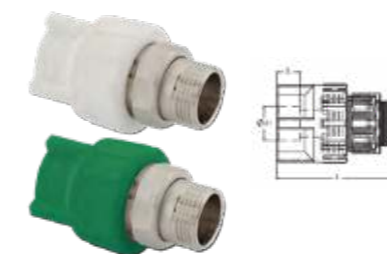

Çap Dia	Basınç Pn	Kod Code	Fiyat (Adet) Price (Pcs)	Koli/Adet Box/Pcs	d1	L	E
20 x 1/2"	16	814 02 2020 2		60	19.5	55	14.5
20 x 3/4"	16	814 02 2025 2		50	19.5	57	14.5
25 x 1/2"	16	814 02 2520 2		60	24.5	57	16
25 x 3/4"	16	814 02 2525 2		50	24.5	57	16

PP-R Oynar Başlı Radyatör Dirseği
PP-R Radiator Elbow Adaptor

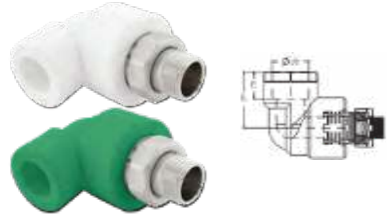

Çap Dia	Basınç Pn	Kod Code	Fiyat (Adet) Price (Pcs)	Koli/Adet Box/Pcs	d1	L	E
20 x 1/2"	16	814 03 2020 2		60	19.5	30	14.5
20 x 3/4"	16	814 03 2025 2		50	19.5	35	14.5
25 x 1/2"	16	814 03 2520 2		60	24.5	40	16
25 x 3/4"	16	814 03 2525 2		50	24.5	40	16

PP-R Kelebek Vana
PP-R Stop Valve



Çap Dia	Basınç Pn	Kod Code	Fiyat (Adet) Price (Pcs)	Koli/Adet Box/Pcs	d1	L	L1	E
20	16	804 90 020 2		40	19.5	73	96	14.5
25	16	804 90 025 2		30	24.5	73	105	16
32	16	804 90 032 2		20	31.5	86	109	18
40	16	804 90 040 2		15	39.4	93	129	20.5

PP-R Lüx Stop Vana
PP-R Lustration Valve



Çap Dia	Basınç Pn	Kod Code	Fiyat (Adet) Price (Pcs)	Koli/Adet Box/Pcs	d1	E	L	L1
20	25	814 04 020 2		15	19.5	14.5	73	138
25	25	814 04 025 2		15	24.5	16	78	138
32	25	814 04 032 2		15	31.5	18	87	143

PP-R Kromlu Ankastr Vana
PP-R Chrome Valve - Plastic Encastre



Çap Dia	Basınç Pn	Kod Code	Fiyat (Adet) Price (Pcs)	Koli/Adet Box/Pcs	d1	L	L1	E
20	25	804 30 020 2		30	19.5	73	93	14.5
25	25	804 30 025 2		25	24.5	73	94	16
32	25	804 30 032 2		25	31.5	86	105	18
40	25	804 30 040 2		20	39.4	93	107	20,5

PP-R Kromlu Vana
PP-R Chrome Valve - Plastic Head



Çap Dia	Basınç Pn	Kod Code	Fiyat (Adet) Price (Pcs)	Koli/Adet Box/Pcs	d1	L	L1	E
20	25	804 20 020 2		25	19.5	73	138	14.5
25	25	804 20 025 2		20	24.5	73	141	16
32	25	804 20 032 2		15	31.5	86	151	18
40	25	804 20 040 2		10	39,4	93	157	20,5

PP-R Kromlu Vana - Mevlana
PP-R Chrome Valve Triangle - Plastic Head



Çap Dia	Basınç Pn	Kod Code	Fiyat (Adet) Price (Pcs)	Koli/Adet Box/Pcs	d1	L	L1	E
20	25	804 10 020 2		25	19.5	73	131	14.5
25	25	804 10 025 2		20	24.5	73	137	16
32	25	804 10 032 2		15	31.5	86	147	18
40	25	804 10 040 2		10	39,4	93	153	20,5

PP-R Kromlu Küresel Vana
PP-R Chrome Ball Valve - Plastic Head



Çap Dia	Basınç Pn	Kod Code	Fiyat (Adet) Price (Pcs)	Koli/Adet Box/Pcs	d1	L	L1	E
20	25	814 05 020 2		25	19.5	67	132	14.5
25	25	814 05 025 2		20	24.5	74	138	16
32	25	814 05 032 2		15	31.5	87	150	18

PP-R Kromlu Küresel Vana - Mevlana
PP-R Chrome Ball Valve Triangle - Plastic Head



Çap Dia	Basınç Pn	Kod Code	Fiyat (Adet) Price (Pcs)	Koli/Adet Box/Pcs	d1	L	L1	E
20	25	814 06 020 2		25	19.5	67	126	14.5
25	25	814 06 025 2		20	24.5	74	133	16
32	25	814 06 032 2		15	31.5	87	148	18

PP-R Bahçe Musluğu
PP-R Garden Tap



Çap Dia	Basınç Pn	Kod Code	Fiyat (Adet) Price (Pcs)	Koli/Adet Box/Pcs	d1	L	L1
1/2"	16	814 07 020 2		40	13.5	74	63

PP-R Çamaşır Makinesi Musluğu
PP-R Washing Machine Tap



Çap Dia	Basınç Pn	Kod Code	Fiyat (Adet) Price (Pcs)	Koli/Adet Box/Pcs	L	L1
1/2-3/4"	16	814 08 2025 2		40	72	39

PP-R Çiftli Musluk Çatalı
PP-R Twin Tap



Çap Dia	Basınç Pn	Kod Code	Fiyat (Adet) Price (Pcs)	Koli/Adet Box/Pcs
3/4"	16	814 09 025 2		100

PP-R Erkek Çekvalf
PP-R Non Return Valve Male



Çap Dia	Basınç Pn	Kod Code	Fiyat (Adet) Price (Pcs)	Koli/Adet Box/Pcs	d1	d2	L	E
20	25	815 00 020 2		75	19.5	20,3	67	14.5
25	25	815 00 025 2		50	24.5	25,3	71	16
32	25	815 00 032 2		25	31.5	32,3	100	18

PP-R Dişi Çekvalf
PP-R Non Return Valve Female



Çap Dia	Basınç Pn	Kod Code	Fiyat (Adet) Price (Pcs)	Koli/Adet Box/Pcs	d1	L	E
20	25	815 01 020 2		75	19.5	67	14.5
25	25	815 01 025 2		50	24.5	71	16
32	25	815 01 032 2		25	31.5	100	18

PP-R Erkek Vana
PP-R Valve Male



Çap Dia	Basınç Pn	Kod Code	Fiyat (Adet) Price (Pcs)	Koli/Adet Box/Pcs	d1	d2	L	E
20	25	815 02 020 2		30	19.5	20.3	78	14.5
25	25	815 02 025 2		30	24.5	25.3	88	16
32	25	815 02 032 2		15	31.5	32.3	106	18

PP-R Dişi Vana
PP-R Valve Female



Çap Dia	Basınç Pn	Kod Code	Fiyat (Adet) Price (Pcs)	Koli/Adet Box/Pcs	d1	L	E
20	25	815 03 020 2		30	19.5	78	14.5
25	25	815 03 025 2		30	24.5	88	16
32	25	815 03 032 2		15	31.5	106	18

PP-R Erkek Filtre
PP-R Male Filter



Çap Dia	Basınç Pn	Kod Code	Fiyat (Adet) Price (Pcs)	Koli/Adet Box/Pcs	d1	d2	L	E
20	25	815 04 020 2		75	20.3	19.5	78	14.5
25	25	815 04 025 2		50	25.3	24.5	88	16
32	25	815 04 032 2		25	32.3	31.5	106	18

PP-R Dişi Filtre
PP-R Female Filter



Çap Dia	Basınç Pn	Kod Code	Fiyat (Adet) Price (Pcs)	Koli/Adet Box/Pcs	d1	L	E
20	25	815 05 020 2		75	19.5	78	14.5
25	25	815 05 025 2		50	24.5	88	16
32	25	815 05 032 2		25	31.5	106	18

PP-R Kuyruklu Erkek Nipel
PP-R Tailed Male Nipple

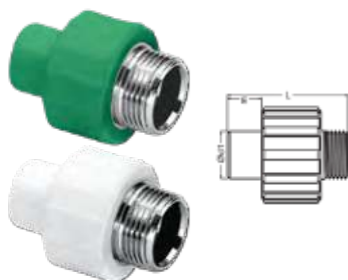

Çap Dia	Basınç Pn	Kod Code	Fiyat (Adet) Price (Pcs)	Koli/Adet Box/Pcs	d1	L	E
20 x 1/2"	25	815 06 2020 2		125	20.3	52	14.5
20 x 3/4"	25	815 06 2025 2		100	20.3	54	14.5
25 x 1/2"	25	815 06 2520 2		125	25.3	52	16
25 x 3/4"	25	815 06 2525 2		75	25.3	54	16

PP-R Kuyruklu Dişi Nipel
PP-R Tailed Female Nipple

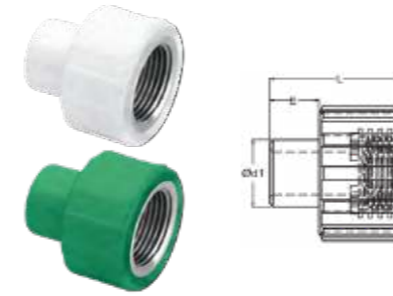

Çap Dia	Basınç Pn	Kod Code	Fiyat (Adet) Price (Pcs)	Koli/Adet Box/Pcs	d1	L	E
20 x 1/2"	25	815 07 2020 2		150	20.3	41	14.5
20 x 3/4"	25	815 07 2025 2		150	20.3	41	14.5
25 x 1/2"	25	815 07 2520 2		150	25.3	41	16
25 x 3/4"	25	815 07 2525 2		150	25.3	41	16

PP-R Hareketli Nipel
PP-R Nipple with Nut

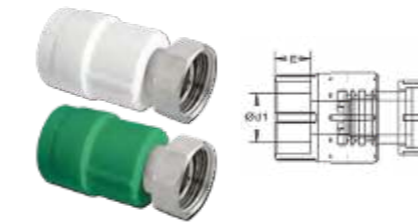

Çap Dia	Basınç Pn	Kod Code	Fiyat (Adet) Price (Pcs)	Koli/Adet Box/Pcs	d1	E
20 x 1/2"	25	815 08 2020 2		175	19.5	14.5
20 x 3/4"	25	815 08 2025 2		125	19.5	14.5
25 x 1/2"	25	815 08 2520 2		125	24.5	16
25 x 3/4"	25	815 08 2525 2		125	24.5	16
25 x 1"	25	815 08 2532 2		80	24.5	16
32 x 3/4"	25	815 08 3225 2		75	31.5	18
32 x 1"	25	815 08 3232 2		60	31.5	18
32 x 1" 1/4"	25	815 08 3240 2		50	31.5	18

PP-R Hareketli Dirsek
PP-R Elbow with Nut



Çap Dia	Basınç Pn	Kod Code	Fiyat (Adet) Price (Pcs)	Koli/Adet Box/Pcs	d1	L	E
20 x 1/2"	25	815 09 2020 2		120	19.5	30	14.5
20 x 3/4"	25	815 09 2025 2		80	19.5	30	14.5
25 x 3/4"	25	815 09 2525 2		80	24.5	32	16
25 x 1"	25	815 09 2532 2		75	24.5	32	16
32 x 3/4"	25	815 09 3225 2		50	31.5	38	18
32 x 1"	25	815 09 3232 2		50	31.5	38	18
32 x 1" 1/4"	25	815 09 3240 2		40	31.5	38	18

PP-R Hareketli Te
PP-R Tee with Nut



Çap Dia	Basınç Pn	Kod Code	Fiyat (Adet) Price (Pcs)	Koli/Adet Box/Pcs	d1	L	E
20 x 1/2"	25	816 00 2020 2		125	19.5	30	14.5
20 x 3/4"	25	816 00 2025 2		80	19.5	30	14.5
25 x 3/4"	25	816 00 2525 2		80	24.5	32	16
25 x 1"	25	816 00 2532 2		40	24.5	32	16
32 x 1"	25	816 00 3232 2		30	31.5	38	18
32 x 1" 1/4"	25	816 00 3240 2		30	31.5	38	18

PP-R PE-X Nipeli - Kuyruklu
PP-R PE-X Tail Adapter

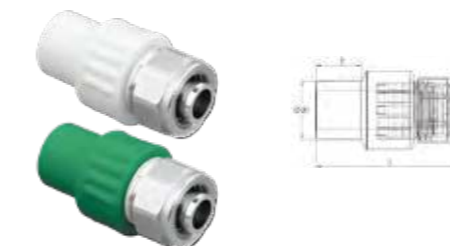

Çap Dia	Basınç Pn	Kod Code	Fiyat (Adet) Price (Pcs)	Koli/Adet Box/Pcs	d1	L	E
20x1/2"x16	25	816 01 2020 2		200	20.3	54	14.5

PP-R Oynar Başlı Erkek Rakor
PP-R Transition Union Male

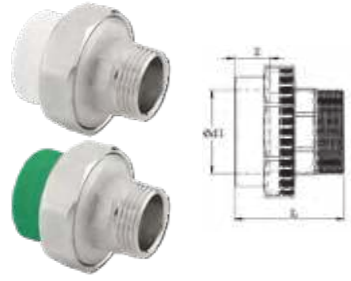

Çap Dia	Basınç Pn	Kod Code	Fiyat (Adet) Price (Pcs)	Koli/Adet Box/Pcs	d1	L	E
20 x 1/2"	25	816 02 2020 2		175	19.5	45	14.5
20 x 3/4"	25	816 02 2025 2		150	19.5	45	14.5
20 x 1"	25	816 02 2032 2		160	19.5	50	14.5
25 x 1/2"	25	816 02 2520 2		120	24.5	46	16
25 x 3/4"	25	816 02 2525 2		100	24.5	49	16
25 x 1"	25	816 02 2532 2		100	24.5	50	16
32 x 1/2"	25	816 02 3220 2		80	31.5	49	18
32 x 3/4"	25	816 02 3225 2		80	31.5	49	18
32 x 1"	25	816 02 3232 2		75	31.5	52	18
32 x 1 1/4"	25	816 02 4032 2		60	31.5	56	18
40 x 1 1/4"	25	816 02 4040 2		40	39.4	59	20.5
50 x 1 1/2"	25	816 02 5050 2		25	49.4	62	23.5
63 x 2"	25	816 02 6363 2		16	62.5	72	27.5
75 x 2 1/2"	25	816 02 7575 2		6	74.2	97	31
90 x 3"	25	816 02 9090 2		3	89.2	117	35.5
110 x 4"	25	816 02 0110 2		2	109	134	41.5

PP-R PE-X Nipel - Dişi
PP-R PE-X Female Adapter

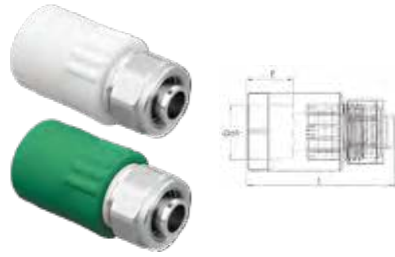

Çap Dia	Basınç Pn	Kod Code	Fiyat (Adet) Price (Pcs)	Koli/Adet Box/Pcs	d1	L	E
20x1/2"x16	25	816 03 2020 2		200	19.5	54	14.5

PP-R Oynar Başlı Dişi Rakor
PP-R Transition Union Female

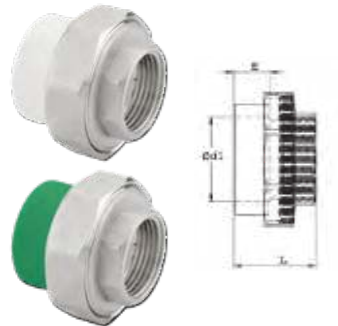

Çap Dia	Basınç Pn	Kod Code	Fiyat (Adet) Price (Pcs)	Koli/Adet Box/Pcs	d1	L	E
20 x 1/2"	25	816 04 2020 2		200	19.5	38	14.5
20 x 3/4"	25	816 04 2025 2		175	19.5	38	14.5
20 x 1"	25	816 04 2032 2		175	19.5	39	14.5
25 x 1/2"	25	816 04 2520 2		125	24.5	37	16
25 x 3/4"	25	816 04 2525 2		125	24.5	38	16
25 x 1"	25	816 04 2532 2		100	24.5	40	16
32 x 1/2"	25	816 04 3220 2		90	31.5	42	18
32 x 3/4"	25	816 04 3225 2		80	31.5	42	18
32 x 1"	25	816 04 3232 2		80	31.5	42	18
32 x 1 1/4"	25	816 04 4032 2		70	31.5	46	18
40 x 1 1/4"	25	816 04 4040 2		50	39.4	48	20.5
50 x 1 1/2"	25	816 04 5050 2		25	49.4	48	23.5
63 x 2"	25	816 04 6363 2		16	62.5	58	27.5
75 x 2 x 1/2"	25	816 04 7575 2		9	74.2	72	31
90 x 3"	25	816 04 9090 2		6	89.2	78	35.5
110 x 4"	25	816 04 0110 2		2	109	89	41.5

PP-R Hareketli Erkek Nipel - Hafif Tip
PP-R Transition Nipple Male

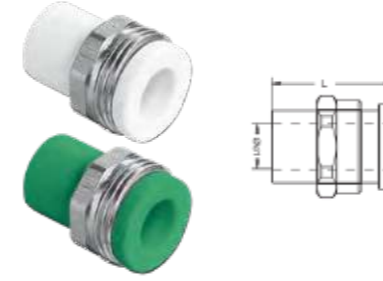

Çap Dia	Basınç Pn	Kod Code	Fiyat (Adet) Price (Pcs)	Koli/Adet Box/Pcs	d1	L
20 x 3/4"	25	816 05 2025 2		200	20.3	38
25 x 1"	25	816 05 2532 2		150	25.3	43

PP-R Hareketli Dişi Nipel - Hafif Tip
PP-R Transition Nipple Female

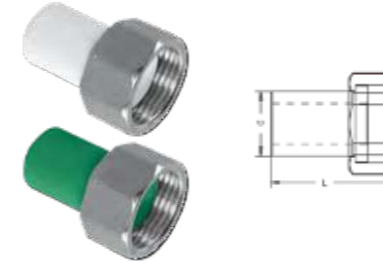

Çap Dia	Basınç Pn	Kod Code	Fiyat (Adet) Price (Pcs)	Koli/Adet Box/Pcs	d1	L
20 x 3/4"	25	816 06 2025 2		200	20.3	38
25 x 1"	25	816 06 2532 2		150	25.3	43

PP-R Su Sayaç Nipel
PP-R Water Meter Nipple

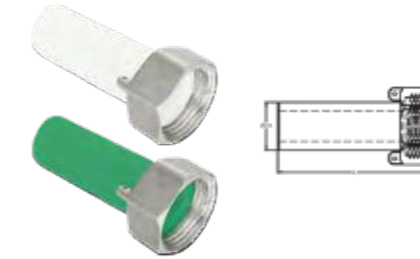

Çap Dia	Basınç Pn	Kod Code	Fiyat (Adet) Price (Pcs)	Koli/Adet Box/Pcs	d1	L
20 x 3/4"	25	816 07 2025 2		200	20.3	68
25 x 1"	25	816 07 2532 2		150	25.3	68

PP-R Çift Taraflı Kaynaklı Rakor
PP-R Transition Union Two Side Welded



Çap Dia	Basınç Pn	Kod Code	Fiyat (Adet) Price (Pcs)	Koli/Adet Box/Pcs	d1	L	E
20	25	816 08 020 2		100	19.5	14.5	56
25	25	816 08 025 2		75	24.5	16	59
32	25	816 08 032 2		50	31.5	18	60
40	25	816 08 040 2		30	39.4	20.5	59
50	25	816 08 050 2		25	49.4	23.5	59
63	25	816 08 063 2		14	62.5	27.5	72

PP-R Plastik Çift Taraflı Kaynaklı Rakor

PP-R Union

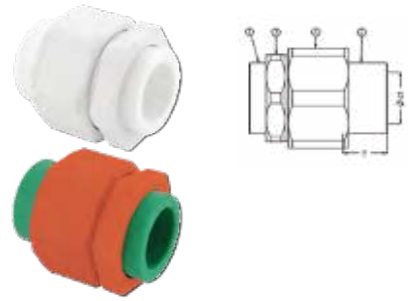

Çap Dia	Basınç Pn	Kod Code	Fiyat (Adet) Price (Pcs)	Koli/Adet Box/Pcs	d1	E
20	25	816 09 020 2		100	19.5	14.5
25	25	816 09 025 2		60	24.5	16
32	25	816 09 032 2		50	31.5	18

PP-R Plastik Çift Taraflı Kaynaklı Rakor PN 16

PP-R Union PN 16

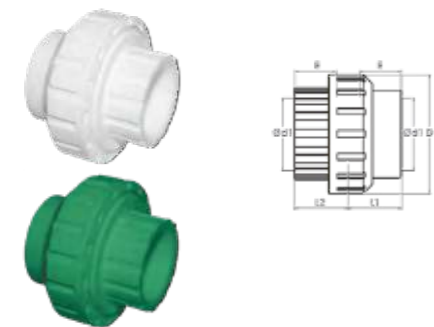

Çap Dia	Basınç Pn	Kod Code	Fiyat (Adet) Price (Pcs)	Koli/Adet Box/Pcs	d1	D	E	L1	L2
20	16	816 10 020 2		200	19.5	43	14.5	21.5	24.3
25	16	816 10 025 2		125	24.5	54	16	27.6	25.7
32	16	816 10 032 2		100	31.5	60	18	25.2	30.1
40	16	816 10 040 2		50	39.4	74	20.5	29	39
50	16	816 10 050 2		30	49.4	92	23.5	34	45
63	16	816 10 063 2		16	62.5	118	27.5	41	55
75	16	816 10 075 2		10	74.2	130	31	47	53
90	16	816 10 090 2		6	89.2	181	35.5	56	61
110	16	816 10 110 2		3	109	210	41.5	65	71

PP-R Plastik Oynar Başlı Erkek Rakor

PP-R Plastic Transition Union Male



Çap Dia	Basınç Pn	Kod Code	Fiyat (Adet) Price (Pcs)	Koli/Adet Box/Pcs	d1	L	E
20 x 1/2"	25	816 11 020 2		100	19.5	60	14.5
25 x 3/4"	25	816 11 025 2		70	24.5	65	16
32 x 1"	25	816 11 032 2		50	31.5	67	18

PP-R Plastik Oynar Başlı Dişi Rakor

PP-R Plastic Transition Union Female



Çap Dia	Basınç Pn	Kod Code	Fiyat (Adet) Price (Pcs)	Koli/Adet Box/Pcs	d1	L	E
20 x 1/2"	25	816 12 020 2		100	19.5	50	14.5
25 x 3/4"	25	816 12 025 2		80	24.5	55	16
32 x 1"	25	816 12 032 2		60	31.5	57	18

YEDEK PARÇALAR SPARE PARTS

ÜRETİM STANDARDI

PRODUCTION STANDARD

EN 1452-3



U-PVC Kelebek Vana Yedek Parça Listesi
U-PVC Butterfly Valve Spare List

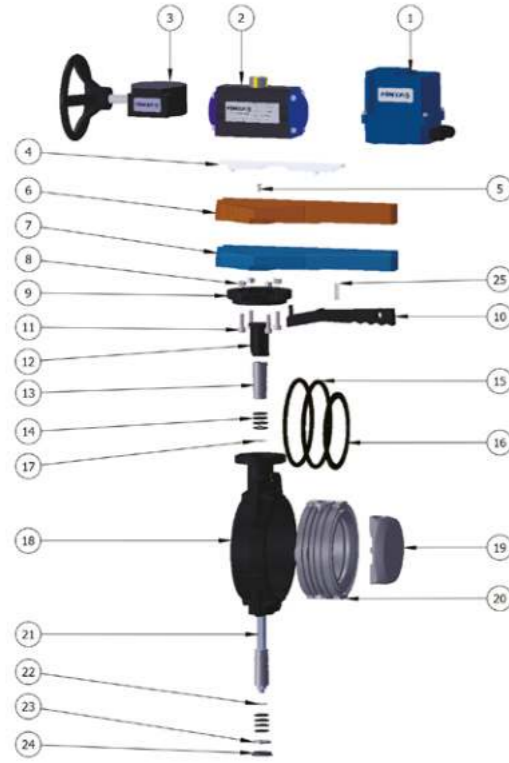

No	Parça Part	Malzeme Material	Adet QTY
1	Elektrikli Aktuatör		1
2	Pnomatik Aktuatör		1
3	Direksiyon		1
4	Kol Kapağı / Lever Clip	PVC	1
5	Civata / Screw	INOX	1
6	Kol / Handle (Su Vanası Kullanımı)	ABS	1
7	Kol / Handle (Asit Vanası Kullanımı)	ABS	1
8	Somun / Nut	INOX	4
9	Çark / Index Plate	PP GF	1
10	Mandal / Lever Catch	PP GF	1
11	Civata / Screw	INOX	4
12	Stop Parçası / End Stop	PP GF	1
13	Pim / Step	U-PVC / PP / C-PVC	1
14	Pim O-Ring / Step O-Ring	EPDM / FPM	8
15	İç Gövde Alın O-Ring	EPDM / FPM	2
16	İç Gövde O-Ring / Inner Seal	EPDM / FPM	1
17	Segman / Retaining Rings	INOX	1
18	Dış Gövde / Body	PP GF	1
19	Klape / Disc	U-PVC / PP / C-PVC	1
20	İç Gövde / Inner Body	U-PVC / PP / C-PVC	1
21	Şaft / Steel Shaft	STEEL	1
22	Segman / Retaining rings	INOX	1
23	Pul / Washer	INOX	1
24	Tapa / Cap	PP GF	1
25	Yay / Spring	INOX	1



No	Ø63 Kod /Code	Fiyat (Adet) Price (Pcs)	Ø75 Kod /Code	Fiyat (Adet) Price (Pcs)	Ø90 Kod /Code	Fiyat (Adet) Price (Pcs)	Ø110 Kod /Code	Fiyat (Adet) Price (Pcs)	Ø125-Ø140 Kod /Code	Fiyat (Adet) Price (Pcs)	
1	700006329	⌚	700007529	⌚	700009026	⌚	700009026	⌚	700011026	⌚	
2	700040027	⌚	700007527	⌚	700009027	⌚	700009027	⌚	700011027	⌚	
3	700040028	⌚	700007528	⌚	700009028	⌚	700009028	⌚	700011028	⌚	
4	202050902	⌚	202050902	⌚	202050902	⌚	202050902	⌚	202050902	⌚	
5	2021501409	⌚	2021501409	⌚	2021501409	⌚	2021501409	⌚	2021501409	⌚	
6	291139904	⌚	291139904	⌚	291139904	⌚	291139904	⌚	291131104	⌚	
7	291130905	⌚	29113905	⌚	29113905	⌚	29113905	⌚	291131105	⌚	
8	201151969	⌚	201151969	⌚	201151969	⌚	201151969	⌚	201151969	⌚	
9	400267952	⌚	400267952	⌚	400267952	⌚	400267952	⌚	400267952	⌚	
10	400267962	⌚	400267962	⌚	400267962	⌚	400267962	⌚	400261112	⌚	
11	201151979	⌚	201151979	⌚	201151979	⌚	201151979	⌚	201151979	⌚	
12	400267982	⌚	400267982	⌚	400267982	⌚	400267182	⌚	400267182	⌚	
13	201019995	⌚	201019995	⌚	201019995	⌚	201011115	⌚	201011115	⌚	
EPDM	14	201999999	⌚	201999999	⌚	201999999	⌚	201999998	⌚	201999998	⌚
FPM	14	201999900	⌚	201999900	⌚	201999900	⌚	201999990	⌚	201999990	⌚
EPDM	15	201030637	⌚	201030757	⌚	202030909	⌚	202031109	⌚	K00203779	⌚
FPM	15	201030639	⌚	201030758	⌚	205030909	⌚	406031109	⌚	K0023770	⌚
EPDM	16	201020639	⌚	201020759	⌚	201020909	⌚	201021109	⌚	201021409	⌚
FPM	16	201020630	⌚	201020750	⌚	201020900	⌚	201021100	⌚	201021400	⌚
17	102310209	⌚	102310209	⌚	102310209	⌚	102310209	⌚	102310209	⌚	
18	400267632	⌚	400267752	⌚	400267942	⌚	400110942	⌚	401251402	⌚	
19	201137634	⌚	201137754	⌚	201137974	⌚	201137104	⌚	201137105	⌚	
20	201010635	⌚	201010755	⌚	201010905	⌚	201011105	⌚	212514005	⌚	
21	201040634	⌚	201040754	⌚	201040904	⌚	201041104	⌚	201041254	⌚	
22	102310248	⌚	102310248	⌚	102310248	⌚	102310248	⌚	102310699	⌚	
23	102310259	⌚	102310259	⌚	102310259	⌚	102310259	⌚	102310259	⌚	
24	400267972	⌚	400267972	⌚	400267972	⌚	400267172	⌚	400267172	⌚	
25	271351979	⌚	271351979	⌚	271351979	⌚	271351979	⌚	271351979	⌚	

No	Ø160 Kod /Code	Fiyat (Adet) Price (Pcs)	Ø200-Ø225 Kod /Code	Fiyat (Adet) Price (Pcs)	Ø250-Ø280 Kod /Code	Fiyat (Adet) Price (Pcs)	Ø315 Kod /Code	Fiyat (Adet) Price (Pcs)	Ø400 Kod /Code	Fiyat (Adet) Price (Pcs)	
1	700016026	⌚	700020026	⌚	700025026	⌚	700031526	⌚	700040026	⌚	
2	700016027	⌚	700020027	⌚	700025027	⌚	700031527	⌚	700040027	⌚	
3	700016028	⌚	700020028	⌚	700025028	⌚	700031528	⌚	700040028	⌚	
4	202050902	⌚	202051102	⌚	202051102	⌚	202053152	⌚			
5	2021501409	⌚	2021501409	⌚	2021501409	⌚	2021501409	⌚			
6	291131104	⌚	2911392004	⌚	2911392004	⌚	2911393154	⌚			
7	291131105	⌚	291132005	⌚	291132005	⌚	291133154	⌚			
8	201151969	⌚	201151969	⌚	201151969	⌚	201151969	⌚			
9	400267952	⌚	400267952	⌚	400267952	⌚	400267952	⌚			
10	400261112	⌚	400262002	⌚	400262002	⌚	400263152	⌚			
11	201151979	⌚	201151979	⌚	201151979	⌚	201151979	⌚			
12	400267182	⌚	400267200	⌚	400267200	⌚	400267200	⌚			
13	201011115	⌚	201012005	⌚	202502805	⌚	201019991	⌚			
EPDM	14	201999998	⌚	2010322542	⌚	2010322542	⌚	201031595	⌚		
FPM	14	201999990									
EPDM	15	K002037799	⌚	2010322549	⌚	2010325050	⌚	2010331549	⌚		
FPM	15	K002037790	⌚	2010322540	⌚	2010325040	⌚		⌚		
EPDM	16	201021609	⌚	2010322544	⌚	201032899	⌚	2010331544	⌚		
FPM	16	201021600	⌚	2010322500	⌚	201032800	⌚		⌚		
17	102310209	⌚	1023101029	⌚	1023101029	⌚	1023101029	⌚			
18	40160942	⌚	401252002	⌚	401252502	⌚	400315942	⌚			
19	201137106	⌚	20137205	⌚	20132804	⌚	201133154	⌚			
20	201016005	⌚	212520005	⌚	201028005	⌚	201013156	⌚			
21	201041604	⌚	201042004	⌚	201042804	⌚	201043154	⌚			
22	102310699	⌚	1023101129	⌚	1023101129	⌚	1023101139	⌚			
23	102310259	⌚	201120225	⌚	201120225	⌚	2011200315	⌚			
24	400267172	⌚	400267225	⌚	400267225	⌚	400267315	⌚			
25	271351979	⌚	271351979	⌚	271351979	⌚	271351979	⌚	271351979	⌚	

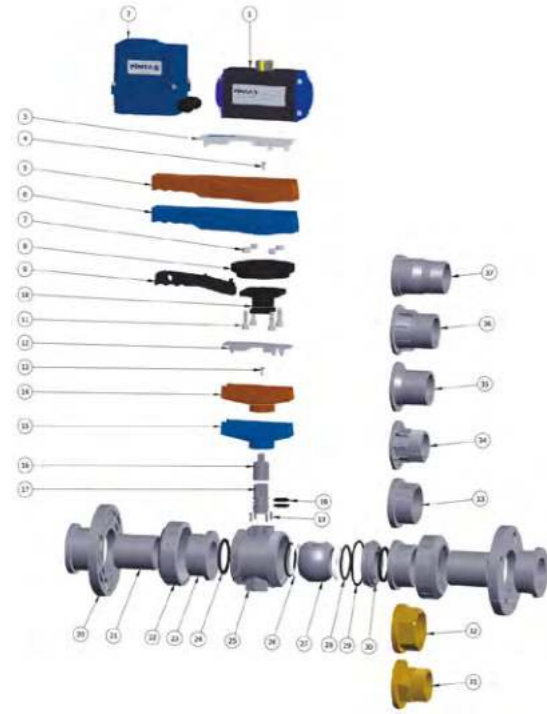
U-PVC Küresel Vana Yedek Parça Listesi
 U-PVC True Union Ball Valves Spare Parts List

No	Parça Part	Malzeme Material	Adet QTY
1	Pnömatik Akuator		1
2	Elektrikli Akuator		1
3	Kol Kapağı / Handle Cover	PVC	1
4	Civata / Screw	INOX	1
5	Kol / Handle (ASİT VANA KOL)	ABS	1
6	Kol / Horle / (SU VANA KOL)	ABS	1
7	Somun / Nut	INOX	4
8	Çark / Index Plate	PP GF	1
9	Mandal / Lever Catch	PP GF	1
10	Adaptör Ara Parça	U-PVC	1
11	ISO 4762 M8 x 25 --- 255	INOX	4
12	Kol Kapağı / Handle Cover	ABS	1
13	Civata / Screw	INOX	1
14	Kol Handle (ASİT)	ABS	1
15	Kol Handle (SU)	ABS	1
16	Pim Uzatma Parçası	U-PVC	1
17	Pim / Step	U-PVC	1
18	Pim O-Ringi / Step O-Ring	EPDM / FPM	2
19	Vida / Screw	INOX	4

No	Parça Part	Malzeme Material	Adet QTY
20	Flanş / Flange	U-PVC	2
21	Kole Ara Parça	U-PVC	2
22	Somun / Union Nut	U-PVC	2
23	Adaptör	U-PVC	4
24	Gövde O-Ringi / Body O-Ring	EPDM / FPM	2
25	Gövde / Body	U-PVC	1
26	Conta / Gasket	HDPE	2
27	Küre / Ball	U-PVC	1
28	Conta Altı O-Ring / Backing Seals	EPDM / FPM	2
29	Dayama O-Ring	EPDM / FPM	1
30	Küre Dayama / Union Brush	U-PVC	1
31	Dış Dış Adaptör	BRASS	1
32	İç Dış Adaptör	BRASS	1
33	İç Dişli Adaptör	U-PVC	1
34	Dış Dişli Adaptör	U-PVC	1
35	Adaptör	HDPE	1
36	Dış Yapıştırma Adaptör	U-PVC	1
37	Hortum Adaptörü	U-PVC	1



No	Ø20 Kod /Code	Fiyat (Adet) Price (Pcs)	Ø25 Kod /Code	Fiyat (Adet) Price (Pcs)	Ø32 Kod /Code	Fiyat (Adet) Price (Pcs)	Ø40 Kod /Code	Fiyat (Adet) Price (Pcs)	Ø50 Kod /Code	Fiyat (Adet) Price (Pcs)
1	700002026	⌚	700002526	⌚	700003226	⌚	700004026	⌚	700006326	⌚
2	700002027	⌚	700002527	⌚	700003227	⌚	700004027	⌚	700005027	⌚
3										
4										
5										
6										
7										
8										
9										
10	201600202	⌚	201600202	⌚	201600322	⌚	201600322	⌚	201600502	⌚
11	K00201479	⌚	K00201479	⌚	K00201479	⌚	K00201479	⌚	K00201479	⌚
12	202050202	⌚	202050202	⌚	202050322	⌚	202050405	⌚	202050502	⌚
13	100304199	⌚	100304199	⌚	100304199	⌚	100304199	⌚	100304199	⌚
14	205040202	⌚	205040202	⌚	205040322	⌚	205040402	⌚	205040502	⌚
15	202040202	⌚	202040202	⌚	202040322	⌚	202040402	⌚	202040502	⌚
16	202090251	⌚	202090251	⌚	202090321	⌚	202090321	⌚	202090501	⌚
17	202090202	⌚	202090202	⌚	202090322	⌚	202090322	⌚	202090502	⌚
EPDM 18	202100209	⌚	202100209	⌚	202100329	⌚	202100329	⌚	202100509	⌚
FPM 18	205100209	⌚	205100209	⌚	205100329	⌚	205100329	⌚	205100509	⌚
19										
20	513000202	⌚	513000252	⌚	513000322	⌚	513000402	⌚	513000502	⌚
21	201610202	⌚	201610252	⌚	201610322	⌚	201610402	⌚	201610502	⌚
22	202010202	⌚	202010252	⌚	202010322	⌚	202010402	⌚	202010502	⌚
23	512000202	⌚	512000252	⌚	512000322	⌚	512000402	⌚	512000502	⌚
EPDM 24	202030209	⌚	202030259	⌚	202100909	⌚	202030409	⌚	202030509	⌚
FPM 24	205030209	⌚	205030259	⌚	202100909	⌚	205030409	⌚	205030509	⌚
25	202060202	⌚	202060252	⌚	202060322	⌚	202060402	⌚	202060502	⌚
26	202080202	⌚	202080252	⌚	202080322	⌚	202080402	⌚	202080502	⌚
27	202110202	⌚	202110252	⌚	202110322	⌚	202110402	⌚	202110502	⌚
EPDM 28	202070209	⌚	202070259	⌚	202070329	⌚	202120259	⌚	202070509	⌚
FPM 28	205070209	⌚	205070259	⌚	205070329	⌚	205120259	⌚	205070509	⌚
EPDM 29	202120209	⌚	202120259	⌚	202120329	⌚	202120409	⌚	202070639	⌚
FPM 29	205120209	⌚	205120259	⌚	205120329	⌚	205120409	⌚	205070639	⌚
30	202130202	⌚	202130253	⌚	202130323	⌚	202130402	⌚	202130503	⌚
31	202170202	⌚	202170252	⌚	202170322	⌚	202170402	⌚	202170502	⌚
32	202180202	⌚	202180252	⌚	202180322	⌚	202180402	⌚	202180502	⌚
33	512020202	⌚	512020252	⌚	512020322	⌚	512020402	⌚	512020502	⌚
34	229060202	⌚	229060252	⌚	229060322	⌚	229060402	⌚	229060502	⌚
35	900900202	⌚	900900252	⌚	900900322	⌚	900900402	⌚	900900502	⌚
36	512300202	⌚	512300252	⌚	512300322	⌚	512300402	⌚	512300502	⌚
37	512600202	⌚	512600252	⌚	512600322	⌚	512600402	⌚	512600502	⌚

No	Ø63 Kod /Code	Fiyat (Adet) Price (Pcs)	Ø75 Kod /Code	Fiyat (Adet) Price (Pcs)	Ø90 Kod /Code	Fiyat (Adet) Price (Pcs)	Ø110 Kod /Code	Fiyat (Adet) Price (Pcs)
1	700006326	⌚	700007526	⌚	700009026	⌚	700011026	⌚
2	700006327	⌚	700007527	⌚	700009027	⌚	700011027	⌚
3	202050632	⌚	202050902	⌚	202050902	⌚	202051102	⌚
4	2021501499	⌚	2021501499	⌚	2021501499	⌚	2021501499	⌚
5	291130905	⌚	291130905	⌚	291130905	⌚	291131105	⌚
6	291139904	⌚	291139904	⌚	291139904	⌚	291131104	⌚
7	201151969	⌚	201151969	⌚	201151969	⌚	201151969	⌚
8	400267952	⌚	400267952	⌚	400267952	⌚	400267952	⌚
9	400267962	⌚	400267962	⌚	400267962	⌚	400267962	⌚
10	201600752	⌚	201600752	⌚	201600902	⌚	201600902	⌚
11	K00201479	⌚	K00201479	⌚	K00201479	⌚	K00201479	⌚
12	202050632	⌚	202050752	⌚	202050902	⌚	202051102	⌚
13	100300749	⌚	100300749	⌚	100300749	⌚	100300749	⌚
14	205040632	⌚	205040752	⌚	205040902	⌚	205041102	⌚
15	202040632	⌚	202040752	⌚	202040902	⌚	202041102	⌚
16	202090631	⌚	202090631	⌚	202090901	⌚	202090901	⌚
17	202090632	⌚	202090632	⌚	202090902	⌚	202090902	⌚
EPDM 18	202100639	⌚	202100639	⌚	202100909	⌚	202100909	⌚
FPM 18	205100639	⌚	205100639	⌚	205100909	⌚	205100909	⌚
19	201150639	⌚	201150759	⌚	201150759	⌚	201150909	⌚
20	513000632	⌚	513000752	⌚	513000902	⌚	513001102	⌚
21	201610632	⌚	201610752	⌚	201610902	⌚	201611102	⌚
22	202010632	⌚	202010752	⌚	202010902	⌚	202011102	⌚
23	512000632	⌚	512000752	⌚	512000902	⌚	512001102	⌚
EPDM 24	202030639	⌚	202030759	⌚	202030909	⌚	202031109	⌚
FPM 24	202030639	⌚	205030759	⌚	205030909	⌚	205031109	⌚
25	202060632	⌚	202060752	⌚	202060902	⌚	20501109	⌚
26	202080632	⌚	202080752	⌚	202080902	⌚	202081102	⌚
27	202110632	⌚	202110752	⌚	202110902	⌚	202111102	⌚
EPDM 28	202070639	⌚	202070759	⌚	202070909	⌚	202071109	⌚
FPM 28	205070639	⌚	205070759	⌚	205070909	⌚	205071109	⌚
EPDM 29	202120639	⌚	202030909	⌚	202120909	⌚	202121109	⌚
FPM 29	205120639	⌚	205030909	⌚	205120909	⌚	205121109	⌚
30	202130633	⌚	202130753	⌚	202130903	⌚	202131102	⌚
31	202170632	⌚						
32	202180632	⌚						
33	512020632	⌚	512020752	⌚	512020902	⌚	512021102	⌚
34	229060632	⌚	229060752	⌚	229060902	⌚	229061102	⌚
35	900900632	⌚	900900752	⌚	900900902	⌚	900901102	⌚
36	512300632	⌚	512300752	⌚	512300902	⌚	512301102	⌚
37	512600632	⌚	512600752	⌚	512600902	⌚	512601102	⌚

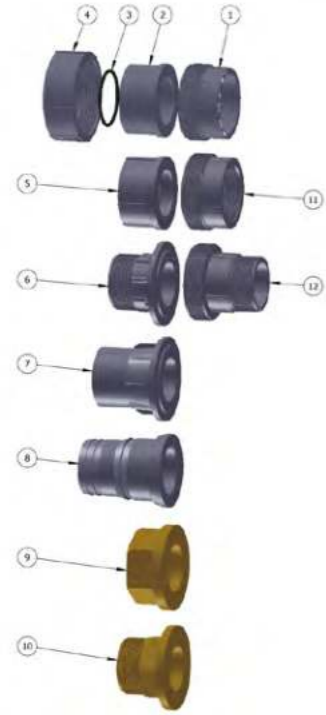
U-PVC Rakor Yedek Parça Listesi
 U-PVC Union Spare Parts List

No	Parça Part	Malzeme Material	Adet QTY
1	Rakor Gövde	U-PVC	1
2	Adaptör	U-PVC	1
3	Gövde O-Ring / Body O-Ring	EPDM / FPM	1
4	Somun / Nut	U-PVC	1
5	İç Diş Adaptör	U-PVC	1
6	Dış Diş Adaptör	U-PVC	1
7	Dış Yapıştırma Adaptör	U-PVC	1
8	Hortum Adaptörü	U-PVC	1
9	İç Diş Adaptör	BRASS	1
10	Dış Diş Adaptör	BRASS	1
11	İç Dişli Rakor Gövde	U-PVC	1
12	Dış Diş Rakor Gövde	U-PVC	1

No	Ø20 Kod /Code	Fiyat (Adet) Price (Pcs)	Ø25 Kod /Code	Fiyat (Adet) Price (Pcs)	Ø32 Kod /Code	Fiyat (Adet) Price (Pcs)	Ø40 Kod /Code	Fiyat (Adet) Price (Pcs)	Ø50 Kod /Code	Fiyat (Adet) Price (Pcs)
1	227050202	⌚	227050252	⌚	227050322	⌚	227050402	⌚	227050502	⌚
2	512000202	⌚	512000252	⌚	512000322	⌚	512000402	⌚	227010502	⌚
3	202030209	⌚	202030259	⌚	202100909	⌚	202030409	⌚	202030509	⌚
3	2050302096	⌚	205030259	⌚	205100909	⌚	205030409*	⌚	205030509	⌚
4	202010202	⌚	202010252	⌚	202010322	⌚	202010402	⌚	227020502	⌚
5	512020202	⌚	512020252	⌚	512020322	⌚	512020402	⌚	502020502	⌚
6										
7	512300202	⌚	512300252	⌚	512300322	⌚	512300402	⌚	512300502	⌚
8	512600202	⌚	512600252	⌚	512600322	⌚	512600402	⌚	512600502	⌚
9	202180202	⌚	202180252	⌚	202180322	⌚	202180402	⌚	202180502	⌚
10	202170202	⌚	202170252	⌚	202170322	⌚	202170402	⌚	202170502	⌚
11	229050202	⌚	229050252	⌚	229050322	⌚	229050402	⌚	229050502	⌚
12	229090202	⌚	229090252	⌚	229090322	⌚	229090402	⌚	229090502	⌚

No	Ø63 Kod /Code	Fiyat (Adet) Price (Pcs)	Ø75 Kod /Code	Fiyat (Adet) Price (Pcs)	Ø90 Kod /Code	Fiyat (Adet) Price (Pcs)	Ø110 Kod /Code	Fiyat (Adet) Price (Pcs)
1	227050632	⌚	227050752	⌚	227050902	⌚	227051102	⌚
2	227010632	⌚	512000752	⌚	512000902	⌚	512001102	⌚
3	202030639	⌚	202030759	⌚	202030909	⌚	202031109	⌚
3	205030639	⌚	205030759	⌚	205030909	⌚	406031109	⌚
4	227020632	⌚	227010752	⌚	227020902	⌚	202010902	⌚
5	512020632	⌚	512020752	⌚	512020902	⌚	512021102	⌚
6	229060632	⌚						
7	512300632	⌚	512300752	⌚	512300902	⌚	512301102	⌚
8	512600632	⌚	512600752	⌚	512600902	⌚	512601102	⌚
9	202180632	⌚						
10	202170632	⌚						
11	229050632	⌚	229050752	⌚	229050902	⌚	229051102	⌚
12	229090632	⌚	229090752	⌚	229090902	⌚	229091102	⌚

U-PVC Çıplak Çalparalı Çekvalf Yedek Parça Listesi
 U-PVC Wafer Check Valve Spare Parts List

No	Parça Part	Malzeme Material	Adet QTY
1	Gövde / Body	U-PVC	1
2	Klape O-Ringi / Carrier O-Ring	EPDM / FPM	1
3	Klape / Clack	U-PVC	1
4	Yay / Spring	Stainless Steel	1
5	Gövde O-Ringi / Body O-Ring	EPDM / FPM	2
6	Klape Tapası / Clack Plug	U-PVC	2

No	Ø63 Kod /Code	Fiyat (Adet) Price (Pcs)	Ø75 Kod /Code	Fiyat (Adet) Price (Pcs)	Ø90 Kod /Code	Fiyat (Adet) Price (Pcs)	Ø110 Kod /Code	Fiyat (Adet) Price (Pcs)	Ø125 Kod /Code	Fiyat (Adet) Price (Pcs)
1	221020632	⌚	221020752	⌚	221020902	⌚	221021102	⌚	221021252	⌚
2	221160908	⌚	221160759	⌚	221160909	⌚	221161109	⌚	221161259	⌚
3	221160631	⌚	221160751	⌚	221160901	⌚	221161101	⌚	221161251	⌚
3	221030632	⌚	221030752	⌚	221030902	⌚	221031102	⌚	221031252	⌚
4	221170639	⌚	221170759	⌚	221170909	⌚	221171109	⌚	221171259	⌚
5	221150908	⌚	221150759	⌚	221150909	⌚	221151109	⌚	221151259	⌚
5	2211506631	⌚	221150751	⌚	221150901	⌚	221151101	⌚	221151251	⌚
6	221120902	⌚	221120902	⌚	221120902	⌚	221121102	⌚	221121102	⌚

No	Ø140 Kod /Code	Fiyat (Adet) Price (Pcs)	Ø160 Kod /Code	Fiyat (Adet) Price (Pcs)	Ø200 Kod /Code	Fiyat (Adet) Price (Pcs)	Ø225 Kod /Code	Fiyat (Adet) Price (Pcs)
1	221021402	⌚	221021602	⌚	221022002	⌚	221022252	⌚
2	221161409	⌚	221161609	⌚	221162009	⌚	221162259	⌚
2	221161401	⌚	221161601	⌚	221162001	⌚	221162251	⌚
3	221031402	⌚	221031602	⌚	221032002	⌚	221032252	⌚
4	221171409	⌚	221171609	⌚	221172009	⌚	221172259	⌚
5	221151409	⌚	221151609	⌚	221152009	⌚	221152259	⌚
5	221151401	⌚	221151601	⌚	221152001	⌚	221152251	⌚
6	221121102	⌚	221121102	⌚	221121102	⌚	221121102	⌚

No	Ø250 Kod /Code	Fiyat (Adet) Price (Pcs)	Ø280 Kod /Code	Fiyat (Adet) Price (Pcs)	Ø315 Kod /Code	Fiyat (Adet) Price (Pcs)	Ø400 Kod /Code	Fiyat (Adet) Price (Pcs)
1	221022502	⌚	221022502	⌚	22102315252	⌚	221024002	⌚
2	221162509	⌚	221162509	⌚	221163151	⌚	221164009	⌚
2	221162501	⌚	221162501	⌚	221163151	⌚	221164001	⌚
3	221032502	⌚	221032502	⌚	22103315252	⌚	221034002	⌚
4	221172509	⌚	221172509	⌚	221173159	⌚	221174009	⌚
5	221152509	⌚	221152509	⌚	221153159	⌚	221154009	⌚
5	221152501	⌚	221152501	⌚	221153151	⌚	221154001	⌚
6	221122502	⌚	221122502	⌚	221122502	⌚	221122502	⌚

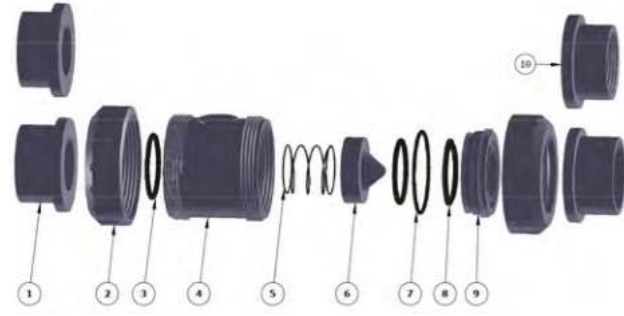
U-PVC Yaylı Çekvalfler Yedek Parça Listesi
 U-PVC True Union Spring Checkvalve Spare Parts List

No	Parça Part	Malzeme Material	Adet QTY
1	Kole	U-PVC	2
2	Somun / Union Nut	U-PVC	2
3	Gövde O-Ring	EPDM	2
4	Gövde / Body	U-PVC	1
5	Yay / Sprino	Stainless Stell 316	1
6	Klape / Valve	U-PVC	1
7	Dayama O-Ring	EPDM	1
8	Klape O-Ringi / Valve O-Ring	EPDM	1
9	Küre Dayama / Union Bush	U-PVC	1
10	İç Dişli Kole	U-PVC	2

No	Ø20 Kod /Code	Fiyat (Adet) Price (Pcs)	Ø25 Kod /Code	Fiyat (Adet) Price (Pcs)	Ø32 Kod /Code	Fiyat (Adet) Price (Pcs)	Ø40 Kod /Code	Fiyat (Adet) Price (Pcs)	Ø50 Kod /Code	Fiyat (Adet) Price (Pcs)
1	512000202	⌚	512000252	⌚	512000322	⌚	512000402	⌚	512000202	⌚
2	202010202	⌚	202010252	⌚	202010322	⌚	202010402	⌚	202010202	⌚
3	202030209	⌚	202030259	⌚	202100909	⌚	202030409	⌚	202030209	⌚
4	214040202	⌚	214040252	⌚	214040322	⌚	214040402	⌚	214040202	⌚
5	214050209	⌚	214050259	⌚	214040329	⌚	214050409	⌚	214050209	⌚
6	214060202	⌚	214060252	⌚	214060322	⌚	214060402	⌚	214060202	⌚
7	202120209	⌚	202120259	⌚	202120329	⌚	202120409	⌚	202120209	⌚
8	202070209	⌚	202070259	⌚	202070329	⌚	202120259	⌚	202070209	⌚
9	202130202	⌚	202130252	⌚	202130322	⌚	202130402	⌚	202130202	⌚
10	512020202	⌚	512020252	⌚	512020322	⌚	512020402	⌚	512020202	⌚

No	Ø63 Kod /Code	Fiyat (Adet) Price (Pcs)	Ø75 Kod /Code	Fiyat (Adet) Price (Pcs)	Ø90 Kod /Code	Fiyat (Adet) Price (Pcs)	Ø110 Kod /Code	Fiyat (Adet) Price (Pcs)
1	512000252	⌚	512000322	⌚	512000402	⌚	512001102	⌚
2	202010252	⌚	202010322	⌚	202010402	⌚	202011102	⌚
3	202030259	⌚	202100909	⌚	202030409	⌚	202031109	⌚
4	214040252	⌚	214040322	⌚	214040402	⌚	214041102	⌚
5	214050259	⌚	214040329	⌚	214050409	⌚	214051109	⌚
6	214060252	⌚	214060322	⌚	214060402	⌚	214061102	⌚
7	202120259	⌚	202120329	⌚	202120409	⌚	202121109	⌚
8	202070259	⌚	202070329	⌚	202120259	⌚	202071109	⌚
9	202130252	⌚	202130322	⌚	202130402	⌚	202131102	⌚
10	512020252	⌚	512020322	⌚	512020402	⌚	512021102	⌚

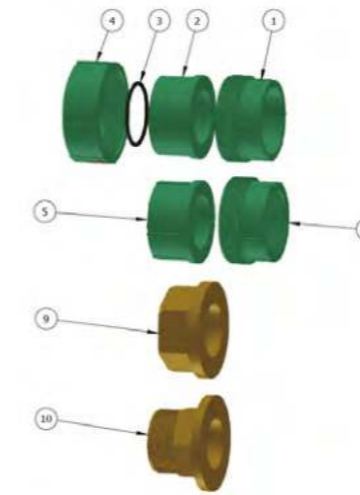
PP Rakor Yedek Parça Listesi
 PP Union Spare Parts List

No	Parça Part	Malzeme Material	Adet QTY
1	Rakor Gövde	PP	1
2	Adaptör	PP	1
3	Gövde O-Ring / Body O-Ring	EPDM / FPM	1
4	Somun / Nut	PP	1
5	İç Diş Adaptör	PP	1
9	İç Diş Adaptör	BRASS	1
10	Dış Diş Adaptör	BRASS	1
11	İç Dişli Rakor Gövde	PP	1

No	Ø20 Kod /Code	Fiyat (Adet) Price (Pcs)	Ø25 Kod /Code	Fiyat (Adet) Price (Pcs)	Ø32 Kod /Code	Fiyat (Adet) Price (Pcs)	Ø40 Kod /Code	Fiyat (Adet) Price (Pcs)	Ø50 Kod /Code	Fiyat (Adet) Price (Pcs)
1	406050202	⌚	406050252	⌚	406050322	⌚	406050402	⌚	406050502	⌚
2	512030202	⌚	512030252	⌚	512030322	⌚	512030402	⌚	406010502	⌚
3	202030209	⌚	202030259	⌚	202100909	⌚	202030409	⌚	202030509	⌚
4	2050302096	⌚	205030259	⌚	205100909	⌚	205030409	⌚	205030509	⌚
5	400010202	⌚	400010252	⌚	400010322	⌚	400010402	⌚	406020502	⌚
9	512240202	⌚	512240252	⌚	512240322	⌚	512240402	⌚	512240502	⌚
10	202180202	⌚	202180252	⌚	202180322	⌚	202180402	⌚	202180502	⌚
11	408050202	⌚	408050252	⌚	408050322	⌚	408050402	⌚	408050502	⌚

No	Ø63 Kod /Code	Fiyat (Adet) Price (Pcs)	Ø75 Kod /Code	Fiyat (Adet) Price (Pcs)	Ø90 Kod /Code	Fiyat (Adet) Price (Pcs)	Ø110 Kod /Code	Fiyat (Adet) Price (Pcs)
1	406050632	⌚	406050752	⌚	406050902	⌚	406051102	⌚
2	406010632	⌚	512030752	⌚	512030902	⌚	512031102	⌚
3	202030639	⌚	202030759	⌚	202030909	⌚	202031109	⌚
4	205030639	⌚	205030759	⌚	205030909	⌚	406031109	⌚
5	406020632	⌚	400010752	⌚	406020902	⌚	400010902	⌚
9	512240632	⌚	512240752	⌚	512240902	⌚	512241102	⌚
10	202180632	⌚						
11	408050632	⌚	408050752	⌚	408050902	⌚	408051102	⌚

PP Küresel Vana Yedek Parça Listesi
 PP True Union Ball Valves Spare Parts List



No	Parça Part	Malzeme Material	Adet QTY
1	Pnomatik Aktuatör		1
2	Elektrikli Aktuatör		1
3	Kol Kapağı / Handle Cover	PVC	1
4	Civata / Screw	INOX	1
5	Kol / Handle (ASİT VANA KOL)	ABS	1
6	Kol / Handle (SU VANA KOL)	ABS	1
7	Somun / Nut	INOX	4
8	Çark / Index Plate	PP GF	1
9	Mandal / Lever Catch	PP GF	1
10	Adaptör Ara Parça	PP	1
11	ISO 4762 M8 x 25 --- 25S	INOX	4
12	Kol Kapağı / Handle Cover	ABS	1
13	Civata / Screw	INOX	1
14	Kol / Handle (ASİT)	ABS	1
15	Kol / Handle (SU)	ABS	1
16	Pim Uzatma Parçası	PP	1
17	Pim / Step	PP	1
18	Pim O-Ringi / Step O-Ring	EPDM / FPM	2
19	Vida / Screw	INOX	4

No	Parça Part	Malzeme Material	Adet QTY
20	Flaş / Flange	PP	2
21	Kole Ara Parça	PP	2
22	Somun / Union Nut	PP	2
23	Adaptör	PP	4
24	Gövde O-Ringi / Body O-Ring	EPDM / FPM	2
25	Gövde / Body	PP	1
26	Conta / Gasket	TEFLON	2
27	Küre / Ball	PP	1
28	Conta Altı O-Ring / Backing Seals	EPDM / FPM	2
29	Dayama O-Ring	EPDM / FPM	1
30	Küre Dayama / Union Bush	PP	1
31	Dış Dış Adaptör	BRASS	1
32	İç Dış Adaptör	BRASS	1
33	İç Dişli Adaptör	PP	1
34	Dış Dişli Adaptör	PP	1
35	Adaptör	HDPE	1
36	Dış Yapıştırma Adaptör	PP	1
37	Hortum Adaptörü	PP	1

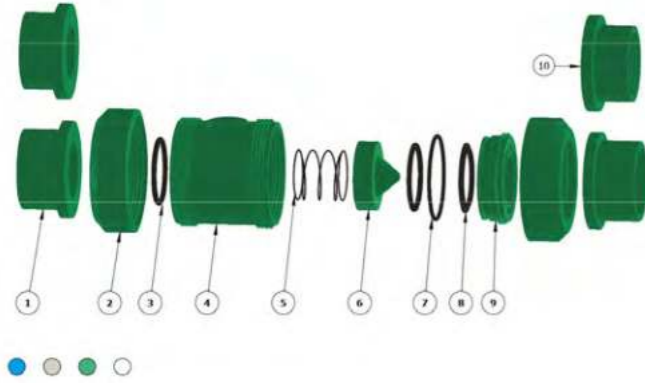

No	Ø20 Kod /Code	Fiyat (Adet) Price (Pcs)	Ø25 Kod /Code	Fiyat (Adet) Price (Pcs)	Ø32 Kod /Code	Fiyat (Adet) Price (Pcs)	Ø40 Kod /Code	Fiyat (Adet) Price (Pcs)	Ø50 Kod /Code	Fiyat (Adet) Price (Pcs)
1	700002026	⌚	700002526	⌚	700003226	⌚	700004026	⌚	700006326	⌚
2	700002027	⌚	700002527	⌚	700003227	⌚	700004027	⌚	700005027	⌚
3										
4										
5										
6										
7										
8										
9										
10	201600202	⌚	201600202	⌚	201600322	⌚	201600322	⌚	201600502	⌚
11	K00201479	⌚	K00201479	⌚	K00201479	⌚	K00201479	⌚	K00201479	⌚
12	202050202	⌚	202050202	⌚	202050322	⌚	202050402	⌚	202050502	⌚
13	100304199	⌚	100304199	⌚	100304199	⌚	100304199	⌚	100304199	⌚
14	205040202	⌚	205040202	⌚	205040322	⌚	205040402	⌚	205040502	⌚
15	202040202	⌚	202040202	⌚	202040322	⌚	202040402	⌚	202040502	⌚
16	202090251	⌚	202090251	⌚	202090321	⌚	202090321	⌚	202090501	⌚
17	400090202	⌚	400090202	⌚	400090322	⌚	400090322	⌚	400090502	⌚
18	202100209	⌚	202100209	⌚	202100329	⌚	202100329	⌚	202100509	⌚
19	205100209	⌚	205100209	⌚	205100329	⌚	205100329	⌚	205100509	⌚
20	513010202	⌚	513010252	⌚	513010322	⌚	513010402	⌚	513010502	⌚
21	201310202	⌚	201310252	⌚	201310322	⌚	201310402	⌚	201310502	⌚
22	400010202	⌚	400010252	⌚	400010322	⌚	400010402	⌚	400010502	⌚
23	512030202	⌚	512030252	⌚	512030322	⌚	512030402	⌚	512030502	⌚
24	202030209	⌚	202030259	⌚	202100909	⌚	202030409	⌚	202030509	⌚
25	205030209	⌚	205030259	⌚	202100909	⌚	205030409	⌚	205030509	⌚
26	400060202	⌚	400060252	⌚	400060322	⌚	400060402	⌚	400060502	⌚
27	205080209	⌚	205080259	⌚	205080329	⌚	205080409	⌚	205080509	⌚
28	400110202	⌚	400110252	⌚	400110322	⌚	400110402	⌚	400110502	⌚
29	202070209	⌚	202070259	⌚	202070329	⌚	202120259	⌚	202070509	⌚
30	205070209	⌚	205070259	⌚	205070329	⌚	205120259	⌚	205070509	⌚
31	202120209	⌚	202120259	⌚	202120329	⌚	202120409	⌚	202070639	⌚
32	205120209	⌚	205120259	⌚	205120329	⌚	205120409	⌚	205070639	⌚
33	400130202	⌚	400130252	⌚	400130322	⌚	400130402	⌚	400130502	⌚
34	202170202	⌚	202170252	⌚	202170322	⌚	202170402	⌚	202170502	⌚
35	202180202	⌚	202180252	⌚	202180322	⌚	202180402	⌚	202180502	⌚
36	512040202	⌚	512040252	⌚	512040322	⌚	512040402	⌚	512040502	⌚
37	229100202		229100252		229100322		229100402		229100502	
38	758160209		758160259		758160329		758160409		758160509	
39	512310202		512310252		512310322		512310402		512310502	
40	512610202		512610252		512610322		512610402		512610502	

No	Ø63 Kod /Code	Fiyat (Adet) Price (Pcs)	Ø75 Kod /Code	Fiyat (Adet) Price (Pcs)	Ø90 Kod /Code	Fiyat (Adet) Price (Pcs)	Ø110 Kod /Code	Fiyat (Adet) Price (Pcs)
1	70006326	⌚	70007526	⌚	70009026	⌚	700011026	⌚
2	70006327	⌚	70007527	⌚	70009027	⌚	700011027	⌚
3	2022050632	⌚	2022050752	⌚	2022050902	⌚	2022051102	⌚
4	202501499	⌚	202501499	⌚	202501499	⌚	202501499	⌚
5	291130905	⌚	291130905	⌚	291130905	⌚	291131105	⌚
6	291139904	⌚	291139904	⌚	291139904	⌚	291131104	⌚
7	201151969	⌚	201151969	⌚	201151969	⌚	201151969	⌚
8	400267952	⌚	400267952	⌚	400267952	⌚	400267952	⌚
9	400267962	⌚	400267962	⌚	400267962	⌚	400267962	⌚
10	201600752	⌚	201600752	⌚	201600902	⌚	201600902	⌚
11	K00201479	⌚	K00201479	⌚	K00201479	⌚	K00201479	⌚
12	202050632	⌚	202050752	⌚	202050902	⌚	202051102	⌚
13	100300749	⌚	100300749	⌚	100300749	⌚	100300749	⌚
14	205040632	⌚	205040752	⌚	205040902	⌚	205041102	⌚
15	202040632	⌚	202040752	⌚	202040902	⌚	202041102	⌚
16	202090631	⌚	202090631	⌚	202090901	⌚	202090901	⌚
17	400090632	⌚	400090632	⌚	400090902	⌚	400090902	⌚
18	202100639	⌚	202100639	⌚	202100909	⌚	202100909	⌚
19	205100639	⌚	205100639	⌚	205100909	⌚	205100909	⌚
20	513010632	⌚	513010752	⌚	513010902	⌚	513011102	⌚
21	201310632	⌚	201310752	⌚	201310902	⌚	201311102	⌚
22	400010632	⌚	400010752	⌚	400010902	⌚	400111102	⌚
23	512030632	⌚	512030752	⌚	512030902	⌚	512031102	⌚
24	202030639	⌚	202030759	⌚	202030909	⌚	202031109	⌚
25	205030639	⌚	205030759	⌚	205030909	⌚	205031109	⌚
26	400060632	⌚	400060752	⌚	400060902	⌚	400061102	⌚
27	205080639	⌚	205080759	⌚	205080909	⌚	205081109	⌚
28	400110632	⌚	400110752	⌚	400110902	⌚	400111102	⌚
29	202070639	⌚	202070759	⌚	202070909	⌚	202071109	⌚
30	205070639	⌚	205070759	⌚	205070909	⌚	205071109	⌚
31	202120639	⌚	202030909	⌚	202120909	⌚	202121109	⌚
32	205120639	⌚	205030909	⌚	205120909	⌚	205121109	⌚
33	400130632	⌚	400130752	⌚	400130902	⌚	400131102	⌚
34	202170632	⌚						
35	202180632	⌚						
36	512040632	⌚	512040752	⌚	512040902	⌚	512041102	⌚
37	229100632	⌚	229100752	⌚	229100902	⌚	229101102	⌚
38	758160639	⌚	7581600012	⌚	758160909	⌚	758161109	⌚
39	512310632	⌚	512310752	⌚	512310902	⌚	512311102	⌚
40	512610632	⌚	512610752	⌚	512610902	⌚	512611102	⌚

PP Yaylı Çekvalfler Yedek Parça Listesi
 PP True Union Spring Checkvalve Spare Parts List

No	Parça Part	Malzeme Material	Adet QTY
1	Somun / Union Nut	PPRC	2
2	Bağl. Parçası / End Connector	PPRC	2
3	Bağl. Parçası / End Connector Thr.	PPRC	2
4	Gövde O-Ringi / Body O-Ring	EPDM	2
5	Gövde / Body	PPRC	1
6	Yay / Spring	INOX	1
7	Subap / Subap	PPRC	1
8	Subap O-Ringi / Carrier O-Ring	EPDM	1
9	Subap Dayama / Valve Bush	PPRC	1
10	Sıkıştırma O-Ringi / Carrier O-Ring	EPDM	1

No	Ø20 Kod /Code	Fiyat (Adet) Price (Pcs)	Ø25 Kod /Code	Fiyat (Adet) Price (Pcs)	Ø32 Kod /Code	Fiyat (Adet) Price (Pcs)	Ø40 Kod /Code	Fiyat (Adet) Price (Pcs)	Ø50 Kod /Code	Fiyat (Adet) Price (Pcs)
1	400010202	⌚	400010252	⌚	400010322	⌚	400010402	⌚	400010502	⌚
2	512030202	⌚	512030252	⌚	512030322	⌚	512030402	⌚	512030502	⌚
3	512040202	⌚	512040252	⌚	512040322	⌚	512040402	⌚	512040502	⌚
4	202030209	⌚	202030259	⌚	202100909	⌚	202030409	⌚	202030509	⌚
5	403040202	⌚	403040252	⌚	403040322	⌚	403040402	⌚	403040502	⌚
6	214050209	⌚	214050259	⌚	214050329	⌚	214050409	⌚	214050509	⌚
7	403060202	⌚	403060252	⌚	403060322	⌚	403060402	⌚	403060502	⌚
8	202070209	⌚	202070259	⌚	202070329	⌚	202070409	⌚	202070509	⌚
9	400130202	⌚	400130252	⌚	400130322	⌚	400130402	⌚	400130502	⌚
10	202120209	⌚	212120259	⌚	202120329	⌚	202120409	⌚	202070639	⌚

No	Ø63 Kod /Code	Fiyat (Adet) Price (Pcs)	Ø75 Kod /Code	Fiyat (Adet) Price (Pcs)	Ø90 Kod /Code	Fiyat (Adet) Price (Pcs)	Ø110 Kod /Code	Fiyat (Adet) Price (Pcs)
1	400010632	⌚	400010752	⌚	400010902	⌚	400011102	⌚
2	512030632	⌚	512030752	⌚	512030902	⌚	512031102	⌚
3	512040632	⌚	512040752	⌚	512040902	⌚	512041102	⌚
4	202030639	⌚	202030759	⌚	202030909	⌚	202031109	⌚
5	403040632	⌚	403040752	⌚	403040902	⌚	403041102	⌚
6	214050639	⌚	214050759	⌚	214050909	⌚	221171109	⌚
7	403060632	⌚	403060752	⌚	403060902	⌚	403061102	⌚
8	202070639	⌚	202070759	⌚	202070909	⌚	202071109	⌚
9	400130632	⌚	400130752	⌚	400130902	⌚	400131102	⌚
10	202120639	⌚	202030909	⌚	202120909	⌚	202121109	⌚

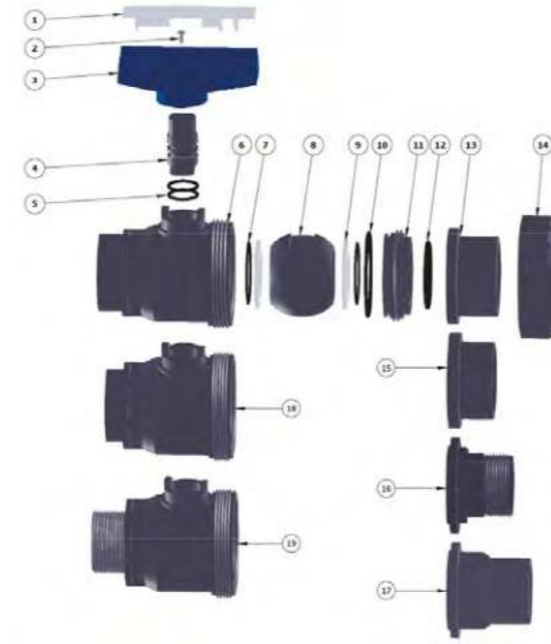
Tek Taraflı Tek Taraf Dişli Vana
 Single Union One Side Threaded Ball Valve

No	Parça Part	Malzeme Material	Adet QTY
1	Kol Kapağı / Handle Cover	U-PVC	1
2	Civata / Screw	INOX	1
3	Kol / Handle	ABS	1
4	Pim / Step	U-PVC	1
5	Pim O-Ring / Step O-Ring	EPDM	2
6	Gövde / Body	U-PVC	1
7	Conta Altı O-Ring / Backing Seals	EPDM	2
8	Küre / Ball	U-PVC	1
9	Küre Contası / Ball Gasket	HDPE	2
10	Dayama O-Ring	EPDM	1
11	Küre Dayama / Union Bush	U-PVC	1
12	Gövde O-Ring / Body O-Ring	EPDM	1
13	Adaptör	U-PVC	1
14	Somun / Union Nut	U-PVC	1
15	İç Dişli Adaptör	U-PVC	1
16	Dıştan Dişli Adaptör	U-PVC	1
17	İç Diş Yapıştırma Adaptör	U-PVC	1
18	İç Diş Gövde / Body	U-PVC	1
19	Dış Diş Gövde / Body	U-PVC	1

No	Ø20 Kod /Code	Fiyat (Adet) Price (Pcs)	Ø25 Kod /Code	Fiyat (Adet) Price (Pcs)	Ø32 Kod /Code	Fiyat (Adet) Price (Pcs)	Ø40 Kod /Code	Fiyat (Adet) Price (Pcs)	Ø50 Kod /Code	Fiyat (Adet) Price (Pcs)
1	202050202	⌚	202050202	⌚	202050322	⌚	202050402	⌚	202050502	⌚
2	100304199	⌚	100304199	⌚	100304199	⌚	100304199	⌚	202150329	⌚
3	202040202	⌚	202040202	⌚	202040322	⌚	202040402	⌚	202040502	⌚
4	202090202	⌚	202090202	⌚	202090322	⌚	202090322	⌚	202090502	⌚
5	202100209	⌚	202100209	⌚	202100329	⌚	202100329	⌚	202100509	⌚
6	232060202	⌚	232060252	⌚	232060322	⌚	232060402	⌚	232060502	⌚
7	202070209	⌚	202070259	⌚	202070329	⌚	202120259	⌚	202070509	⌚
8	202110202	⌚	202110252	⌚	202110322	⌚	202110402	⌚	202110502	⌚
9	202080202	⌚	202080252	⌚	202080322	⌚	202080402	⌚	202080502	⌚
10	202120209	⌚	202120259	⌚	202120329	⌚	202120409	⌚	202070639	⌚
11	202130202	⌚	202130252	⌚	202130322	⌚	202130402	⌚	202130502	⌚
12	202030209	⌚	202030259	⌚	202100909	⌚	202030409	⌚	202030509	⌚
13	512000202	⌚	512000252	⌚	512000322	⌚	512000402	⌚	512000502	⌚
14	202010202	⌚	202010252	⌚	202010322	⌚	202010402	⌚	202010502	⌚
15	512020202	⌚	512020252	⌚	512020322	⌚	512020402	⌚	512020502	⌚
16	229060202	⌚	229060252	⌚	229060322	⌚	229060402	⌚	229060502	⌚
17	512110202	⌚	512110252	⌚	512110322	⌚	512110402	⌚	512110502	⌚
18	232260202	⌚	232260252	⌚	232260322	⌚	232260402	⌚	232260502	⌚
19	232660202	⌚	232660252	⌚	232660322	⌚	232660402	⌚	232660502	⌚

No	Ø63 Kod /Code	Fiyat (Adet) Price (Pcs)	Ø75 Kod /Code	Fiyat (Adet) Price (Pcs)	Ø90 Kod /Code	Fiyat (Adet) Price (Pcs)	Ø110 Kod /Code	Fiyat (Adet) Price (Pcs)
1	202050632	⌚	202050752	⌚	202050902	⌚	202051102	⌚
2	202150329	⌚	202150329	⌚	202150329	⌚	202150329	⌚
3	202040632	⌚	202040752	⌚	202040902	⌚	202041102	⌚
4	202090632	⌚	202090632	⌚	202090902	⌚	202090902	⌚
5	202100639	⌚	202100639	⌚	202100909	⌚	202100909	⌚
6	232060632	⌚	232060752	⌚	232060902	⌚	232061102	⌚
7	202070639	⌚	202070759	⌚	202070909	⌚	202071109	⌚
8	202110632	⌚	202110752	⌚	202110902	⌚	202111102	⌚
9	202080632	⌚	202080752	⌚	202080902	⌚	202081102	⌚
10	202120639	⌚	202030909	⌚	202120909	⌚	202121109	⌚
11	202130632	⌚	202130752	⌚	202130902	⌚	202131102	⌚
12	202030639	⌚	202030759	⌚	202030909	⌚	202031109	⌚
13	512000632	⌚	512000752	⌚	512000902	⌚	512001102	⌚
14	202010632	⌚	202010752	⌚	202010902	⌚	202011102	⌚
15	512020632	⌚	512020752	⌚	512020902	⌚	512021102	⌚
16	229060632	⌚	229060752	⌚	229060902	⌚	229061102	⌚
17	512110632	⌚	512110752	⌚	512110902	⌚	512111102	⌚
18	232260632	⌚	232260752	⌚	232260902	⌚	232261102	⌚
19	232660632	⌚	232660752	⌚	232660902	⌚	232661102	⌚

Kaplin Yedek Parça Listesi PN 16
Spare Parts For Compression Fittings PN 16

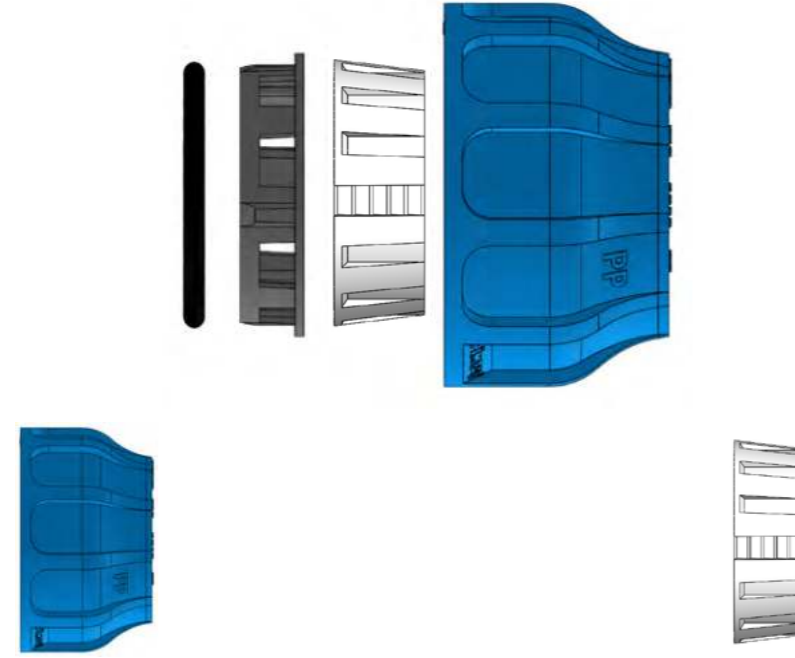

SOMUN / NUT

Çap Dia	Kod Code	Fiyat (Adet) Price (Pcs)	Poşet Adet Bag Pcs
20	EX232300202		1
25	EX232300252		1
32	EX232300322		1
40	EX232300402		1
50	EX232300502		1
63	EX232300632		1
75	EX232300752		1
90	EX232300902		1
110	EX232301102		1

POM KAPLİN SIKMA PARÇASI / LOCKING RING

Çap Dia	Kod Code	Fiyat (Adet) Price (Pcs)	Poşet Adet Bag Pcs
20	EX232110202		1
25	EX232110252		1
32	EX232110322		1
40	EX232110402		1
50	EX232110502		1
63	EX232110632		1
75	EX232110752		1
90	EX232110902		1
110	EX232111102		1



İÇ KOLE / O-RING HOLDER

Çap Dia	Kod Code	Fiyat (Adet) Price (Pcs)	Poşet Adet Bag Pcs
20	EX70100020		1
25	EX70100025		1
32	EX70100032		1
40	EX70100040		1
50	EX70100050		1
63	EX70100063		1
75	EX70100075		1
90	EX70100090		1
110	EX70100110		1

CONTA / O-RING

Çap Dia	Kod Code	Fiyat (Adet) Price (Pcs)	Poşet Adet Bag Pcs
20	EX70000209		100
25	EX70000259		100
32	EX70000329		100
40	EX70000409		100
50	EX70000509		100
63	EX70000639		100
75	EX70000759		50
90	EX70000909		50
110	EX700001109		50

Kaplin Yedek Parça Listesi PN10
Spare Parts For Compression Fittings PN10

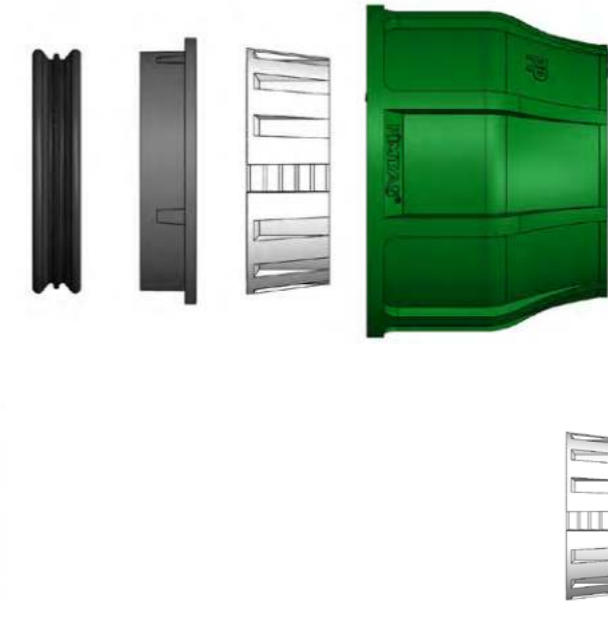

SOMUN / NUT

Çap Dia	Kod Code	Fiyat (Adet) Price (Pcs)	Poşet Adet Bag Pcs
20	GR232300202		1
25	GR232300252		1
32	GR232300322		1
40	GR232300402		1
50	GR232300502		1
63	GR232300632		1
75	GR232300752		1
90	GR232300902		1
110	GR232301102		1

POM KAPLİN SIKMA PARÇASI / LOCKING RING

Çap Dia	Kod Code	Fiyat (Adet) Price (Pcs)	Poşet Adet Bag Pcs
20	GR232110202		1
25	GR232110252		1
32	GR232110322		1
40	GR232110402		1
50	GR232110502		1
63	GR232110632		1
75	GR232110752		1
90	GR232110902		1
110	GR232111102		1



A MODEL

B MODEL

İÇ KOLE / O-RING HOLDER

Çap Dia	Kod Code	Fiyat (Adet) Price (Pcs)	Poşet Adet Bag Pcs
20	GR70100020		1
25	GR70100025		1
32	GR70100032		1
40	GR70100040		1
50	GR70100050		1
63	GR70100063		1
75	GR70100075		1
90	GR70100090		1
110	GR70100110		1

CONTA / O-RING

Çap Dia	Kod Code	Fiyat (Adet) Price (Pcs)	Poşet Adet Bag Pcs
20	GR70000209		100
25	GR70000259		100
32	GR70000329		100
40	GR70000409		100
50	GR70000509		100
63	GR70000639		100
75	GR70000759		50
90	GR70000909		50
110	GR700001109		50

A MODEL

B MODEL

PP Priz Kolye Yedek Parça Listesi
Spare Parts For Pp Clamp Saddle

PRİZ KOLYE GÖVDE ÜST
BODY OF CLAMP SADDLE (UPPER PART)

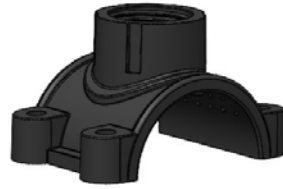

Çap Dia	R (mm)	Kod Code	Fiyat (Adet) Price (Pcs)	Poşet Adet Bag Pcs
25	1/2"	EX52931250202		1
32	1/2"	EX52931320202		1
32	3/4"	EX52931320252		1
32	1"	EX52931320322		1
40	1/2"	EX52931400202		1
40	3/4"	EX52931400252		1
40	1"	EX52931400322		1
50	1/2"	EX52931500202		1
50	3/4"	EX52931500252		1
50	1"	EX52931500322		1
50	1 1/4"	EX52931500402		1
50	1 1/2"	EX52931500502		1
63	1/2"	EX52931630202		1
63	3/4"	EX52931630252		1
63	1"	EX52931630322		1
63	1 1/4"	EX52931630402		1
63	1 1/2"	EX52931630502		1
75	1/2"	EX52931750202		1
75	3/4"	EX52931750252		1
75	1"	EX52931750322		1
75	1 1/4"	EX52931750402		1
75	1 1/2"	EX52931750502		1
75	2"	EX52931750632		1
90	1/2"	EX52931900202		1
90	3/4"	EX52931900252		1
90	1"	EX52931900322		1
90	1 1/4"	EX52931900402		1
90	1 1/2"	EX52931900502		1
90	2"	EX52931900632		1
110	1/2"	EX52931110202		1
110	3/4"	EX52931110252		1
110	1"	EX52931110322		1
110	1 1/4"	EX52931110402		1
110	1 1/2"	EX52931110502		1
110	2"	EX52931110632		1
125	1/2"	EX52931125202		1
125	3/4"	EX52931125252		1
125	1"	EX52931125322		1
125	1 1/4"	EX52931125402		1
125	1 1/2"	EX52931125502		1
125	2"	EX52931125632		1
140	1/2"	EX52931140202		1
140	3/4"	EX52931140252		1
140	1"	EX52931140322		1
140	1 1/4"	EX52931140402		1
140	1 1/2"	EX52931140502		1
140	2"	EX52931140632		1
160	1/2"	EX52931160202		1
160	3/4"	EX52931160252		1
160	1"	EX52931160322		1
160	1 1/4"	EX52931160402		1
160	1 1/2"	EX52931160502		1
160	2"	EX52931160632		1
200	1 1/2"	EX52931200502		1
200	2"	EX52931200632		1

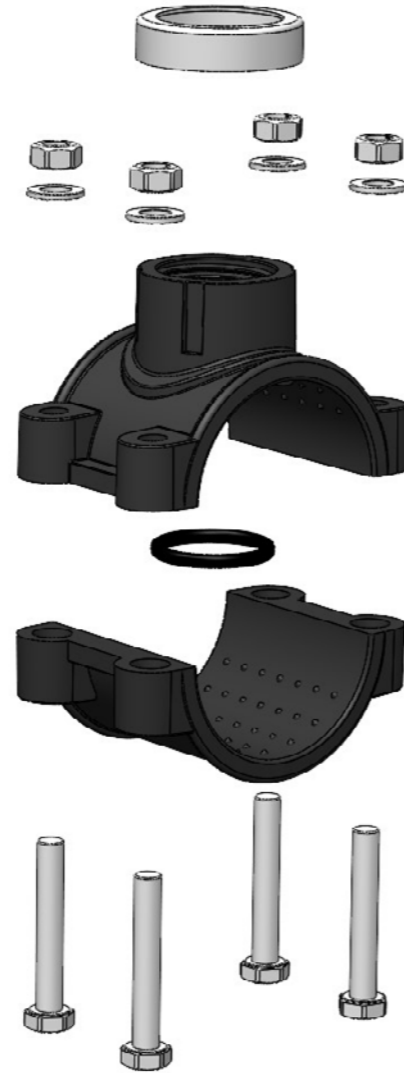

PRİZ KOLYE CONTASI
O-RING FOR CLAMP SADDLE

Çap Dia	Kod Code	Fiyat (Adet) Price (Pcs)	Poşet Adet Bag Pcs
25	EX221050258		100
32-40	EX221032408		100
50	EX221050508		100
63	EX221050638		100
75-90	EX221011057		50
110-125-140	EX221011062		50
160-200	EX221014065		50



SOMUN
NUT

Çap Dia	Kod Code	Fiyat (Adet) Price (Pcs)	Poşet Adet Bag Pcs
25-32-40-50	EX5290264014		100
63-75-90-110	EX529010034		100
125-140-160	EX529010034		100
200	EX201151910		100

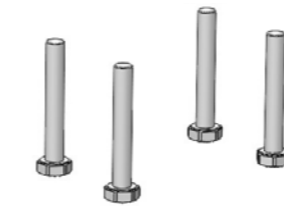

ÇİVATA
BOLT

Çap Dia	Kod Code	Fiyat (Adet) Price (Pcs)	Poşet Adet Bag Pcs
25-32-40-50	EX5290164014		100
63	EX529010014		100
75	EX529010017		100
90-110	EX529010018		100
125-140	EX529010019		100
160-200	EX529010010		100



PRİZ KOLYE GÖVDE ALTI
BODY OF CLAMP SADDLE (UNDER PART)

Çap Dia	Kod Code	Fiyat (Adet) Price (Pcs)	Poşet Adet Bag Pcs
25	EX52921250202		1
32	EX52921320252		1
40	EX52921400202		1
50	EX52921500202		1
63	EX52921630202		1
75	EX52921750202		1
90	EX52921900202		1
110	EX52921110202		1
125	EX52921125202		1
140	EX52921140202		1
160	EX52921160202		1
200	EX52921200202		1



PUL
REINFORCING RING

Çap Dia	Kod Code	Fiyat (Adet) Price (Pcs)	Poşet Adet Bag Pcs
25-32-40-50	EX5290364014		100
63-75-90-110	EX529010024		100
125-140-160	EX529010024		100
200	EXI00304500		100



METAL YÜZÜK
REINFORCING RING

Çap Dia	Kod Code	Fiyat (Adet) Price (Pcs)	Poşet Adet Bag Pcs
1/2"	SPCS0000001		1
3/4"	SPCS0000002		1
1"	SPCS0000003		1
1 1/4"	SPCS0000004		1
1 1/2"	SPCS0000005		1
2"	SPCS0000006		1



PIMTAS®

PLASTİK İNŞ. MALZ. SAN. VE TİC. A.Ş.



Алматы (7273)495-231
Ангарск (3955)60-70-56
Архангельск (8182)63-90-72
Астрахань (8512)99-46-04
Барнаул (3852)73-04-60
Белгород (4722)40-23-64
Благовещенск (4162)22-76-07
Брянск (4832)59-03-52
Владивосток (423)249-28-31
Владикавказ (8672)28-90-48
Владимир (4922)49-43-18
Волгоград (844)278-03-48
Вологда (8172)26-41-59
Воронеж (473)204-51-73
Екатеринбург (343)384-55-89

Иваново (4932)77-34-06
Ижевск (3412)26-03-58
Иркутск (395)279-98-46
Казань (843)206-01-48
Калининград (4012)72-03-81
Калуга (4842)92-23-67
Кемерово (3842)65-04-62
Киров (8332)68-02-04
Коломна (4966)23-41-49
Кострома (4942)77-07-48
Краснодар (861)203-40-90
Красноярск (391)204-63-61
Курск (4712)77-13-04
Курган (3522)50-90-47
Липецк (4742)52-20-81

Магнитогорск (3519)55-03-13
Москва (495)268-04-70
Мурманск (8152)59-64-93
Набережные Челны (8552)20-53-41
Нижний Новгород (831)429-08-12
Новокузнецк (3843)20-46-81
Ноябрьск (3496)41-32-12
Новосибирск (383)227-86-73
Омск (3812)21-46-40
Орел (4862)44-53-42
Оренбург (3532)37-68-04
Пенза (8412)22-31-16
Петрозаводск (8142)55-98-37
Псков (8112)59-10-37
Пермь (342)205-81-47

Ростов-на-Дону (863)308-18-15
Рязань (4912)46-61-64
Самара (846)206-03-16
Санкт-Петербург (812)309-46-40
Саратов (845)249-38-78
Севастополь (8692)22-31-93
Саранск (8342)22-96-24
Симферополь (3652)67-13-56
Смоленск (4812)29-41-54
Сочи (862)225-72-31
Ставрополь (8652)20-65-13
Сургут (3462)77-98-35
Сыктывкар (8212)25-95-17
Тамбов (4752)50-40-97
Тверь (4822)63-31-35

Тольятти (8482)63-91-07
Томск (3822)98-41-53
Тула (4872)33-79-87
Тюмень (3452)66-21-18
Ульяновск (8422)24-23-59
Улан-Удэ (3012)59-97-51
Уфа (347)229-48-12
Хабаровск (4212)92-98-04
Чебоксары (8352)28-53-07
Челябинск (351)202-03-61
Череповец (8202)49-02-64
Чита (3022)38-34-83
Якутск (4112)23-90-97
Ярославль (4852)69-52-93

Россия +7(495)268-04-70

Казахстан +7(7172)727-132

Киргизия +996(312)96-26-47

<https://pimtas.nt-rt.ru/> || pab@nt-rt.ru